

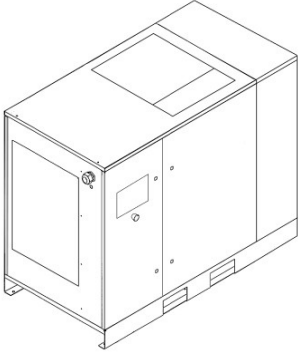
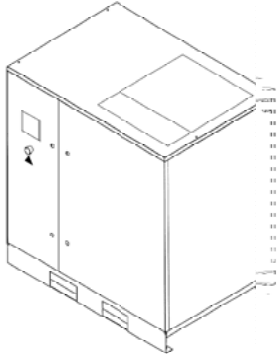

MANUAL USE AND MAINTENANCE

SILENCED ROTARY SCREW COMPRESSOR UNITS

HP 40 - 50 KW 30 - 37

Code	
9828093011	00
Edition 03/2015	



THIS MACHINE MUST BE CONNECTED TO TWO DIFFERENT POWER SUPPLIES: THREE-PHASE SUPPLY FOR THE COMPRESSOR SINGLE-PHASE SUPPLY FOR THE DRYER



READ THIS MANUAL CAREFULLY BEFORE ANY OPERATION ON THE COMPRESSOR UNIT.

CONTENTS	
PART A: INFORMATION FOR THE USER	
1.0 GENERAL FEATURES	17.0 SCRAPPING THE UNIT
2.0 INTENDED USE	18.0 LIST OF SPARE PARTS FOR ROUTINE MAINTENANCE
3.0 OPERATION	19.0 TROUBLE-SHOOTING AND EMERGENCY REMEDIES
4.0 GENERAL SAFETY STANDARDS	PART B: INFORMATION RESERVED FOR TECHNICALLY SKILLED PERSONNEL
5.0 DESCRIPTION OF DANGER WARNINGS	20.0 STARTING UP
6.0 DANGER ZONES	21.0 GENERAL ORDINARY MAINTENANCE REQUIRES TRAINED PERSONNEL
7.0 SAFETY DEVICES	22.0 CHANGING THE OIL
8.0 POSITION OF PLATES	23.0 CHANGING THE OIL FILTER AND OIL SEPARATOR FILTER
9.0 COMPRESSOR ROOM	24.0 OLEOPNEUMATIC DIAGRAM
10.0 TRANSPORT AND HANDLING	25.0 CALIBRATION FOR DRYER
11.0 UNPACKING	
12.0 INSTALLATION	
13.0 DIMENSIONS AND TECHNICAL DATA	
14.0 MACHINE DESCRIPTION	IMPORTANT: A COPY OF THE WIRING DIAGRAMS CAN BE FOUND IN THE ELECTRIC CABINET OF COMPRESSOR.
15.0 ORDINARY MAINTENANCE TO BE DONE BY THE USER	
16.0 PERIODS OF INACTIVITY	

MACHINE AND MANUFACTURER IDENTIFICATION DATA

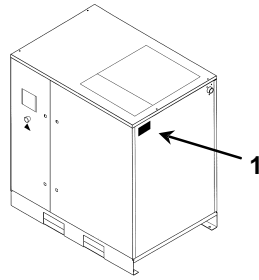

1) Position of the identification plate

ADDRESSES OF ASSISTANCE CENTRES

In the event of breakdown or malfunction of the machine, switch it off and do not tamper with it. If repairs are needed, apply only to a technical assistance centre approved by the manufacturer and insist on the use of original spare parts. Failure to comply with the above may endanger the safety of the machine.

INTRODUCTION

Keep this manual with care for future consultation; the use and maintenance manual is an integral part of the machine. Read this manual carefully before carrying out any work on the compressor unit.

The installation of the compressor unit and all operations involving it must be performed in conformity with the regulations in force concerning electric plants and personal safety.

CHARACTERISTICS AND SAFETY PRECAUTIONS



MACHINE WITH AUTOMATIC START

Lock Out – Tag Out (LOTO): Open the power isolating switch and lock it with a personal lock. Tag the power isolating switch with the name of the service technician.



BEFORE REMOVING THE PROTECTIVE GUARDS TO CARRY OUT ANY MAINTENANCE ON THE MACHINE, SWITCH OFF THE ELECTRIC POWER SUPPLY AND DISCHARGE THE RESIDUAL PRESSURE INSIDE THE UNIT.

ALL MAINTENANCE ON ELECTRICAL PARTS, MUST BE PERFORMED BY PROFESSIONALLY SKILLED PERSONNEL.

THIS MACHINE IS NOT SUITABLE FOR EXTERNAL INSTALLATION

THIS MACHINE CORRESPONDS TO THE ESSENTIAL SAFETY REQUIREMENTS FORESEEN FROM THE EUROPEAN STANDARD (2006/42 CE).

THE LUBRICATING LIQUIDS AND OTHER EVENTUAL FLUIDS MUST NOT BE DISCHARGED IN THE ENVIRONMENT. THESE POLLUTING AND HAZARDOUS PRODUCTS MUST COMPULSORY BE DISPOSED BY CHARGING AUTHORISED AND SPECIALISED FIRMS ACCORDING TO THE DIFFERENT TYPOLOGY OF PRODUCT. DIFFERENTIATE THE COMPRESSOR COMPONENTS ACCORDING TO THE DIFFERENT CONSTRUCTION MATERIALS (PLASTIC, COPPER, IRON, OIL FILTER, AIR FILTER ECC...)

The manufacturer does not accept responsibility for damage caused as a result of negligence or failure to abide by the instructions given above.

SAFETY VALVE:

The safety valves of the oil receiver must be checked every year and replaced in accordance with legislation in force.

NOT RESPECTING THE ABOVE MENTIONED PRESCRIPTION CAN RESULT IN AIR RECEIVER BURSTING HAZARD.

The manufacturer does not accept responsibility for damage caused as a result of negligence or failure to abide by the instructions given above.

1.0 GENERAL CHARACTERISTICS

The compressor units use single-stage screw rotary air compressors with oil injection.

The system is self-bearing and does not require bolts or other devices to anchor it to the floor.

The unit is completely assembled in the factory; the necessary connections for setting it up are:

- connection to the power mains (see installation chapter)
- connection to the compressed air network (see installation chapter)

2.0 INTENDED USE

The compressor has been built to supply compressed air for industrial use.

The machine cannot be used in premises where there is a risk of fire explosion or where work is carried out which releases substances into the environment which are dangerous with regard to safety (for example: solvents, inflammable vapours, alcohol, etc.).

In particular the appliance cannot be used to produce air to be breathed by humans or used on direct contact with foodstuffs. These uses are allowed if the compressed air produced is filtered by means of a suitable filtering system (Consult the manufacturer for these special uses.) This appliance must be used only for the purpose for which it was specifically designed.

All other uses are to be considered incorrect and therefore unreasonable.

The Manufacturer cannot be held responsible for any damage resulting from improper, incorrect or unreasonable use.

3.0 OPERATION

3.1 OPERATION FOR COMPRESSOR

The electric motor and the compressor unit are coupled by means of a gear transmission.

The compressor unit takes in the outside air through the suction valve. The air taken in is filtered by the cartridge fitted upstream from the suction valve. Inside the compressor unit, the air and the lubricating oil are compressed and sent to the oil separating tank where the oil is separated from the compressed air; the air is then filtered again by the oil separating cartridge to reduce the amount of suspended oil particles to a minimum. At this point the two flows (of oil and air) are sent to two separate coolers where they are cooled, using a flow of air taken from the environment by a special fan inside the machine.

The cooled oil returns to the reclaiming tank, and the compressed air leaves the machine via the outlet.

3.2 OPERATION FOR DRYER

Dryer operation is described below. The gaseous refrigerant coming from the evaporator (4) is sucked by the refrigeration compressor (1) and it is pumped into the condenser (2). This allows its condensation, eventually with the help of the fan (3); the condensed refrigerant passes through the dewatering filter (8) and it expands through the capillary tube (7) and goes back to the evaporator where it produces the refrigerating effect.

Due to the heat exchange with the compressed air which passes through the evaporator against the stream, the refrigerant evaporates and goes back to the compressor for a new cycle. The circuit is equipped with a bypass system for the refrigerant; this intervenes to adjust the available refrigerating capacity to the actual cooling load. This is achieved by injecting hot gas under the control of the valve (9): this valve keeps constant the pressure of the refrigerant in the evaporator and therefore also the dew point never decreases below 0 °C (32 °F) in order to prevent the condensate from freezing inside the evaporator.

The drier runs completely automatically; it is calibrated in the factory for a dew point of 5 °C (41 °F) and therefore no further calibrations are required.

DRYER FLOW DIAGRAM

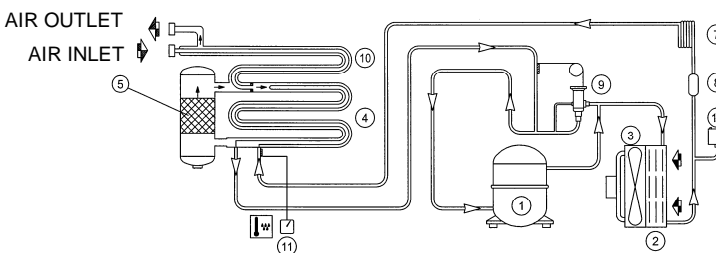

4.0 GENERAL SAFETY STANDARDS

The appliance may be used only by specially trained and authorized personnel.

Any tampering with the machine or alterations not approved beforehand by the Manufacturer relieve the latter of responsibility for any damage resulting from the above actions.









The removal of or tampering with the safety devices constitutes a violation of the European Standards on safety.

ATTENTION: UPSTREAM OF THE MACHINE INSTALL AN ISOLATOR KNIFE-SWITCH WITH AN AUTOMATIC CUTOFF AGAINST CURRENT SURGES AND EQUIPPED WITH A DIFFERENTIAL DEVICE FOR CALIBRATIONS SEE WIRING DIAGRAM.



ALL WORK ON THE ELECTRIC PLANT, HOWEVER SLIGHT, MUST BE CARRIED OUT BY PROFESSIONALLY SKILLED PERSONNEL.

5.0 DESCRIPTION OF DANGER SIGNALS

	1) FLUID EJECTION		6) HOT PARTS
	2) DANGEROUS ELECTRIC VOLTAGE		8) MOVING PARTS
	3) AIR NOT FIT FOR BREATHING		9) MACHINE WITH AUTOMATIC START
	4) NOISE		
	5) HIGH PRESSURE		

5.1 DESCRIPTION OF COMPULSORY SIGNALS

	11) READ THE USE AND MAINTENANCE INSTRUCTIONS		
---	---	--	--

6.0 DANGERS ZONES

6.1 DANGERS ZONES FOR COMPRESSOR UNIT

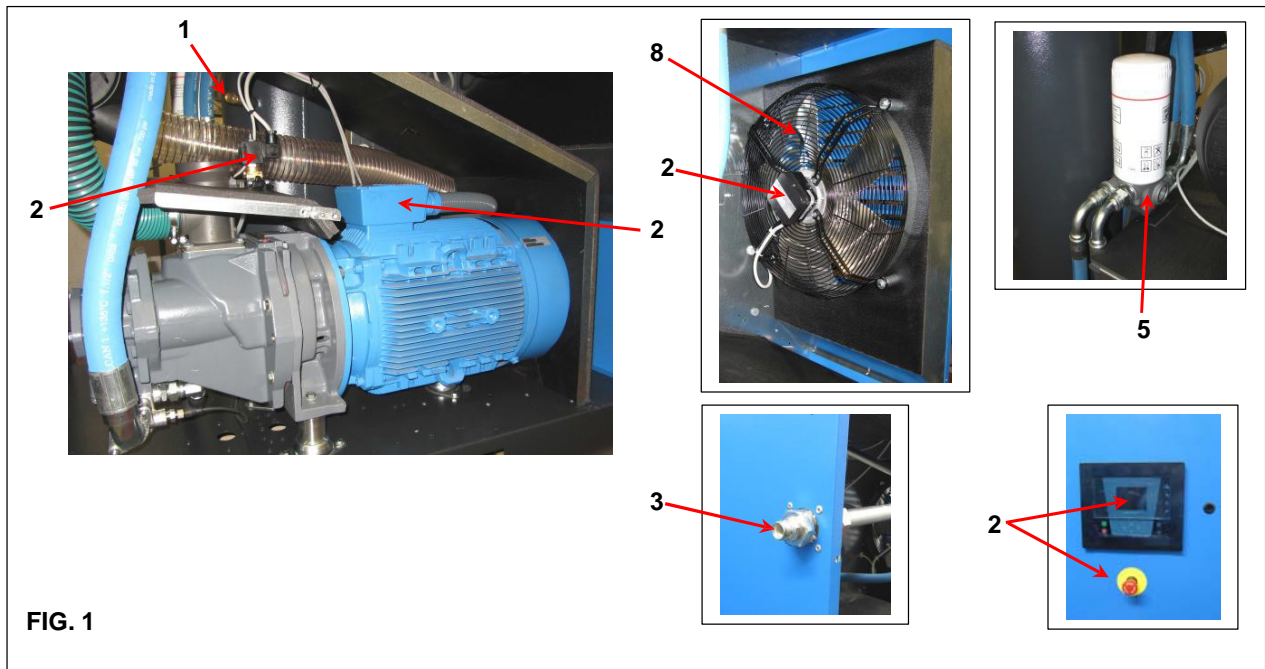
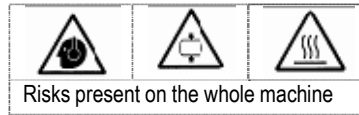

6.2 DANGERS ZONES FOR DRYER UNIT

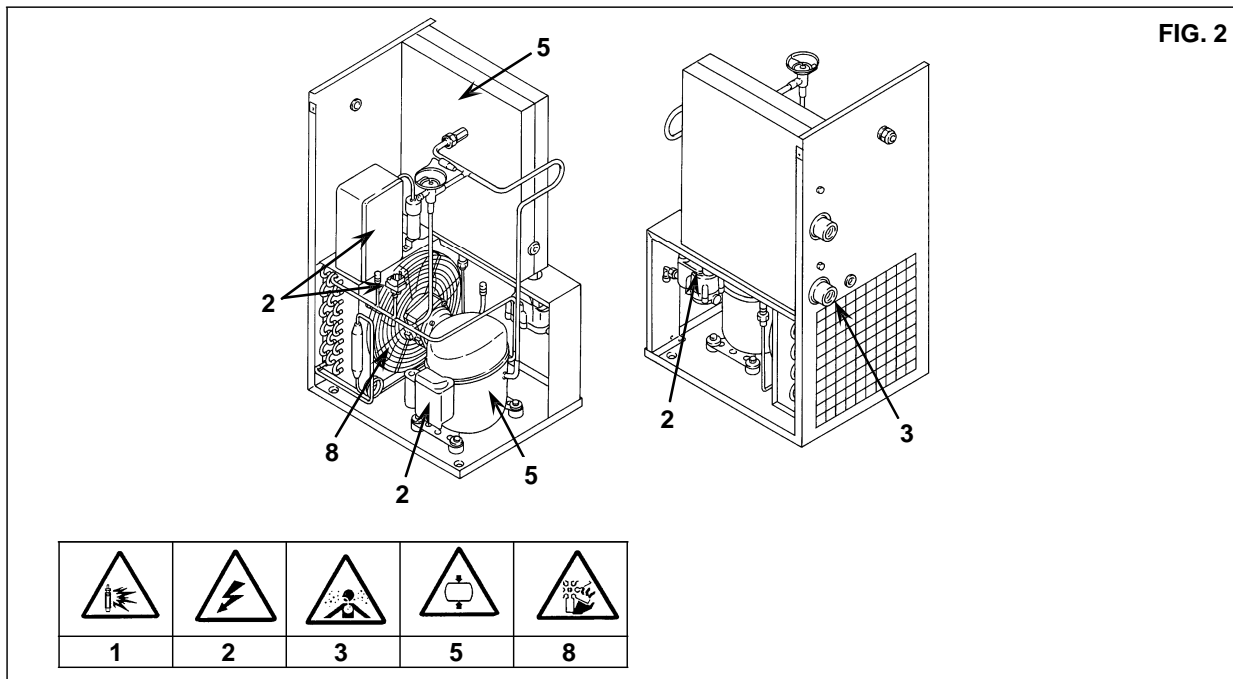
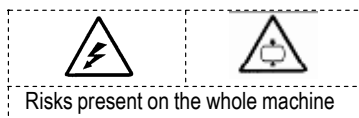

7.0 SAFETY DEVICES

7.1 SAFETY DEVICES FOR SCREW COMPRESSOR (Fig. 3)

1) Safety screws	4) Emergency stop button with mechanical seal and rotation release.
2) Side panels and door to the electric panel, opened with a special key	5) Oil filling cap (with safety breather)
3) Fixed protection device - cooling fan	6) Safety valve

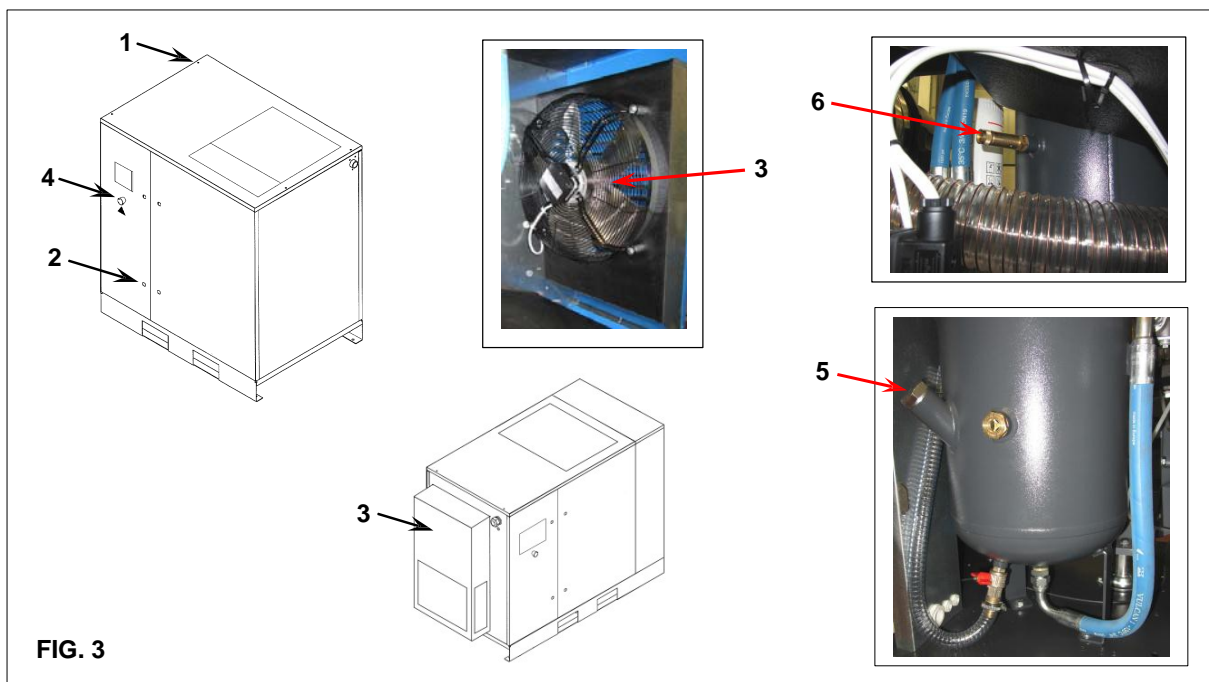

ENGLISH

7.2 SAFETY DEVICES FOR DRYER UNIT

1) Protective pressure switch cap.	4) Relay for compressor (automatic)
2) Earth	5) Overload protector for compressor
3) Fan protection	

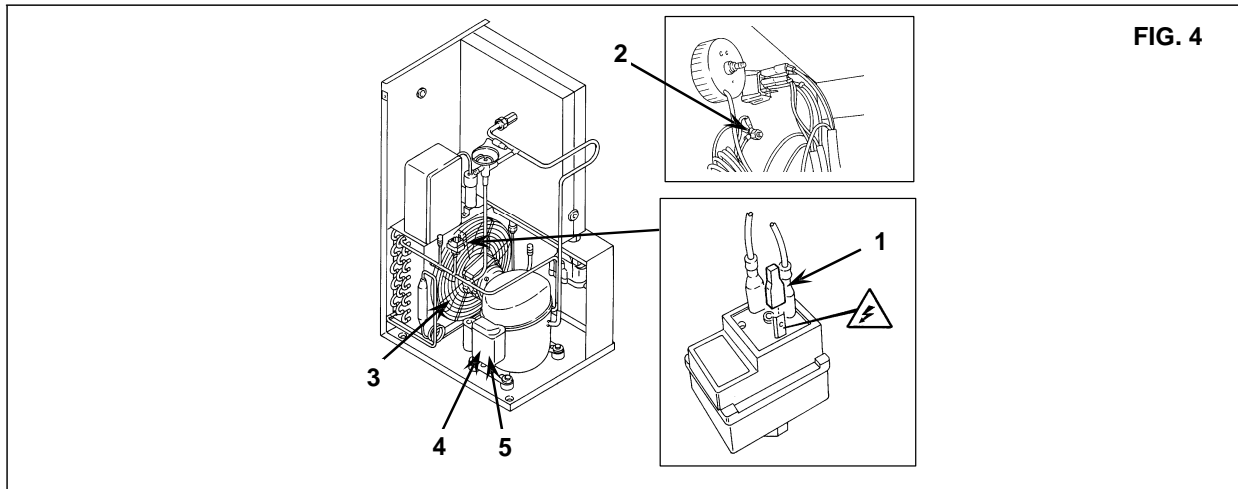

8.0 POSITION OF PLATES

8.1 POSITION OF THE DANGER PLATES FOR COMPRESSOR UNIT

The plates fitted on the compressor unit are part of the machine; they have been applied for safety purposes and must not be removed or spoiled for any reason.

1) Dangers plate Code 1079990348

2) Plate "Machine with automatic start" 2202260791

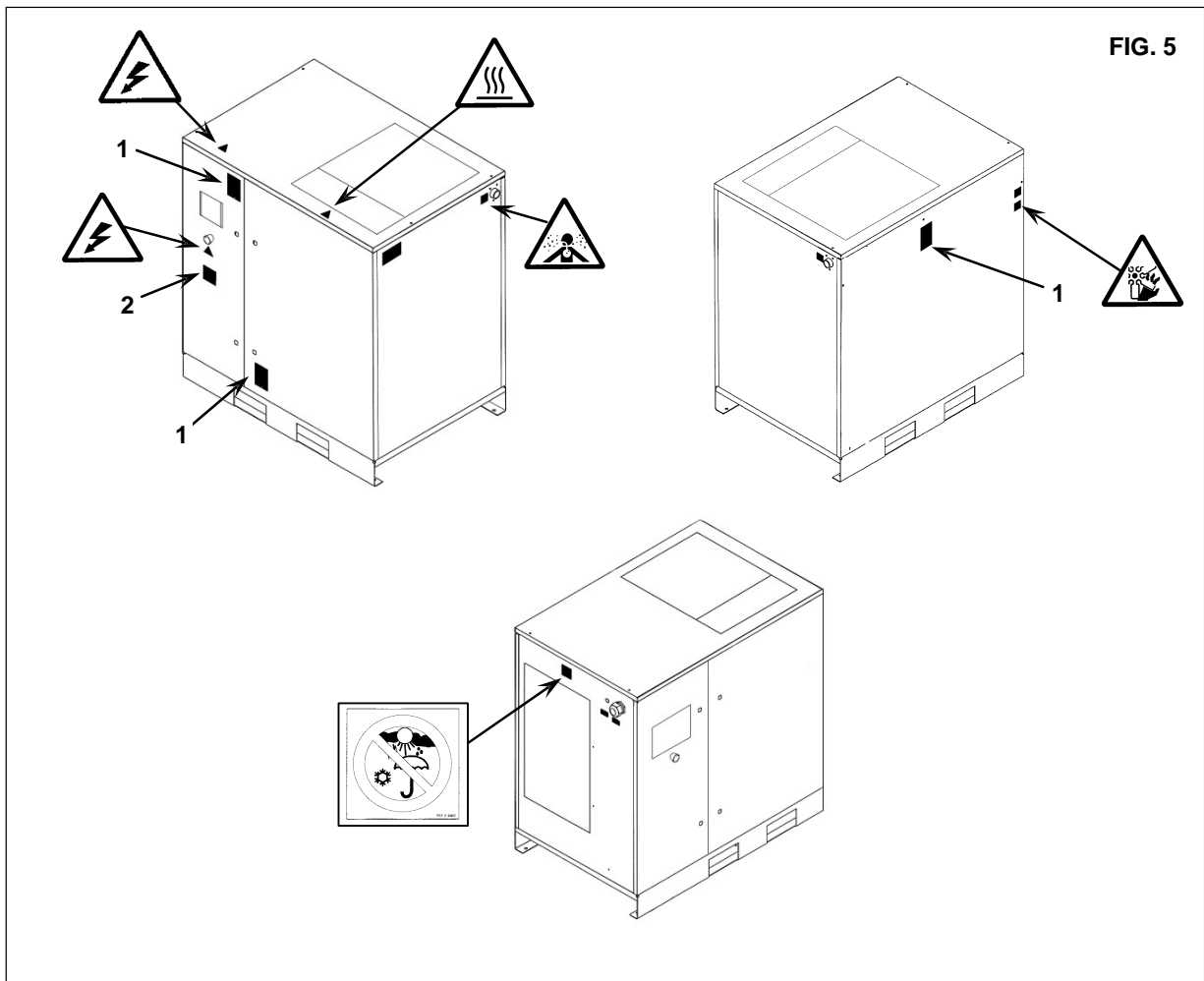

8.2 POSITION OF THE DANGER PLATES FOR DRYER UNIT

The plates fitted on the compressor unit are part of the machine; they have been applied for safety purposes and must not be removed or spoiled for any reason.

1) Dangers plate Cod. 1079990109

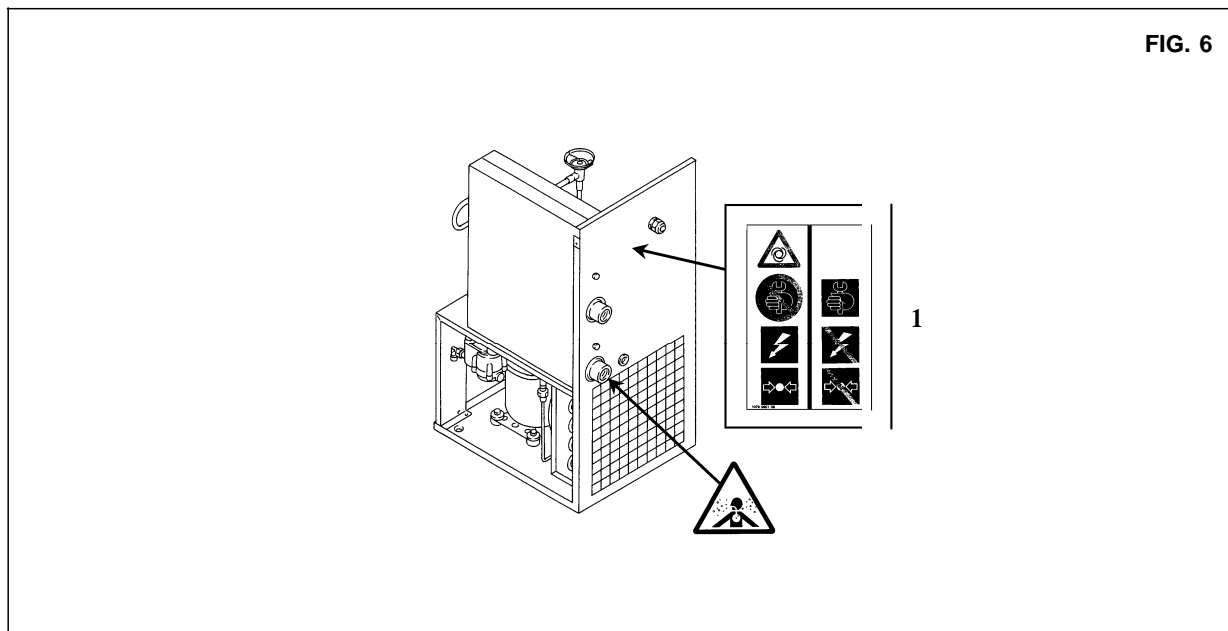

8.3 POSITION OF THE DATA PLATE FOR COMPRESSOR UNIT

1) Identification plate

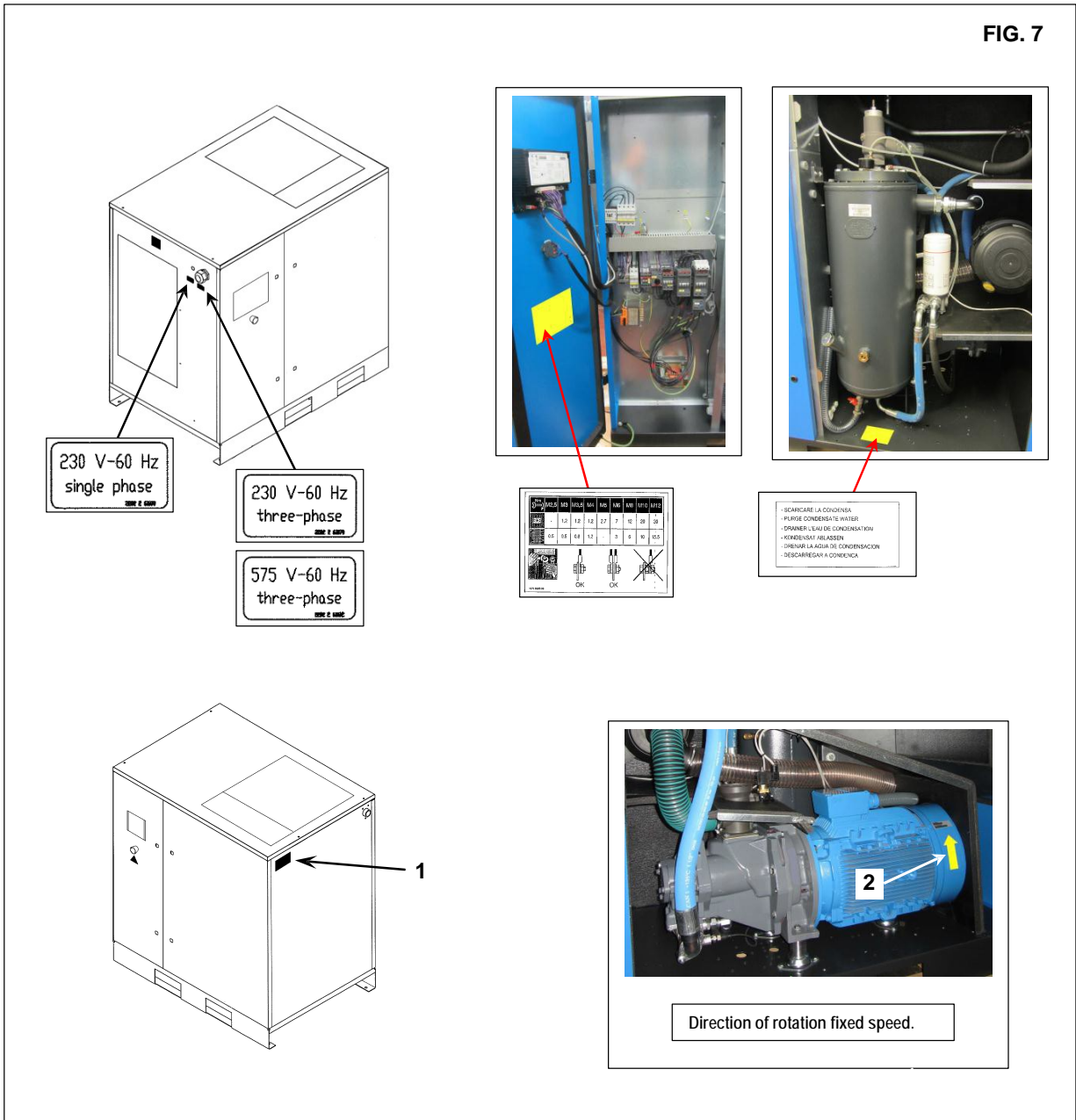

8.4 POSITION OF THE DATA PLATE FOR DRYER

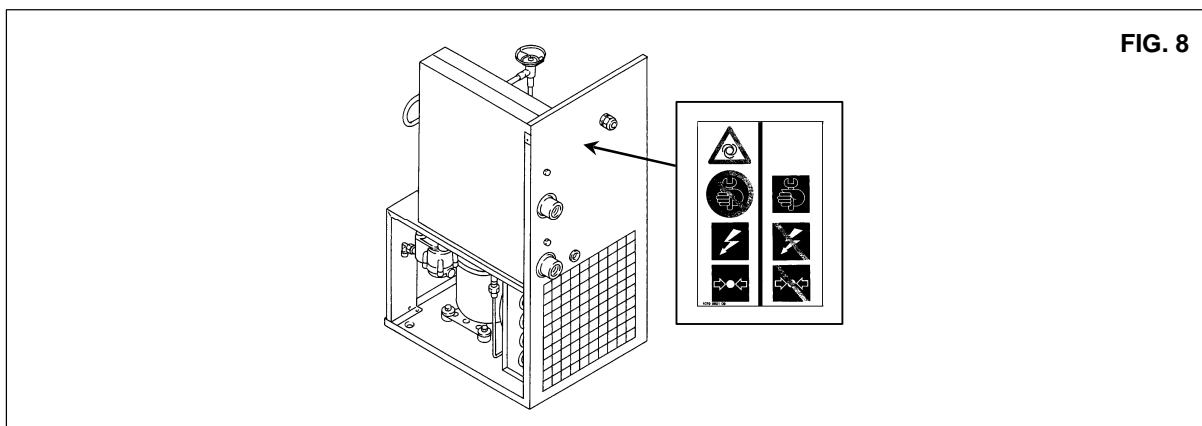

9.0 COMPRESSOR ROOM

9.1 FLOOR

The floor must be even and of industrial type; the total weight of the machine is shown in the Chap. 13.0 Remember the total weight of the machine when positioning it.

9.2 VENTILATION

When the machine is operating, the room temperature must not be higher than 46 °C (114,8 °F) or lower than 2 °C (35,6 °F). The volume of the room must be about 60 m³ The room must be provided with 2 openings for ventilation with a surface area of about 0,5 m² each. The first opening must be in a high position to evacuate the hot air, the second opening must be low to allow the intake of external air for ventilation. If the environment is dusty it is advisable to extract fit a filtering panel on this opening.

9.3 EXAMPLES OF VENTILATION OF THE COMPRESSOR ROOM

ATTENTION: Removable pipe to allow cleaning of the radiator.

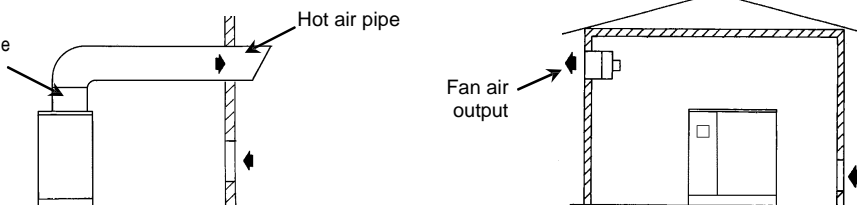

10.0 TRANSPORT AND HANDLING

The machine must be transported as shown in the following figures.

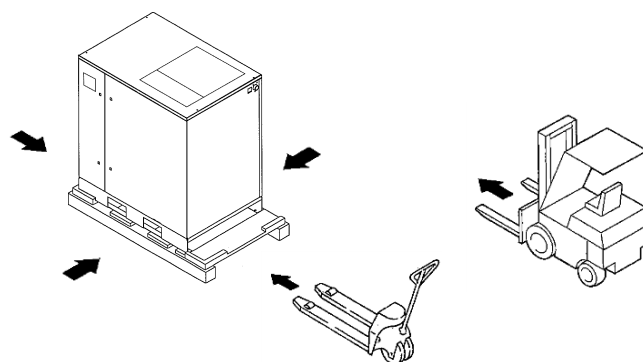

11.0 UNPACKING

After removing the packing, ensure that the machine is unbroken and that there are no visibly damaged parts. If you are in doubt, do not use the machine but contact the manufacturer or to your dealer. The packing material (plastic bags) must not be left within the reach of children or abandoned in the environment, as they are a potential source of danger and pollution. Dispose of these materials in the approved collection centres.

12.0 INSTALLATION

12.1 POSITIONING

After unpacking the equipment and preparing the compressor room, put the machine into position, checking the following items:

- ensure that there is sufficient space around the machine to allow maintenance (see Fig. 11).

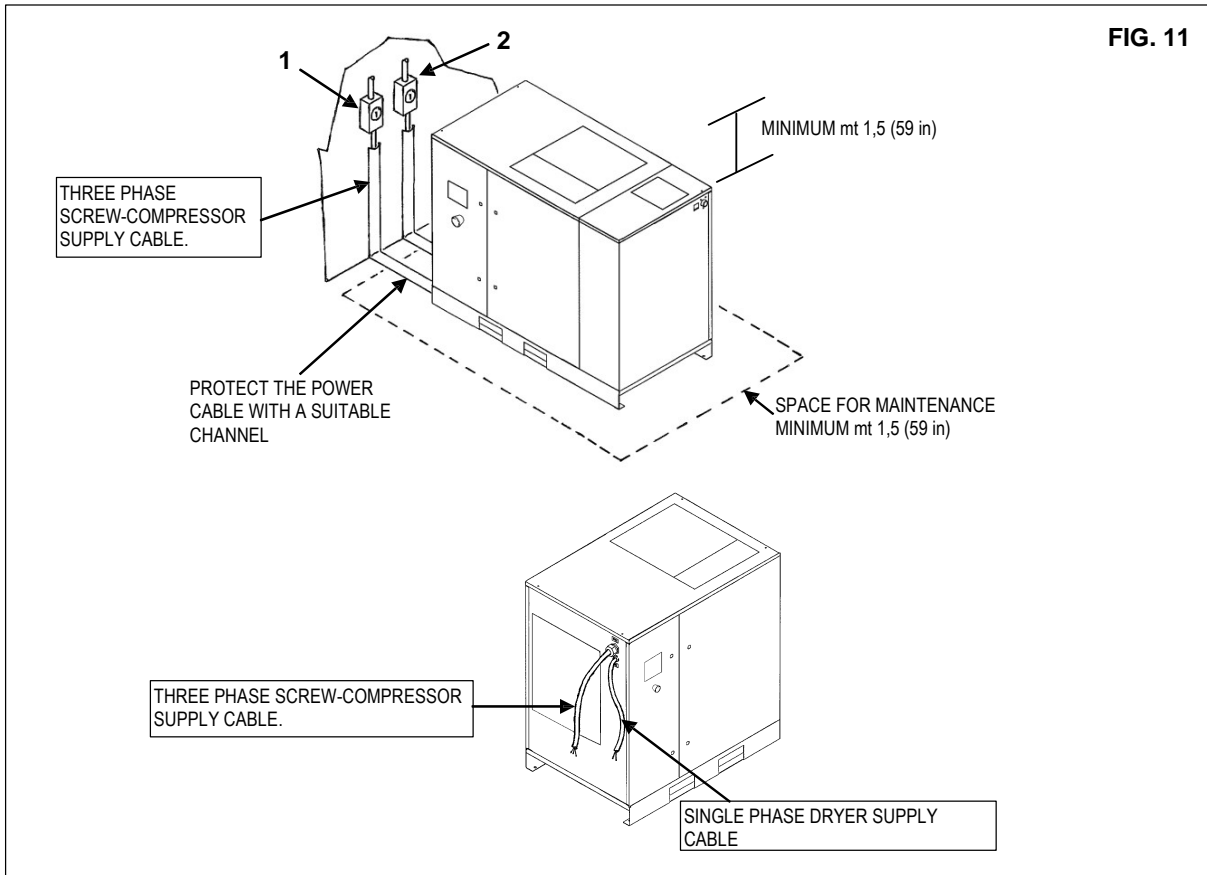

ENSURE THAT THE OPERATOR CAN SEE THE WHOLE MACHINE FROM THE CONTROL PANEL AND CHECK THE PRESENCE OF ANY UNAUTHORIZED PERSONS IN THE VICINITY OF THE MACHINE.

12.2 ELECTRICAL CONNECTION

- Check that the supply voltage is the same as the value indicated on the machine data plate.
- Check the condition of the line cables and ensure that there is an efficient earth lead.
- Ensure that there is a manual or automatic cut-out device upstream the machine and overcurrent protections (as described in service diagram) a differential device (see Ref. 1 for compressor Ref. 2 for dryer) wiring diagram.
- Connect the machine power cables with the greatest care, according to the standards in force. These cables must be as indicated on the machine wiring diagram.
- Connect the cables to the charging clamps on the electric panel and make sure they are properly tightened. After the first 50 working hours, check that the screws on the electric terminals are tight.



ONLY PROFESSIONALLY SKILLED PERSONNEL MAY HAVE ACCESS TO THE ELECTRIC PANEL. SWITCH OFF THE POWER BEFORE OPENING THE DOOR OF THE ELECTRIC PANEL. COMPLIANCE WITH THE REGULATIONS IN FORCE CONCERNING ELECTRIC PLANTS IS FUNDAMENTAL FOR OPERATOR SAFETY AND FOR THE PROTECTION OF THE MACHINE.

CABLES, PLUGS AND ALL OTHER TYPE OF ELECTRIC MATERIAL USED FOR THE CONNECTION MUST BE SUITABLE FOR THE USE AND COMPLYING WITH THE REQUIREMENTS STATED BY THE REGULATIONS IN FORCE.



The standard voltage configuration for the compressor is mentioned on the data plate of the machine.

NEVER OPERATE THE COMPRESSOR ON A VOLTAGE OTHER DIFFERENT THAN SHOWN ON THE ELECTRIC CABINET. For tri-voltage machine follow the instructions in the electrical diagram (inside cubicle) to convert the operating voltage of the compressor for either 208V or 230V or 460V

12.3 CONNECTION TO THE COMPRESSED AIR NETWORK

Isolation (ball) valve Ref. 1 between the machine and the compressed air network so that the compressor may be isolated during maintenance operations (see figure 12) .



PIPES, FITTINGS AND CONNECTIONS USED FOR THE CONNECTION OF THE ELECTROCOMPRESSOR TO THE COMPRESSED AIR NETWORK MUST BE SUITABLE TO THE USE ACCORDING TO THE INSTRUCTIONS OF THE REGULATIONS IN FORCE IN THE COUNTRY OF USE.

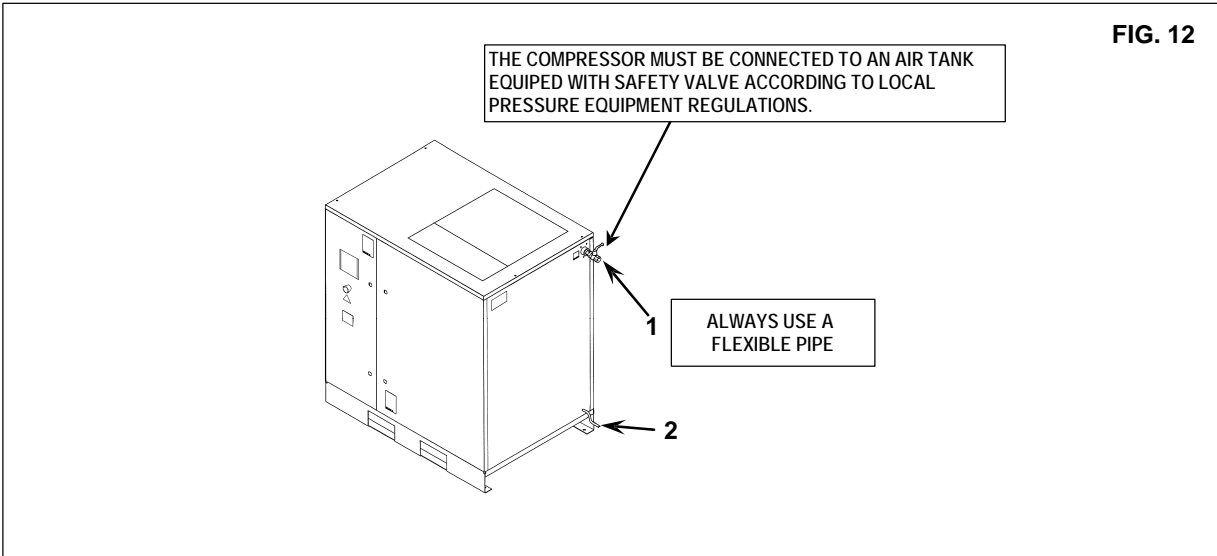

The automatic condensate drain Ref. 2 Fig. 12, are led outside the machine with a flexible pipe that may be inspected. Drainage must comply with the local regulations in force.



THE MANUFACTURER CANNOT ACCEPT LIABILITY, FOR ANY DAMAGE AND OR FAILURE CAUSED BY FAILURE TO COMPLY WITH THESE INSTRUCTIONS.

12.4 STARTING UP

See part B of this manual, Chapter 20.0

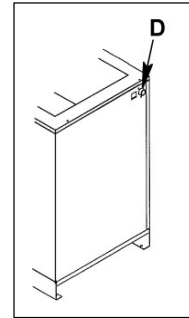
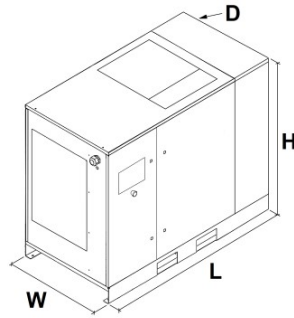
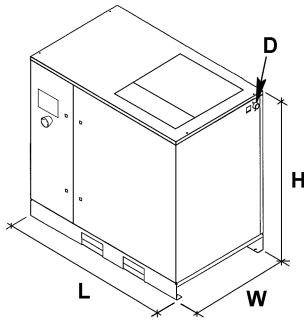

13.0 DIMENSIONS AND TECHNICAL DATA



	Dimensions mm (in)			Air connection
	L	W	H	D
HP 40-50 - kW 30-37	1526 (60)	830 (32,6)	1555 (61,2)	1"1/4
	<i>Weight kg. (lb)</i>			
HP 40 - kW 30	555 (1223,5)			
HP 50 - kW 37	618 (1362,4)			

	Dimensions mm (in)			Air connection
	L	W	H	D
HP 40-50 kW 30-37	2022 (79,6)	830 (32,6)	1555 (61,2)	1"1/4
	<i>Weight kg. (lb) (with dryer)</i>			
HP 40 - kW 30	670 (1477)			
HP 50 - kW 37	723 (1594)			

	HP 40 - kW 30				HP 50 - kW 37			
	7,5 (108)	8,5 (123)	10 (145)	13 (188)	7,5 (108)	8,5 (123)	10 (145)	13 (188)
Max. pressure bar (psi)								
Standard air capacity m3/h (cfm)	335 (197)	306 (180)	281 (165)	245 (144)	374 (220)	346 (203)	310 (182)	281 (165)
Noise product. dB(A)	68				69			
Oil operation timer setting °C (°F)	60 (140)				63 (145,4)			
Oil load lt. (gal)	22,5 (5,95)				22,5 (5,95)			

Type Dryer	Freon R 404A Kg. (lb)		 Nominal Power W (HP)		 Nominal Power W (HP)		Nominal Power W (HP)		 Bar (psi) MAX.
	50 Hz	60 Hz	50 Hz	60 Hz	50 Hz	60 Hz	50 Hz	60 Hz	
A 8+	See data plate dryer		996 (1,33)	1035 (1,38)	140 (0,18)	194 (0,26)	1136 (1,52)	1229 (1,64)	bar 13 (188)
A 10			1296 (1,73)	1455 (1,95)	150 (0,20)	190 (0,25)	1446 (1,93)	1645 (2,20)	bar 13 (188)

Reference conditions:

Ambient temperature 25 °C (77 °F)
 Inlet air temperature 35 °C (95 °F)
 Pressure 7 bar (101,5 psi)
 Dew point in pressure 3 °C (37,4 °F)

Limit conditions:

Max. ambient temperature 46°C (114,8 °F)
 Min. ambient temperature 4°C (39,2 °F)
 Max. working pressure 13 bar (188 psi)

14.0 MACHINE ILLUSTRATION

14.1 GENERAL LAY-OUT FOR DRYER

- 1 Air suction filter
- 2 Thermostatic valve
- 3 Oil filter
- 4 Air-oil cooler
- 6 Minimum pressure valve
- 7 Air-oil separator with oil separating filter
- 8 Top-up or oil filling cap
- 9 Control panel
- 10 Oil gauge
- 11 Oil discharge
- 12 Oil tank

- 13 Pressure gauge tank
- 14 Control card
- 15 Safety valve (*)
- 16 Condensate manual drainage
- 17 Electric motor
- 18 Screw compressor
- 19 Suction unit

* IT IS FORBIDDEN TO TAMPERE WITH THE PRESSURE SETTING OF THE SAFETY VALVE

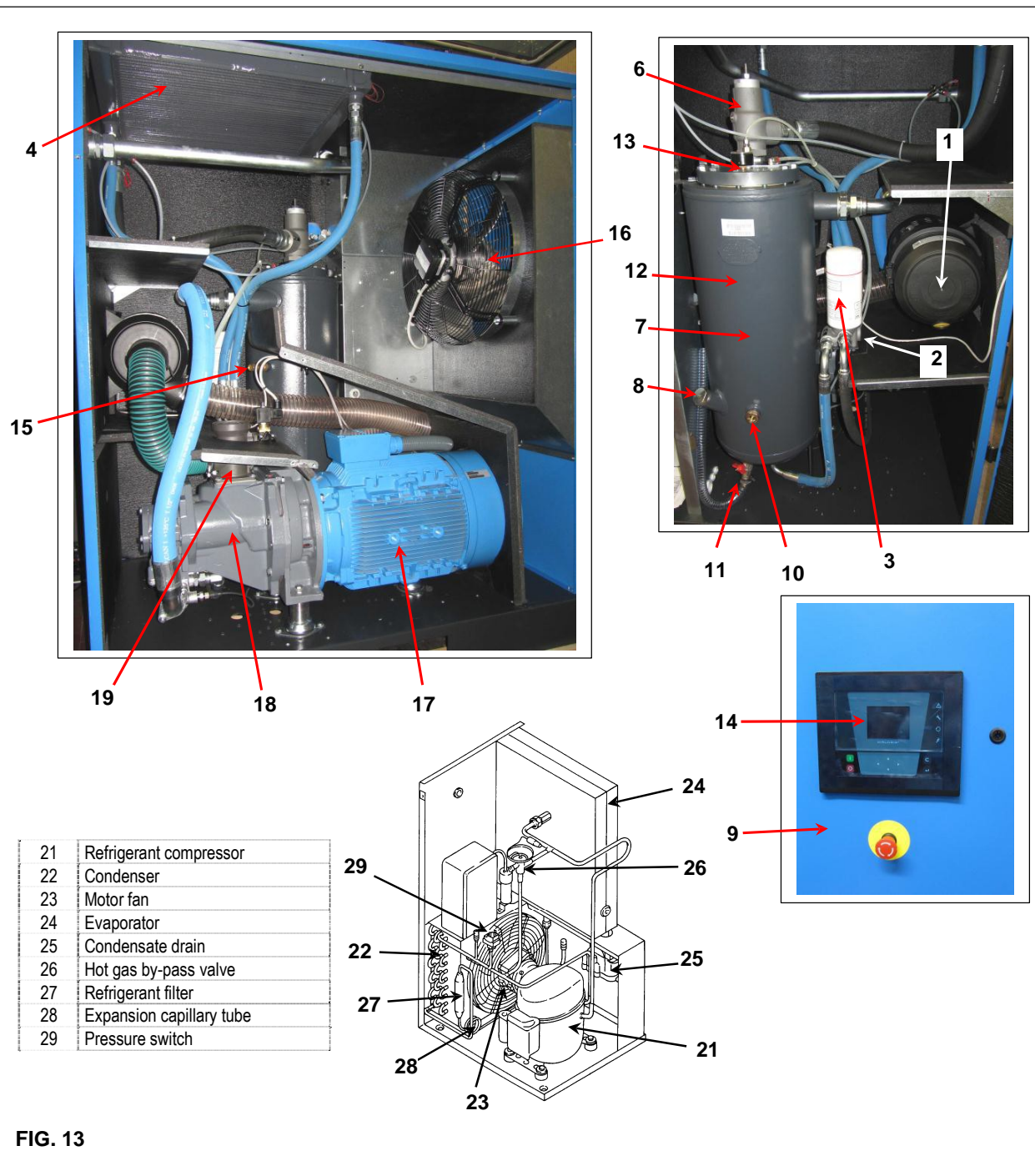

FIG. 13

ENGLISH

14.2 COMMAND AND CONTROL PANEL



BEFORE CARRYING OUT THE OPERATION TEST, READ CAREFULLY AND ACQUIRE A GOOD KNOWLEDGE OF THE COMMAND FUNCTIONS.

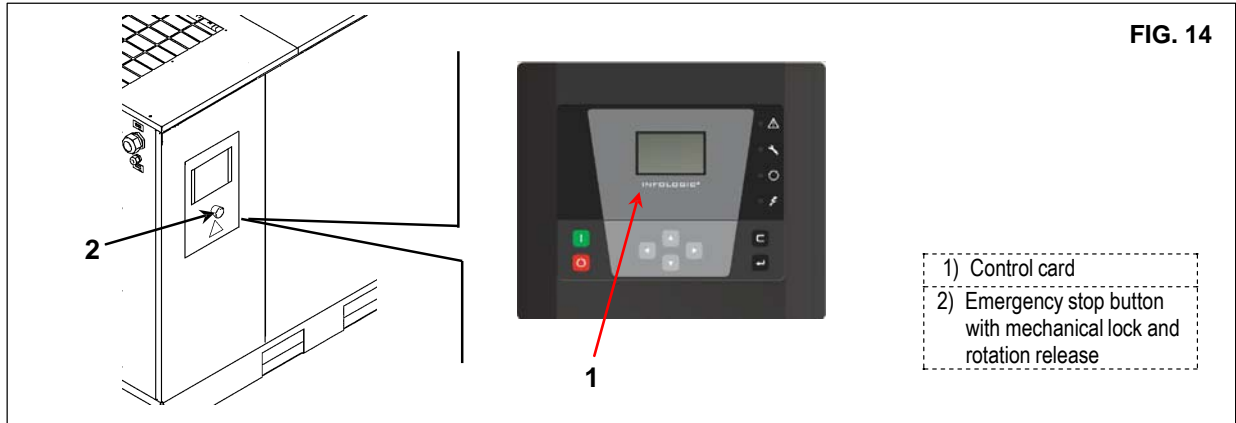

14.3 CONTROLLER (Standard controller for fixed speed compressors)

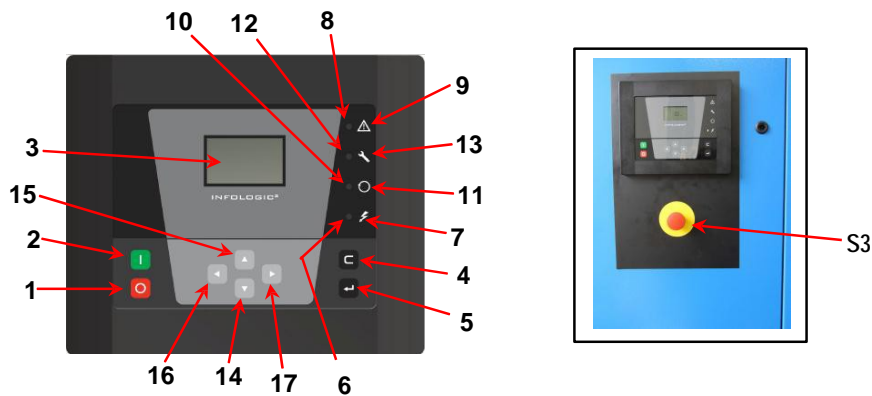

There is an electronic controller on the electric panel ; this controller includes the display of the functions as shown in figure 15.

1	Stop button (0)	10	Automatic operation led
2	Start button (I)	11	Automatic operation symbol
3	Display	12	Service warning led
4	Reset button	13	Service warning symbol
5	Enter key	14	Downward scroll key
6	Voltage on led	15	Upward scroll key
7	Voltage on symbol	16	Left scroll key
8	General alarm led	17	Right scroll key
9	General alarm symbol		



CAUTION: WAIT AT LEAST 20 SECONDS BEFORE STARTING THE MACHINE AFTER SWITCH OFF.

Introduction:

The controller performs the following functions:

- Compressor control
- Compressor protection
- Maintenance monitoring
- Automatic restart after supply interruption (optional).

Automatic control of the compressor

The controller maintains the outlet pressure within defined limits, commanding the load and unload operations of the compressor. Various parameters are considered, among them are: the unload pressure, the load pressure, the minimum stop time and the maximum number of motor starts.

Compressor protection

Shutdown

If outlet temperature of the element exceeds the programmed shut down level, the compressor will be stopped. This will be indicated on the display (3). The compressor will also stop if a motor overload occurs.

Before rectifying, consult the safety precautions.

Shut down warning:













A shut-down warning level is a programmable level below the shut-down level.

If one of the measured quantities exceeds the programmed shut-down warning level, an alarm message will be indicated to warn the operator before the shut-down level is reached.

Service warning:

If the service timer exceeds the programmed value, this will be indicated on the display (3) to warn the operator to specific service is due..

Tab. A

Ref.	Name	Description
S3	Emergency stop push button	Push the button to stop the compressor immediately in case of an emergency. After remedying the trouble, unlock the button by pulling it out and press the reset key (4).
1	 Stop button	Push the button to stop the compressor. The led (10) switches off. The compressor will stop after running in unloaded conditions.
2	 Start button	Push the button in order to start the compressor. The led (10) lights up, indicating that the controller is operating automatically the compressor.
3	Display	It shows the operating conditions of the compressor, the actual measured values and the programmed parameters.
4	 Reset button	Button to reset the service timer, a shut-down condition, or in order to return to a previous visualization on the display.
5	 Enter key	Key to select or to confirm a parameter, or to open a sub display.
6	Voltage on led	It indicates that the voltage is switched on
7	 Voltage on symbol	
8	General alarm led	It is lit in case of warning condition. It blinks in case of shut-down or emergency stop condition.
9	 General alarm symbol	
10	Automatic operation led	It indicates that the controller is operating the compressor automatically. The compressor is loaded, unloaded, stopped and restarted depending on the air demand and on the limitations programmed in the controller. The led is lit in during the automatic operations. It blinks when the unit is remotely controlled.
11	 Automatic operation symbol	
12	Service warning led	Illuminates if service is required.
13	 Service warning symbol	
14	 Downward scroll key	Key to scroll downward through the screens or to decrease a parameter value.
15	 Upward scroll key	Key to scroll upwards through the screens or to increase a parameter value.
16	 Left scroll key	Key to scroll left through the screens.
17	 Right scroll key	Key to scroll right through the screens.

ENGLISH













Display

The display (3) shows :

- The compressor status by means of pictographs.
- The air outlet pressure.
- The actual temperature of the compressor element outlet.
- The actual dew-point temperature in case of compressor equipped with dryer..

The display also shows all measured and programmed parameters.

Pictographs used on the screen (Tab. B)

Ref.	Pictographs	Description
1)	 81636D	Compressor on status load.
2)	 81534D	Compressor status unload.
3)	 81633D	Motor stopped.
4)	 81632D	When the compressor is stopped, the icon stands still. When the compressor is running, the icon is rotating.
5)	 81643D	Element outlet temperature.
6)	 81106D	Dew-point (dryer equipped version).
7)	 81542D	Motor overload or phase sequence incorrect or outlet element overtemperature detected by temperature switch
8)	 81540D	Emergency stop activated.
9)	 81541D	Pictograph: service.
10)	 81536D	Remote start / stop
11)	 81537D	LAN control or network setting.
12)	 81638D	Automatic restart after voltage failure is active
13)	 81539D	Timer

Main screen

When the voltage is switched on, the main screen is shown automatically, indicating the operation status of the compressor and the outlet temperature.

example:



The display is showing that the compressor is running loaded (when the horizontal arrow is blinking) and the outlet pressure is 6.8bar. Consult the service dept. if <test> appears on the display.

Shut down warning

A shut-down warning will appear in the event of:

- Too high temperature at the compressor element outlet.
- Too high dew-point temperature for dryer equipped units.

Compressor element outlet temperature

If the temperature of the compressor element exceeds the shut down warning level (105°C / 221°F), the alarm led (8) will light up and the related pictograph will appear blinking.

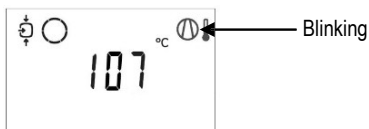

The screen shows that the temperature at the compressor element outlet is 107°C (224,6 °F).

Using the keys (14) and (15), it is possible to scroll through other screens to check the actual status of other parameters.

Stop the compressor using the button (1) and wait until the compressor stops.

Isolate the compressor from its power supply line of the compressor.

WARNING:  The unit must be disconnected from the power supply net!
Inspect the compressor and rectify.
The message warning will disappear as soon as the fault is no longer present.

Dew-point temperature

For compressors with integrated dryer:

If the dew point temperature exceeds the warning level (not programmable), the alarm led (8) will light up and the related pictograph will appear blinking.

Main screen with warning dew point temperature



Press the arrow key (14) until the actual dew point appears:



The screen shows that the actual dew-point temperature is 22°C (71,6 °F).

Using the keys (14) and (15), it is possible to scroll through other screens to check the actual status of other parameters.

Stop the compressor using the button (1) and wait until the compressor has stopped.

Isolate the compressor from its power supply line of the compressor.

WARNING:  The unit must be disconnected from the power supply net!
Inspect the unit and remedy.
The message warning will disappear as soon as the fault is no longer present.

ENGLISH

SHUT DOWN

The compressor will be shut-down in the following cases:

- The temperature at the outlet of the compressor element exceeds the shut-down level
- Error of the outlet pressure sensor
- Overload of the drive motor

Compressor element outlet temperature

If the outlet temperature of the compressor element exceeds the shut-down level (110°C / 230°F), the compressor will be shut-down, the alarm led (8) will blink, the automatic operation led (10) will switch off.

The following type of screen will appear.



Press the arrow key (14) until the actual compressor element temperature appears:



The screen shows that the temperature at the outlet of the compressor element is 122°C (251,6 °F).
Isolate the compressor from its power supply line of the compressor.

WARNING:  The unit must be disconnected from the power supply net!
Inspect the unit and rectify.

After rectifying and when the shut-down condition has disappeared, switch on the voltage and restart the compressor.

Motor overload

In case of motor overload, the compressor will be shut-down, the alarm led (8) will blink, the automatic operation led (10) will switch off and the following type of screen will appear:



Take care that the shut-down “Overload motor” appears in case of main motor overload or incorrect phase sequence (detected by phase sequence relay) or overtemperature detected by temperature switch.
Isolate the compressor from its power supply line of the compressor.

WARNING:  The unit must be disconnected from the power supply net!
Inspect the unit and remedy.

After rectifying and when the shut-down condition has disappeared, switch on the voltage and restart the compressor.

Service warning

A service warning will appear when the service timer has reached the programmed time interval.

The alarm led (12) will light up.

Press the arrow key (14) to reach the screen <d.06> with the service symbol.

Push the button (5) and the actual reading of the service timer will appear in <hrs> (or in <x1000hrs> if the service timer value is higher than 9999).



The screen shows that the reading of the service timer is 4002h.

Using the keys (14) or (15), scroll to the screen <d.01> and the running hours symbol will be shown.

Press the key (5) and the actual running hours will appear in <hrs> (or in <x1000hrs> if the value is higher than 9999).



Stop the unit.

Isolate the compressor from its power supply line of the compressor.

WARNING:  The unit must be disconnected from the power supply net!
Carry out the service actions. See the preventive maintenance schedule section.

THIS SHOULD ONLY BE CARRIED OUT BY AUTHORISED SERVICE PERSONNEL USING GENUINE SPARES - FAILURE TO COMPLY COULD VOID ANY WARRANTY.

Visualization of the time since last maintenance

Starting from the main screen:



Press the scroll key (14) until the screen <d.06> appears, then press enter key (5):



This screen shows the unit used is <hrs> (or <x1000 hrs>) and the value 1191: the compressor has run 1191 h since the previous service.

Resetting the service timer

After servicing, see section Service warning, the timer has to be reset:

Scroll to register screen <d.06> and press enter key (5).

The reading (e.g. 4000) will appear.

Press the enter key (5). If a password is set, enter the password.

The icon will flash (indicating that resetting is possible).

Press the enter key (5) to reset the timer to <0.000> or press reset key (4) to cancel the operation.

Scrolling through all screens

Scroll buttons (14) can be used to scroll through all screens. The screens are divided into register screens, measured data screens, digital input screens (numbered as <d.in>, <d.1>, ...), parameter screens (numbered as <P.1>, <P.2>, ...), protections screens (numbered as <Pr.2>, ...) and test screens (numbered as <t.1>, ...).

During scrolling, the numbers of the screens appear consecutively. For most screens, the unit of measurement and the related pictograph are shown together with the screen number.



Example

The screen shows the screen number <d.1>, the unit used <hrs> and the related symbol for running hours. Press Enter key (5) to call up the actual running hours.

Overview of the screens

Digital input screens	Designation	Related topic
<d.in>	Digital input status	
<d.1>	Running hours (hrs orx 1000 hrs)	
<d.2>	Motor starts (x1 orx 1000)	
<d.3>	Module hours (hrs orx 1000 hrs)	
<d.4>	Loading hours (hrs or x1 000 hrs)	
<d.5>	Load relay (x1 or x 1000)	
<d.6>	Service timer reading (hrs or x 1000 hrs)	
<d.7>	Actual program version	

Parameter screens	Designation	Related topic
<P.1>	Selection between local, remote or LAN control	
<P.2>	Setting a node ID for LAN control and the channels for Mk 4 and Mk 5	
<P.3>	Settings for IP, gateway and Subnet mask	
<P.4>	Pressure band settings	
<P.5>	Setting a pressure band selection	
<P.6>	Modifying a service timer	
<P.7>	Setting of unit for temperature	
<P.8>	Setting of unit for pressure	
<P.9>	Selection for function: Automatic restart after voltage failure	
<P.10>		
<P.11>	Setting of load delay time	
<P.12>	Setting of minimum stop time	
<P.13>	Setting a password	
<P.14>	Remote pressure sensing	

Parameter screens	Designation	Related topic
<Pr.2>	Protections screens	

Test screens	Designation	Related topic
<t.1>	Display test	
<t.2>	Safety valve test	

Menu flow

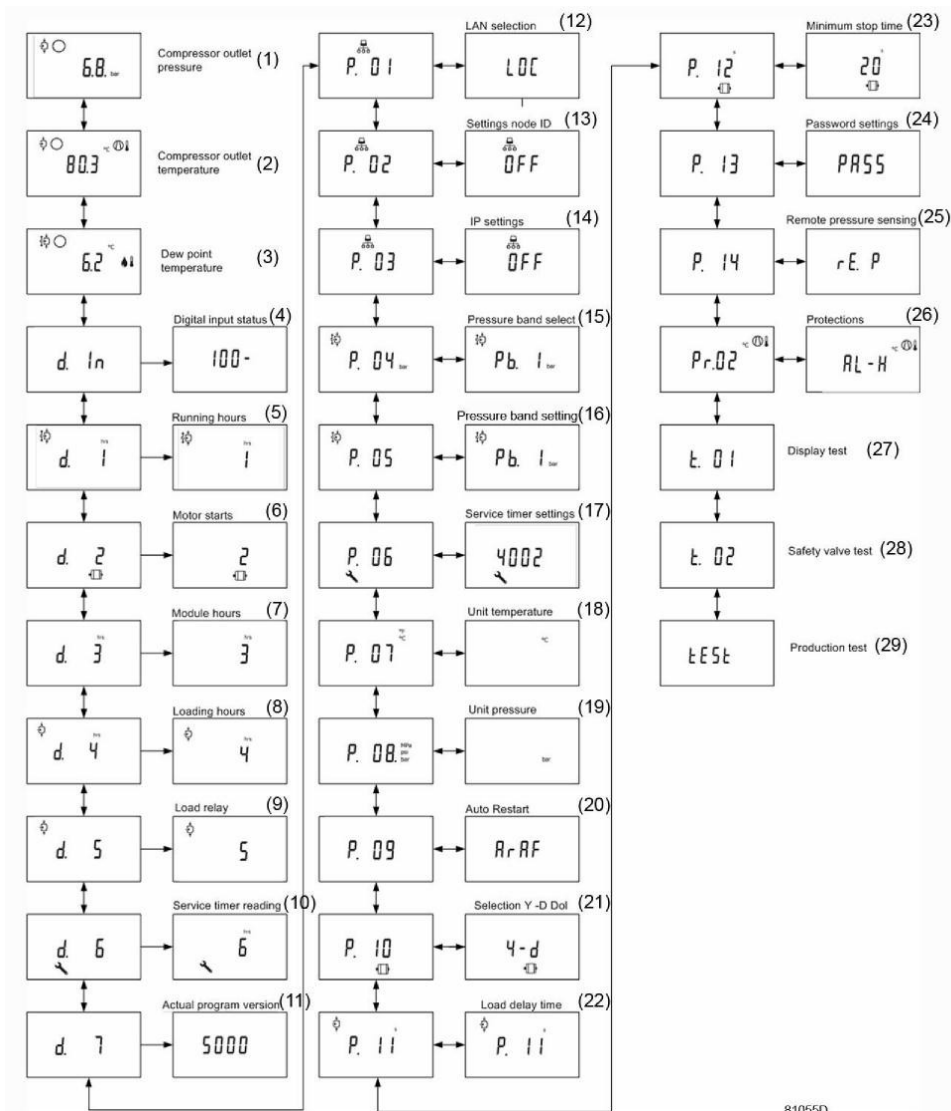

81055D

Simplified menu flow

Ref.	Description	Ref.	Description
(1)	Compressor outlet pressure	(16)	Pressure band setting
(2)	Compressor outlet temperature	(17)	Service timer settings
(3)	Dewpoint temperature	(18)	Temperature unit
(4)	Digital input status	(19)	Unit pressure
(5)	Running hours	(20)	Auto restart
(6)	Motor starts	(21)	
(7)	Module hours	(22)	Load delay time
(8)	Loading hours	(23)	Minimum stop time
(9)	Load relay	(24)	Password settings
(10)	Service timer reading	(25)	Remote pressure sensing
(11)	Actual program version	(26)	Protections
(12)	LAN selection	(27)	Display test
(13)	Settings node ID	(28)	Safety valve test
(14)	IP settings	(29)	
(15)	Pressure band selection		

14.5 Graphic controller (Option), for fixed speed compressor.

Introduction

The electronic controller has following functions:

- Controlling the compressor
- Protecting the compressor
- Monitoring components subject to service
- Automatic restart after voltage failure (option)



Automatic control of the compressor

The controller maintains the net pressure between programmable limits by automatically loading and unloading the compressor in case of fixed speed machines.

A number of programmable settings, e.g. the unloading and loading pressures, the minimum stop time and the maximum number of motor starts are taken into account.

The controller stops the compressor whenever possible to reduce the power consumption and restarts it automatically when the net pressure decreases. If the expected unloading period is too short, the compressor is kept running to prevent too short stand-still periods.

Protecting the compressor

Shut-down

The compressor will be stopped and it will be indicated on the display in the following events:

- compressor element outlet temperature bigger than the programmed shut-down level detected by temperature sensor
- compressor element outlet temperature bigger than the programmed shut-down level detected by temperature switch
- overload of the drive motor

In chapter "Shut-down visualization" it's explained how it appears on the display, how to recognize which is the shut-down and how to solve it.

Shut-down warning

A shut-down warning level is a programmable level below the shut-down level. If one of the measurements exceeds the programmed shut-down warning level, this will also be indicated to warn the operator before the shut-down level is reached. The shut-down warning appears in case of:

- Too high temperature at the compressor element outlet
- Too high or too low dew-point temperature for dryer equipped units

In chapter "Shut-down warning visualization" it's explained how it appears on the display, how to recognize which is the warning and how to solve it.

Service warning

If the service timer exceeds a programmed value, this will be indicated on the display to warn the operator to carry out some service actions.

Automatic restart after voltage failure

The controller has a built-in function to automatically restart the compressor when the voltage is restored after voltage failure.

The function is not active and to activate it please contact the customer center.



Provided the controller is in the automatic operation mode, the compressor will automatically restart when the supply voltage to the module is restored.

Control panel

FIG. 16

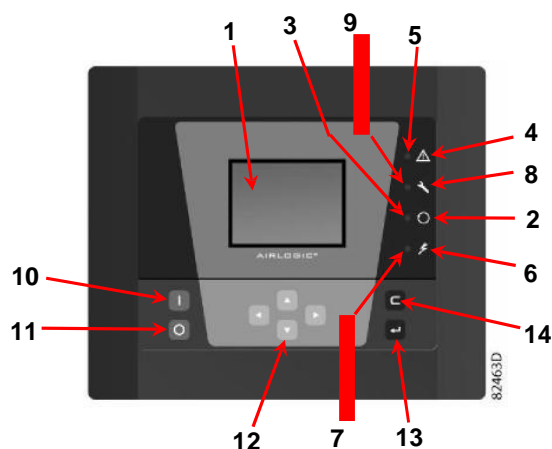



















Function keys of the controller

Reference	Designation	Function
1	Display	Shows icons and operating conditions.
2	Automatic operation symbol	
3	LED, Automatic operation	Indicates that the regulator is automatically controlling the compressor: the compressor is loaded, unloaded, stopped and restarted depending on the air consumption and the limitations programmed in the regulator.
4	Warning symbol	
5	LED, Warning	Is lit if a warning condition exists.
6	Voltage symbol	
7	LED, Voltage on	Indicates that the voltage is switched on.
8	Service symbol	
9	LED, Service	Is lit when service is needed.
10	Start button	This button starts the compressor. Automatic operation LED (3) lights up. The Elektronikon is operative.
11	Stop button	This button is used to stop the compressor. Automatic operation LED (3) goes out.
12	Scroll buttons	Use these buttons to scroll through the menu .
13	Enter button	Use this button to confirm the last action.
14	Escape button	Use this button to go to previous screen or to end the current action.





ENGLISH

Icons used









Status icons

Name	Icon	Description
Stopped / Running	 57786F	When the compressor is stopped, the icon stands still. When the compressor is running, the icon is rotating.
Compressor status	 57787F	Motor stopped
	 57788F	Running unloaded
	 57789F	Running loaded
Machine control mode	 57790F Or  59161F	Local start / stop
	 57791F	Remote start / stop
	 57792F	Network control
Automatic restart after voltage failure	 57793F	Automatic restart after voltage failure is active
Week timer	 57794F	Week timer is active
Active protection functions	 57795F	Emergency stop
	 57796F	Shutdown
	 57797F	Warning
Service	 57798F	Service required
Main screen display	 82196F	Value lines display icon
	 82196F	Chart display icon
General icons	 81105D	No communication / network problem
	 82418D	Not valid















Input icons

Icon	Description	Icon	Description
 57800F	Pressure	 57801F	Digital input
 57800F	Temperature	 57802F	Special protection

System icons

Icon	Description	Icon	Description
 57803F	Compressor element (LP, HP, ...)	 57809F	Motor
 57804F	Dryer	 57810F	Failure expansion module
 57805F	Fan	 81105D	Network problem
 57806F	Frequency converter	 57812F	General alarm

Menu icons

Icon	Description	Icon	Description
 57813F	Inputs	 57815F	Event history (saved data)
 57814F	Outputs	 57819F	Access key / User password
 57812F	Protections (Warnings, shutdowns)	 57819F	Network
 57815F	Counters	 57820F	Setpoint
 82641D	Test	 57857F	Information
 57817F	Regulation (Settings)	 57794F	Week Timer
 57796F	Service	 82633D	General

Navigation arrows

 57821F	Up	 57822F	Down
--	----	--	------

Main screen

Function

The Main screen is the screen that is shown automatically when the voltage is switched on and one of the keys is pushed. It is switched off automatically after a few minutes when no keys are pushed.

Typically, 5 different main screen views can be chosen:

- Two value lines
- Four value lines
- Chart (High resolution)
- Chart (Medium resolution)
- Chart (Low resolution)

Two and four value lines screens

This type of Main screen shows the value of 2 or 4 parameters (see section Inputs menu).

ENGLISH



Typical Main screen (2 value lines), fixed speed compressors

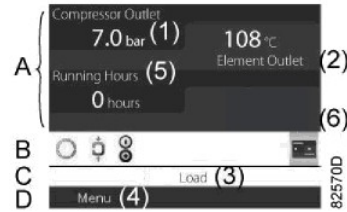

Typical Main screen (4 value lines), fixed speed compressors

Text on figures

(1)	Compressor Outlet
(2)	Element outlet
(3)	Load, ... (text varies upon the compressors actual condition)
(4)	Menu
(5)	Running hours
(6)	Dryer dew point temperature (Only if dryer is present)

Section A shows information regarding the compressor operation (e.g. the outlet pressure or the temperature at the compressor outlet).

Section B shows Status icons. Following icon types are shown in this field:

- Fixed icons

These icons are always shown in the main screen and cannot be selected by the cursor (e.g. Compressor stopped or running, Compressor status (running, running unloaded or motor stopped)).

- Optional icons

These icons are only shown if their corresponding function is activated (e.g. week timer, automatic restart after voltage failure , etc.)

- Pop up icons

These icons pop up if an abnormal condition occurs (warnings, shutdowns, service,...)

To call up more information about the icons shown, select the icon concerned using the scroll keys and press the enter key.

Section C is called the Status bar. This bar shows the text that corresponds to the selected icon.

Section D shows the Action buttons. These buttons are used:

- To call up or program settings
- To reset a motor overload, service message or emergency stop
- To have access to all data collected by the regulator
- The function of the buttons depends on the displayed menu. The most common functions are "Menu" (To go to the menu), "Modify" (To modify programmable settings), "Reset" (To reset a timer or message)

To activate an action button, highlight the button by using the Scroll keys and press the Enter key. To go back to the previous menu, press the Escape key.

Chart views

Instead of viewing values, it is also possible to view a graph of one of the input signals (see section Inputs menu) in function of the time.

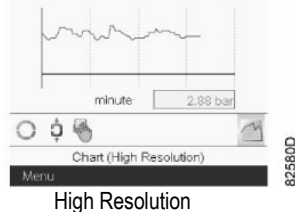

High Resolution

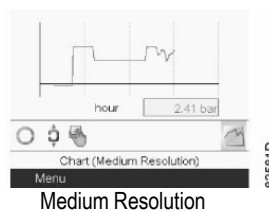

Medium Resolution

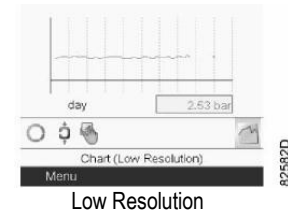

Low Resolution

When Chart (High Resolution) is selected, the chart shows the variation of the selected input (in this case the pressure) per minute. Also the instantaneous value is displayed. The screen shows the last 4 minutes.

The switch button (icon) for selecting other screens is changed into a small Chart and is highlighted (active).

When the Chart (Medium Resolution) is selected, the chart shows the variation of the selected input per hour. The screen shows the last 4 hours.

When the Chart (Low Resolution) is selected, the chart shows the variation of the selected input per day. The screen shows the evolution over the last 10 days.

Selection of a main screen view

To change between the different screen layouts, select the far right icon in the control icons line (see value lines display icon or chart display icon in section Used icons) and press the Enter key. A screen similar to the one below opens:

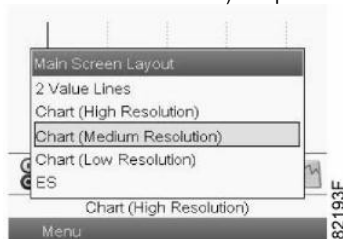

Select the layout required and press the Enter key. See also section Inputs menu.

Calling up menus

Description

When the voltage is switched on, the main screen is shown automatically (see section Main screen):



To go to the Menu screen, highlight the Menu button (4), using the Scroll keys. Press the Enter key to select the menu. Following screen appears:

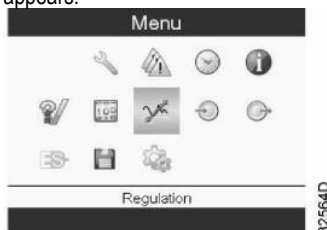

The screen shows a number of icons. Each icon indicates a menu item. By default, the Pressure Settings (Regulation) icon is selected. The status bar shows the name of the menu that corresponds with the selected icon. Use the Scroll keys to select an icon. Press the Escape key to return to the Main screen.

Shut-down warning visualization

In case of shut-down warning a yellow triangle (1) pops up in the lower side of the display as in the picture below in the left side:

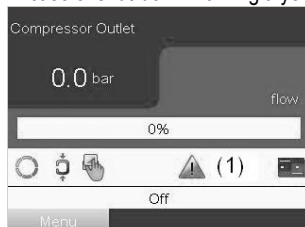

To check which is the warning, highlight the yellow triangle, using the Scroll keys. Press the Enter key and it will appear the Protections menu as in picture above in the right side. Press Enter key and then in the display will appear the list of the Protection that are active on the controller. Use Scroll key to check all the protections and the one who is causing the warning will be highlighted as in picture below:

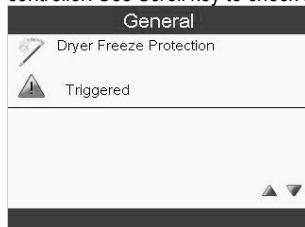

Stop the compressor pressing the button (11) in the Fig. 17A and wait until the compressor stops. Open the disconnect switch in the supply line of the compressor.

WARNING:  Before carrying out any maintenance the machine must be stopped, cut off the machine from the electrical mains and from the compressed air distribution circuit, check that the machine is not under pressure. Inspect the compressor and remedy.

ENGLISH

The message warning will disappear as soon as the warning condition disappears.

Shut-down visualization

In case of shut-down red icon (1) pops up in the lower side of the display as in the picture below in the left side:

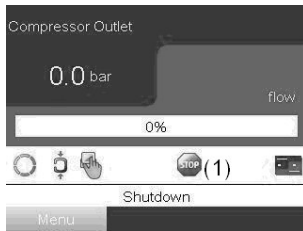

To check which is the shutdown, highlight the red icon, using the Scroll keys. Press the Enter key and it will appear the Protections menu as in picture above in the right side. Press Enter key and then in the display will appear the list of the Protection that are active on the controller. Use Scroll key to check all the protections and the one who is causing the shutdown will be highlighted as in picture below:

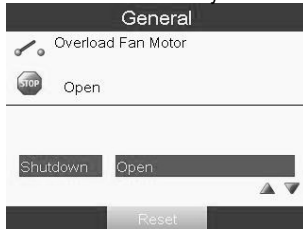

Take care that the shut-down “Overload motor” appears in case of main motor overload or incorrect phase sequence (detected by phase sequence relay) or overtemperature detected by temperature switch. Open the disconnect switch in the supply line of the compressor.

WARNING:  Before carrying out any maintenance the machine must be stopped, cut off the machine from the electrical mains and from the compressed air distribution circuit, check that the machine is not under pressure. Inspect the compressor and remedy. After remedying and when the shut-down condition has disappear, switch on the voltage and restart the compressor.

Inputs menu

Function: to display the actual value of the measured data (analog inputs) and the status of the digital inputs (e.g. emergency stop contact, motor overload relay, etc.) and to select the digital input to be shown on the chart in the main screen.

Procedure

Starting from the main screen (see Main screen), move the cursor to the action button Menu and press the Enter key.

Using the Scroll keys, move the cursor to the Inputs icon, as shown in the following screen:

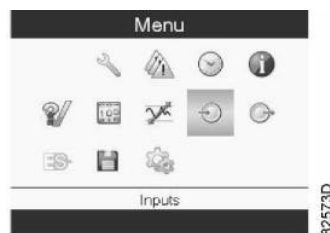

Press the Enter key. A screen similar to the one below appears:



(1)	Inputs
(2)	Compressor outlet
(3)	Element outlet
(4)	Ambient air
(5)	Emergency stop

The screen shows a list of all inputs with their corresponding icons and readings.

If an input is in warning or shutdown, the original icon is replaced by the warning or shutdown icon respectively (i.e. the Stop icon and the Warning icon in the screen shown above).

A small chart icon, shown below an item in the list means this input signal is shown on the chart at the main screen. Any analog input can be selected.

Outputs menu

Function: to call up information regarding the actual status of some outputs.

Procedure: starting from the Main screen (see Main screen), move the cursor to the action button Menu and press the Enter key, move the cursor to the Outputs icon (see below).

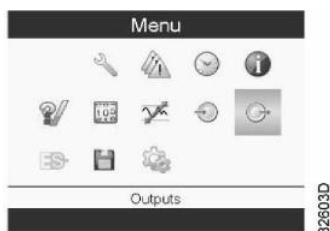

Press the Enter key. A screen similar to the one below appears:



(1)	Outputs
(2)	Fan motor contact
(3)	Blow-off contact
(4)	General shutdown
(5)	Automatic operation

Outputs screen (typical)

The screen shows a list of all outputs with their status.

Counters

Function: to call up the running hours, the loaded hours, the number of motor starts, the number of hours that the regulator has been powered and the number of load cycles.

Procedure: starting from the Main screen (see Main screen), move the cursor to the action button Menu and press the Enter key. Using the Scroll keys, move the cursor to the Counters icon (see below)

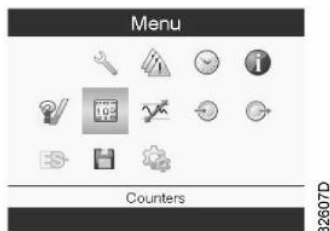

Press the Enter key. A screen similar to the one below appears:



(1)	Counters
(2)	Running hours
(3)	Loaded hours
(4)	Motor starts
(5)	Load relay

The screen shows a list of all counters with their actual readings.

ENGLISH

Control mode selection

Function: to select the control mode, i.e. whether the compressor is in local control, remote control or controlled via a local area network (LAN).

Procedure: starting from the main screen, make sure the action button Menu (1) is selected:



Next, use the scroll buttons to go to the Status icons (see Main screen) and select the Regulation icon (2). When the icon is active, this icon is highlighted with a grey background colour.

Press the enter button:

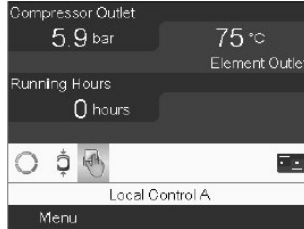

There are 3 possibilities:

Local control

Remote control

LAN (network) control

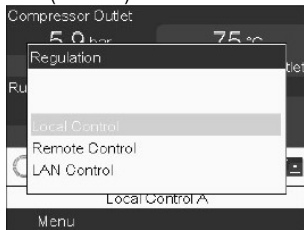

After selecting the required regulation mode, press the enter button on the controller to confirm your selection. The new setting is now visible on the main screen. See section Used icons for the meaning of the icons.

Service menu

Function: to reset the service plans which are carried out, to check when the next service plans are to be carried out, to find out which service plans were carried out in the past and to modify the programmed service intervals.

Procedure: starting from the Main screen (see Main screen), move the cursor to the action button Menu and press the Enter key.

Using the Scroll keys, move the cursor to the Service icon (see below).



Press the Enter key. Following screen appears:

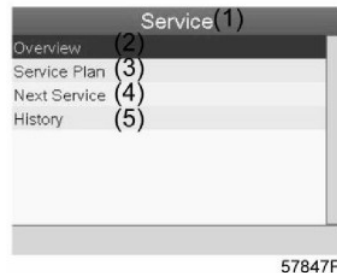

(1)	Service
(2)	Overview
(3)	Service plan
(4)	Next service
(5)	History

Scroll through the items to select the desired item and press the Enter key to see the details as explained below.

Overview

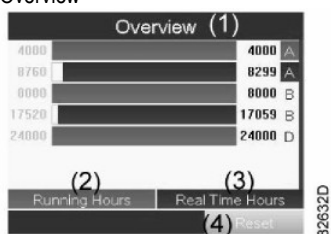

(1)	Overview
(2)	Running Hours
(3)	Real Time hours
(4)	Reset

Example for service level (A): the figures at the left are the programmed service intervals. For Service interval A, the programmed number of running hours is 4000 hours (upper row, green) and the programmed number of real time hours is 8760 hours, which corresponds to one year (second row, blue). This means that the controller will launch a service warning when either 4000 running hours or 8760 real hours are reached, whichever comes first. Note that the real time hours counter keeps counting, also when the controller is not powered. The figures at the end of the bars are the number of hours to go till the next service intervention. In the example above, the compressor was just started up, which means it still has 4000 running hours or 8299 hours to go before the next Service intervention.

Service plans

A number of service operations are grouped (called Level A, Level B, etc...). Each level stands for a number of service actions to be carried out at the time intervals programmed in the controller.

When a service plan interval is reached, a message will appear on the screen.

After carrying out the service actions related to the indicated levels, the timers must be reset. From the Service menu above, select Service plan (3) and press Enter. Following screen appears:

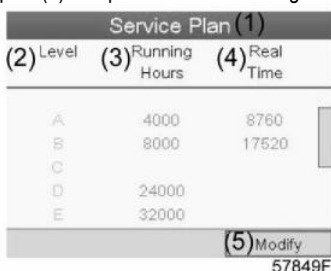

(1)	Service plan
(2)	Level
(3)	Running hours
(4)	Real time hours
(5)	Modify

In the example above, the A Service level is programmed at 4000 running hours, of which 0 hours have passed. History
The History screen shows a list of all service actions done in the past, sorted by date. The date at the top is the most recent service action. To see the details of a completed service action (e.g. Service level, Running hours or Real time hours), use the Scroll keys to select the desired action and press the Enter key.

Regulation menu

Function: on fixed speed compressors, the operator can program two different pressure bands. This menu is also used to select the active pressure band.

Procedure: starting from the Main screen (see Main screen), move the cursor to the action button Menu and press the Enter key.

Using the Scroll keys, move the cursor to the Setpoint icon (see below).



Press the Enter key. Following screen appears:



(1)	Regulation
(2)	Unloading pressure 1
(3)	Loading pressure 1
(4)	Unloading pressure 2
(5)	Loading pressure 2
(6)	Modify

The screen shows the actual unloading and loading pressure settings for both pressure bands. To modify the settings, move the cursor to the action button Modify and press the Enter key. Following screen appears:

ENGLISH



The first line of the screen is highlighted. Use the Scroll keys to highlight the setting to be modified and press the Enter key. Following screen appears:



The upper and lower limit of the setting is shown in grey, the actual setting is shown in black. Use the ↑ or ↓ key of the Scroll keys to modify the settings as required and press the Enter key to accept.

If necessary, change the other settings as required in the same way as described above.

Event history menu

Function: to call up the last shut-down and last emergency stop data.

Procedure: starting from the Main screen (see Main screen), move the cursor to the action button Menu and press the Enter key.

Using the Scroll keys, move the cursor to the Event History icon (see below).



Press the Enter key. The list of last shut-down and emergency stop cases is shown.



Example of Event History screen

Scroll through the items to select the desired shut-down or emergency stop event.

Press the Enter key to find the date, time and other data reflecting the status of the compressor when that shut-down or emergency stop occurred.

Modifying general setting

Function: to display and modify a number of general settings.

Procedure: starting from the Main screen (see Main screen), move the cursor to the action button Menu and press the Enter key.

Using the Scroll keys, move the cursor to the Settings icon (see below).

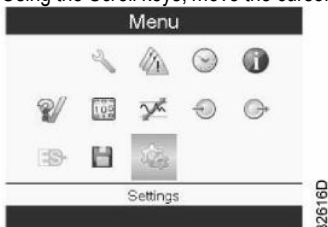

Press the Enter key. A second menu screen appears:

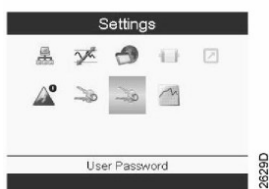

This submenu screen shows again a number of icons. By default, the User Password icon is selected. Also the status bar shows the name of the menu that corresponds with the selected icon.

General menu

Function: this menu covers a list of general settings:

- Language
- Time
- Date
- Date Format
- Units

Procedure: starting from the submenu screen (see Modifying general settings), using the Scroll keys, move the cursor to the General icon (see below).

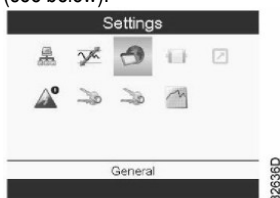

Press the Enter key. A screen similar to the one below appears:



(1)	General
(2)	Language in use
(3)	Time
(4)	Date
(5)	Date format
(6)	Modify

A screen similar to the one above is shown, a selection bar is covering the first item (Language). Use the ↓ key of the Scroll keys to select the setting to be modified and press the Enter key.

To modify, select the Modify button using the Scroll keys and press the Enter key.

A pop-up screen appears. Use the ↑ or ↓ key to select the required parameter and press the Enter key to confirm.

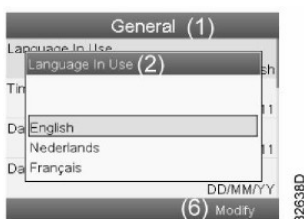

ENGLISH

Terminology

Term	Explanation
ARAVF	Automatic restart after voltage failure.
Power recovery time	Is the period within which the voltage must be restored to have an automatic restart. Is accessible if the automatic restart is activated. To activate the automatic restart function, consult your supplier.
Restart delay	This parameter allows to programme that not all compressors are restarted at the same time after a power failure (ARAVF active).
Compressor element outlet	The regulator does not accept inconsistent settings, e.g. if the warning level is programmed at 95 °C (203 °F), the minimum limit for the shut-down level changes to 96 °C (204 °F). The recommended difference between the warning level and shut-down level is 10 °C (18 °F).
Delay at shut- down signal	Is the time for which the signal must exist before the compressor is shut down. If it is required to program this setting to another value, consult your supplier.
Minimum stop time	Once the compressor has automatically stopped, it will remain stopped for the minimum stop time, whatever happens with the net air pressure. Consult your supplier if a setting lower than 20 seconds is required.
Unloading/ Loading pressure	The regulator does not accept illogical settings, e.g. if the unloading pressure is programmed at 7.0 bar(e) (101 psi(g)), the maximum limit for the loading pressure changes to 6.9 bar(e) (100 psi(g)). The recommended minimum pressure difference between loading and unloading is 0.6 bar (9 psi(g)).

15.0 ORDINARY MAINTENANCE TO BE DONE BY THE USER



BEFORE PERFORMING ANY MAINTENANCE IT IS MANDATORY TO STOP THE MACHINE AND DISCONNECT IT FROM THE POWER MAINS AND FROM THE COMPRESSED AIR DISTRIBUTION NETWORK.

The maintenance jobs described in this chapter may be carried out by the user.

The more complex maintenance jobs which require professionally skilled personnel are listed in the chapter on **GENERAL ROUTINE MAINTENANCE**. (See Chap. 21.0)

15.1 GENERAL INFORMATION

15.2 MAINTENANCE PROGRAMME

■ OPERATIONS THAT MAY BE CARRIED OUT BY THE USER

■ ■ OPERATIONS THAT REQUIRE SKILLED PERSONNEL; THESE OPERATIONS ARE ILLUSTRATED IN PART B OF THIS MANUAL.

These maintenance intervals are recommended for work environments that are not dusty and are well ventilated. For particularly dusty environments, double the frequency of controls.

Every Day (after use)	<ul style="list-style-type: none"> ■ Check automatic condensation drain (dryer)
Every 50 working hours	<ul style="list-style-type: none"> ■ Drain condensate from the oil tank ■ Check the oil level ■ Clean the filter of the automatic condensate drain (dryer)
Every 500 hours	<ul style="list-style-type: none"> ■ Replace oil filter (at first 500 hrs) ■ Tighten the screws fixing the electric cables (at first 500 hrs) ■ Clean the air inlet filter ■ Clean the condenser heat exchanger (unit with dryer) ■ Clean the inlet filtration panels
Every 2000 hours	<ul style="list-style-type: none"> ■ Replace the inlet air filter ■ ■ Replace the oil filter ■ ■ Retighten all power cable connections ■ ■ Safety temperature test ■ ■ Maintenance kit of the automatic condensate drain (dryer) ■ ■ Oil Fluid sample
Every 4000 hours	<ul style="list-style-type: none"> ■ ■ Clean the finned surface of the air-oil cooler ■ ■ Replace the oil separator filter
Every 8000 hours	<ul style="list-style-type: none"> ■ ■ Intake service kit ■ ■ Check status of oil return valve and oil pipes ■ ■ MPV Service kit ■ ■ Replace the oil *

* The compressor must be maintained with QuinSyn-Plus (8,000 hour maximum), QuinSyn-XP (12,000 hour maximum) or QuinSyn-F food grade (6,000 hour maximum). Maximum fluid change intervals are noted per fluid. Actual fluid change interval is to be determined by fluid sampling report, not to exceed maximum fluid change interval. **Fluid samples must be taken every 2,000 hours or as directed by the analysis report.** For light usage units, a fluid sample must be taken a minimum, of every six (6) months, beginning at start-up.

ENGLISH

15.3 DRAINING CONDENSATE FROM THE OIL TANK

If the compressor work cycle contemplates long pauses during which the machine cools down, a certain amount of condensate will gather in the oil tank. This happens, for example, when stopping overnight or at weekends.

The condensate must be drained off every 50 hours or every week. This operation may be performed only when the machine is cold, that is when it has been switched off for at least 8 hours.



BEFORE DRAINING THE CONDENSATE IT IS MANDATORY TO STOP THE MACHINE AND DISCONNECT IT FROM THE POWER MAINS.

Proceed as follows:

- Switch off the machine with pushbutton Ref. 1 Fig. 17: in this way the machine stops after idle time running.
- Turn on the differential supply switch, Ref. 3 (on the screw-compressor) and Ref. 3A (on the dryer if fitted) Fig. 17.

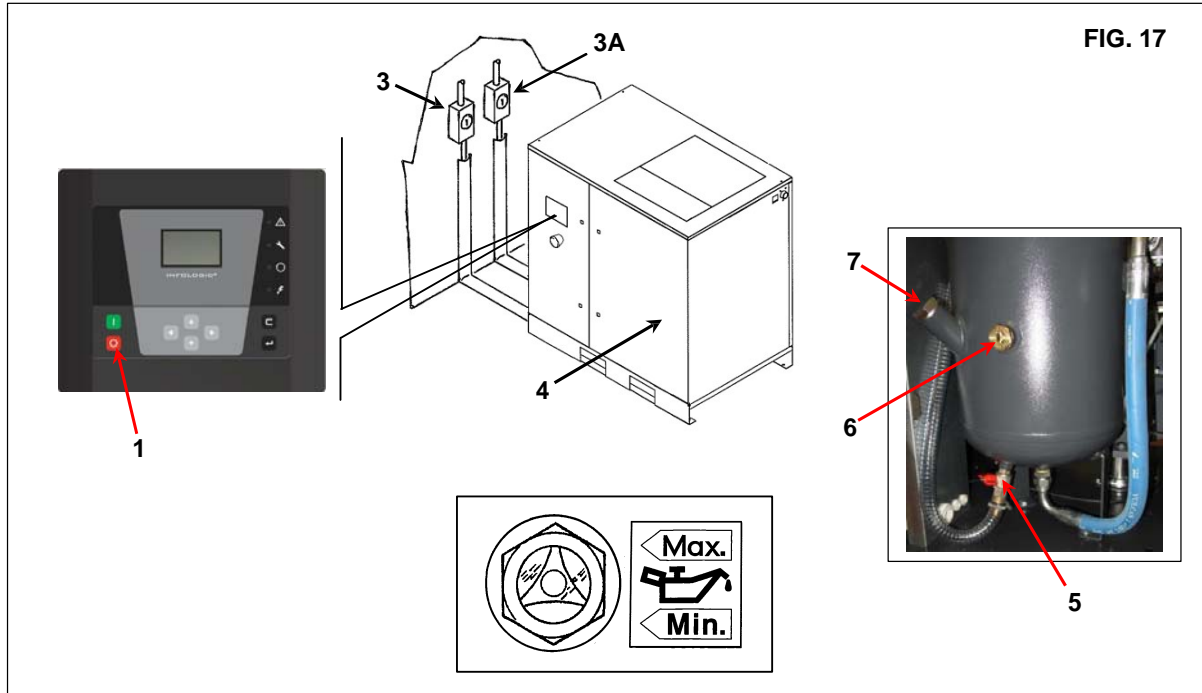

- Wait for the machine to cool down.
- Remove the panels Ref. 4 Fig. 17 with the key provided.
- SLOWLY turn on the tap Ref. 5 Fig. 17 and let the condensate flow out.
- When the first traces of oil appear, turn off the tap.



CONDENSATE MUST BE DISPOSED OF IN CONFORMITY WITH THE LOCAL REGULATIONS IN FORCE.

- Check the oil level on the indicator Ref. 6 Fig. 17.
- If the oil level is under the minimum, top up as described at point 15.4.

15.4 CHECK OIL LEVEL AND TOP UP

- Switch off the machine with push button Ref. 1 Fig. 17: in this way the machine will not stop instantly after idle time running.
- Turn on the differential supply switch, Ref. 3 (on the screw-compressor) and Ref. 3A (on the dryer if fitted) Fig. 17.
- Wait a few minutes for the oil level to settle foam in the collector to abate.
- Check the oil level on the indicator Ref. 6 Fig. 17
- If the oil level is under the minimum, top up.



USE OIL OF THE SAME TYPE AS THAT ALREADY IN THE MACHINE; DO NOT MIX DIFFERENT TYPES OF OIL.

BEFORE CARRYING OUT ANY OPERATION ON THE MACHINE, ENSURE THAT THE ELECTRIC POWER SUPPLY HAS BEEN DISCONNECTED.

- Open the front panel Ref. 4 Fig. 17 with the special key.
- Slowly open the oil plug Ref. 7 Fig. 17.
- Top up to maximum level Ref. 6 Fig. 17, with oil of the same type in the compressor.
- Turn off the cap of the oil tank Ref. 7 Fig. 17.
- Close the panel Ref. 4 Fig. 17.



BEFORE PERFORMING ANY MAINTENANCE IT IS MANDATORY TO STOP THE MACHINE AND DISCONNECT IT FROM THE POWER MAINS AND FROM THE COMPRESSED AIR DISTRIBUTION NETWORK.

15.5 CLEANING THE INLET PANEL FILTER

- Switch off the machine with pushbutton Ref. 1 Fig. 17: in this way the machine stops after idle time running.
- Turn on the main supply switch, Ref. 3 (on the screw-compressor) and Ref. 3A (on the dryer if fitted) Fig. 17.
- Remove the filters covers from cabinet door Ref. 1 Fig. 18.
- Clean the filters pads covers using compressed air or water. **Do not use solvents.**
- Once operation is complete, reassemble the filter covers Ref. 1 Fig. 18.

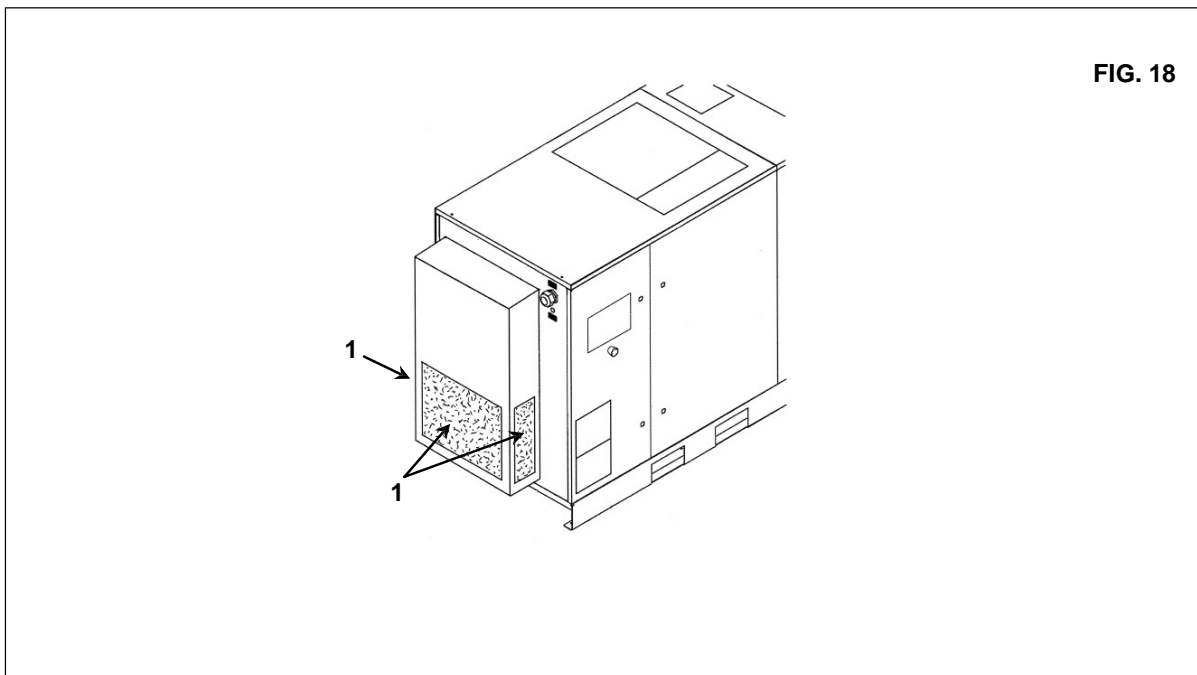



BEFORE PERFORMING ANY MAINTENANCE IT IS MANDATORY TO STOP THE MACHINE AND DISCONNECT IT FROM THE POWER MAINS AND FROM THE COMPRESSED AIR DISTRIBUTION NETWORK.

15.6 CLEANING THE AIR INLET FILTER OR REPLACING THE FILTER

- Switch off the machine with pushbutton Ref. 1 Fig. 17: in this way the compressor will not stop instantly.
- Turn on the differential supply switch, Ref. 3 (on the screw-compressor) and Ref. 3A (on the dryer if fitted) Fig. 17.



HOT PARTS INSIDE

- Remove the panel Ref. 2 Fig. 18.
- Remove the cover Ref. 7 Fig. 19.
- Remove the filter Ref. 8 Fig. 19.



AVOID DROPPING FOREIGN BODIES INTO THE INLET DUCT.

- Clean the filter with a jet of air, working from inside to outside, **DO NOT USE WATER OR SOLVENTS**. Alternatively, fit a new filter.
- Clean the disk on which the filter rests with a clean cloth.
- Fit the filter and the cover.
- If necessary, dispose of the old filter in conformity with the local regulations in force.
- Close the panel Ref. 2 Fig. 18.

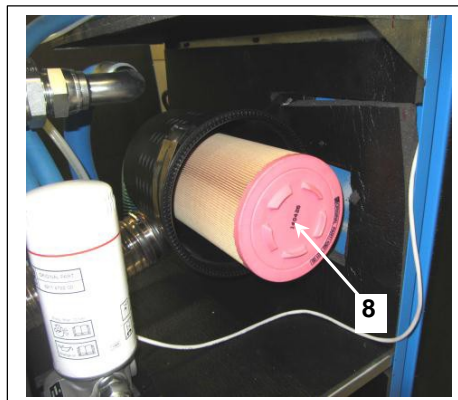
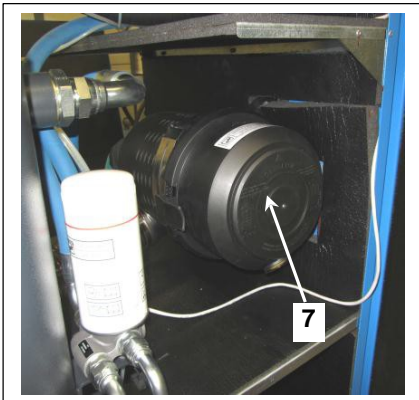

FIG. 19

15.7 CHECKING THE AUTOMATIC AND MANUAL CONDENSATE DRAIN (FOR DRYER)



BEFORE PERFORMING ANY MAINTENANCE IT IS MANDATORY TO STOP THE MACHINE AND DISCONNECT IT FROM THE POWER MAINS AND FROM THE COMPRESSED AIR DISTRIBUTION NETWORK.

The automatic condensation drain must be checked (Rif. 1 every 500 hours) Fig. 20.

Proceed as follows:

- Press the "TEST" button, Ref. 1 Fig. 20, for a few seconds to check if the condensation is correctly emptied from the drainage pipe

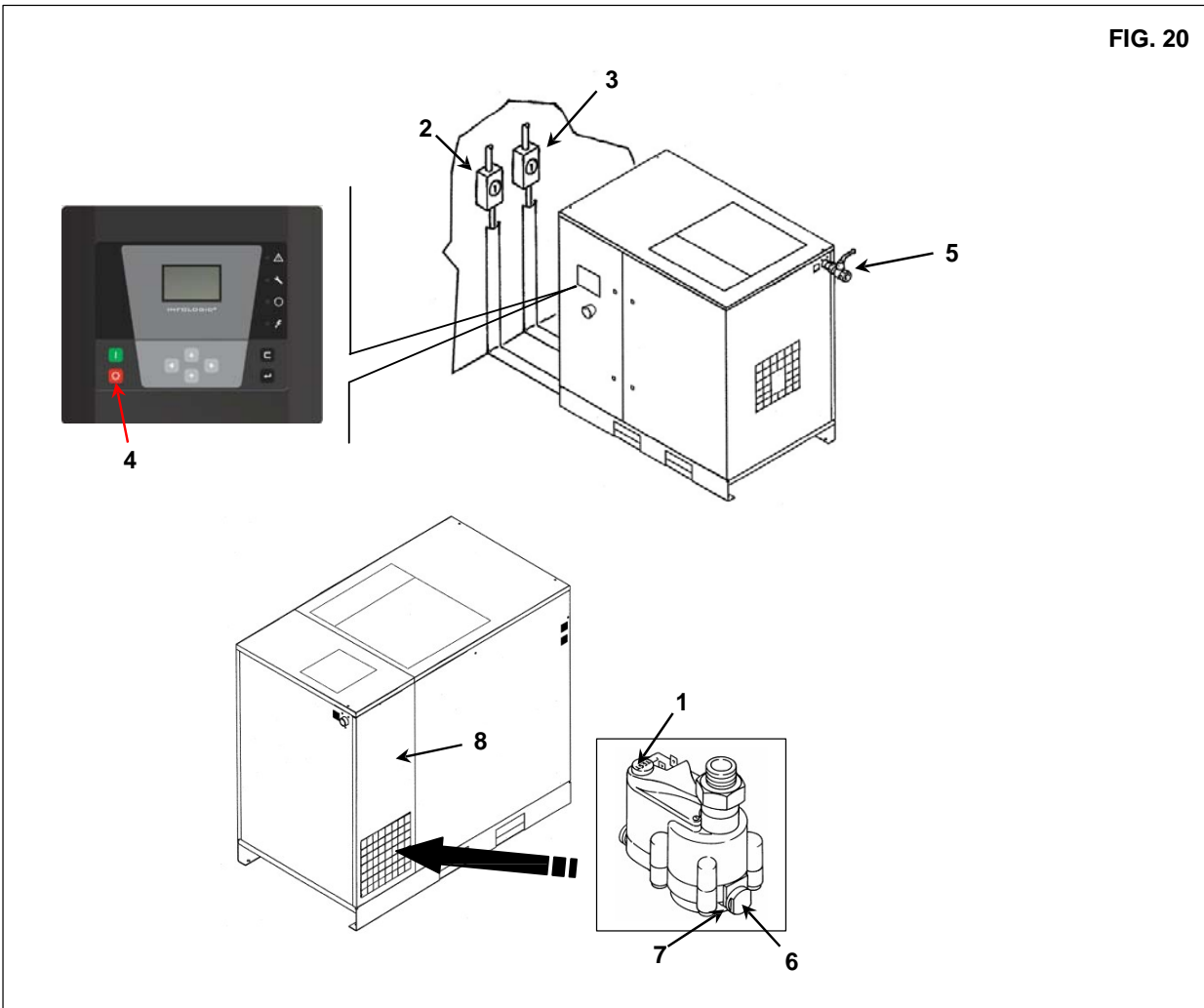

15.8 CLEAN THE DRAIN MESH (ONLY FOR UNITS EQUIPPED WITH REFRIGERANT DRYER)

Proceed as follows:

- Close the ball valve at machine at the air outlet Ref. 5 Ref. 20
- Depressurise the dryer by pressing the "TEST" button on drain (for about 10-20 seconds) Ref. 1 Fig.20
- Switch off the machine with push button Ref. 4 Fig. 20: in this way the machine stops after idle time running.
- Turn off the isolator switch, Ref. 2 (on the screw-compressor) and Ref. 3 (on the dryer if fitted) Fig. 20.
- Remove the panel Ref. 8 Fig. 20 (only for HP 40-50 / kW 30-37)
- Remove the threaded plug Ref. 6 Fig. 20
- Remove the filter Ref. 7 Fig. 20 (filter mesh)
- Clean the filter mesh using compressed air.
- Install the filter, fix the plug.
- Install the panel Ref. 8 Fig. 20 (only for HP 40-50 / kW 30-37)

ENGLISH

15.9 CLEANING CONDENSER HEAT EXCHANGER (ON THE DRYER IF FITTED)



BEFORE PERFORMING ANY MAINTENANCE IT IS MANDATORY TO STOP THE MACHINE AND DISCONNECT IT FROM THE POWER MAINS AND FROM THE COMPRESSED AIR DISTRIBUTION NETWORK.

The condenser must be cleaned every month.

Proceed as follows:

- Switch off the machine with push button Ref. 1 Fig. 21: in this way the compressor will not stop instantly.
- Switch off the main switch, Ref. 2 (on the screw-compressor) and Ref. 3 (on the dryer if fitted) Fig. 21.



HOT PARTS INSIDE THE DRYER

- Remove the filter panel Ref. 4 Fig. 21
- Clean the condenser fins with compressed air (See Fig A). DO NOT USE WATER OR SOLVENTS.
- Re-assemble the back panel Ref. 4 Fig. 21

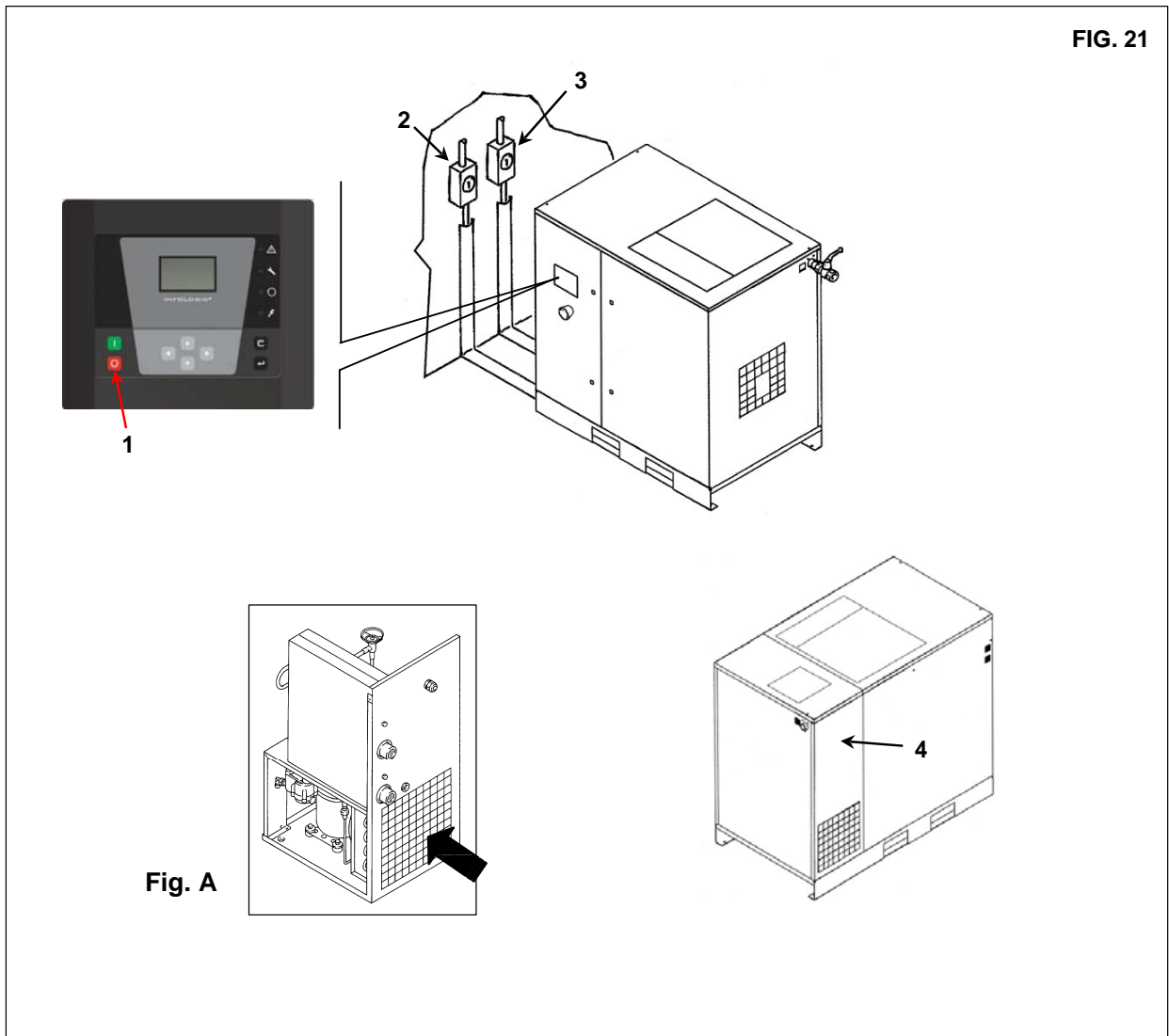

16.0 PERIODS OF INACTIVITY

If the machine remains inactive for a long period:

- Close the ball valve Ref. 1 Fig. 22.
- Remove the panel Ref. 8 Fig. 22 (only for HP 40-50 / kW 30-37)
- Depressurise the dryer by pressing the "TEST" condensate drain button (for about 10-20 seconds) Ref. 2 Fig.22
- Switch off the machine with press Ref. 3 Fig. 22: in this way the machine stops after idle time running.
- Switch off the main switch, Ref. 4 (on the screw-compressor) and Ref. 5 (on the dryer if fitted) Fig. 22.
- Assemble the panel Ref. 8 Fig. 22 (only for HP 40-50 / kW 30-37)

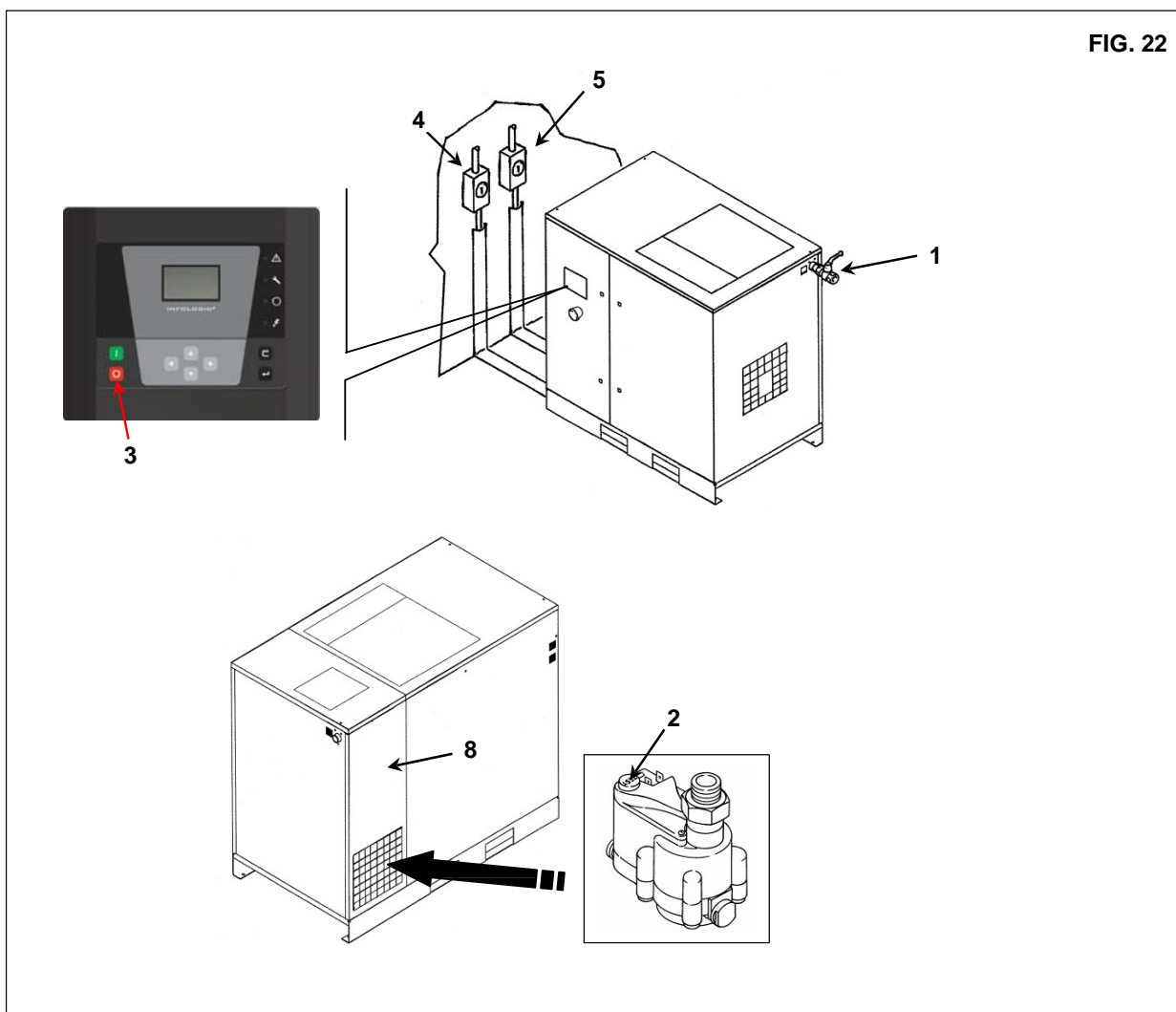

During periods of inactivity the unit needs to be protected against atmospheric agents, dust and humidity which could damage the motor and the electrical system.

To restart the machine after periods of inactivity, consult the manufacturer.

17.0 SCRAPPING THE UNIT

If the machine needs to be scrapped, it must be dismantled into parts of the same material, to be disposed of according to the local regulations in force.



ALWAYS RESPECT THE REGULATIONS IN FORCE FOR DISPOSING OF OLD OIL AND OTHER POLLUTING MATERIALS SUCH AS SOUND-PROOFING, INSULATING FOAM, ETC.

18.0 LIST OF SPARE PARTS FOR ROUTINE MAINTENANCE

Réf	DESCRIPTION	Q.ty	Code	HP 40 / kW 30				HP 50 / kW 37			
				7,5 bar (108 psi)	8,5 bar (123 psi)	10 bar (145 psi)	13 bar (188 psi)	7,5 bar (108 psi)	8,5 bar (123 psi)	10 bar (145 psi)	13 bar (188 psi)
2	Oil filter	1	6211 4722 50	■	■	■	■	■	■	■	■
3	Suction air filter	1	1092 1001 90	■	■	■	■	■	■	■	■
4	Separator cartridge	1	6221 3744 50	■	■	■	■	■	■	■	■
5	Gaskets separator cartridge	2	2204 1197 00	■	■	■	■	■	■	■	■
6	Filtering panel	1	2204 1203 03	■	■	■	■	■	■	■	■
7	Filtering panel	2	2204 1203 02	■	■	■	■	■	■	■	■
8	Filtering panel	1	2204 1203 01	■	■	■	■	■	■	■	■

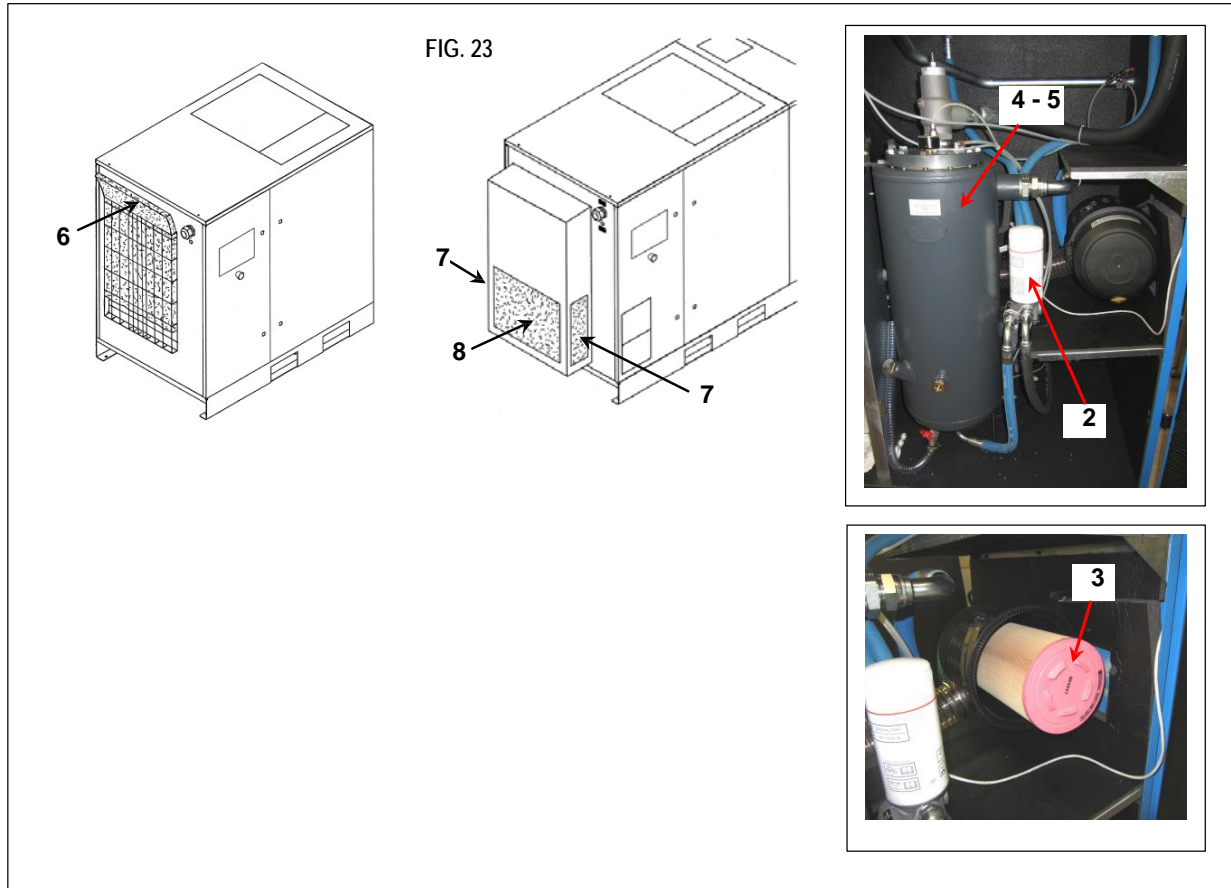

19.0 TROUBLE-SHOOTING AND EMERGENCY REMEDIES

N.B. OPERATIONS MARKED ■ ■ MUST BE PERFORMED BY PROFESSIONALLY SKILLED PERSONNEL APPROVED THE MANUFACTURER.



ALL WORK MUST BE PERFORMED BY PROFESSIONALLY SKILLED PERSONNEL. BEFORE CARRYING OUT ANY MAINTENANCE JOBS IT IS MANDATORY TO STOP THE MACHINE AND DISCONNECT IT FROM THE POWER MAINS.

19.1 TROUBLE-SHOOTING AND EMERGENCY REMEDIES FOR SCREW COMPRESSOR (Standard controller for fixed speed compressor)

FAULT FOUND	POSSIBLE CAUSES	OBSERVATIONS
1) The machine does not start	1A - no power 1B - the transformer protection device has tripped	- check the power supply line, Chapter 12.2 - replace fuses
2) The machine does not start the pilot lamp (Ref. 8 Fig. 15) is flashes. The pictograph appears intermittently (Ref. 7 Tab. B)	2A - Phases incorrect 2B - the main motor protection device has tripped 2C - Temperature switch on element outlet has tripped	- Verify phase sequence - to check possible motor failure -environment temperature too high; improve ventilation in the compressor room, Chapter 9.2 ■ ■ - cooling radiator is dirty, clean the radiator - oil level too low; top up the oil tank
3) The machine does not start the pilot lamp (Ref. 8 Fig. 15) is flashes. The pictograph appears intermittently (Ref. 5 Tab. B)	3A - The oil high temperature protection has tripped	- environment temperature too high; improve ventilation in the compressor room, Chapter 9.2 ■ ■ - cooling radiator is dirty, clean the radiator - oil level too low; top up the oil tank
4) The compressor does not reach working pressure	4A - the compressed air consumption is too high 4B - the discharge electrovalve remains closed.	■ ■ - check the electric system
5) Excess oil consumption	5A - deteriorated oil separating filter oil level is too high	■ ■ - change the oil separating filter, Chapter 23

19.2 - TROUBLE-SHOOTING AND EMERGENCY REMEDIES FOR SCREW COMPRESSOR (Graphic controller for fixed speed compressor)

FAULT FOUND	POSSIBLE CAUSES	OBSERVATIONS
1) The machine does not start	1A - no power 1B - the transformer protection device has tripped	- check the power supply line, Chapter 12.2 - replace fuses
2) The machine does not start the pilot lamp (Ref. 5 Fig.16) is flashes. The pictograph appears intermittently (Status icons Shutdown)	2A - Phases incorrect 2B - the main motor protection device has tripped 2C - Temperature switch on element outlet has tripped	- Verify phases sequence - to check possible motor failure -environment temperature too high; improve ventilation in the compressor room, Chapter 9.2 ■ ■ - cooling radiator is dirty, clean the radiator - oil level too low; top up the oil tank
3) The machine does not start the pilot lamp (Ref. 5 Fig.16) is flashes. The pictograph appears intermittently (Status icons Shutdown)	3A - The oil high temperature protection has tripped	- environment temperature too high; improve ventilation in the compressor room, Chapter 9.2 ■ ■ - cooling radiator is dirty, clean the radiator - oil level too low; top up the oil tank
4) The compressor does not reach working pressure	4A - the compressed air consumption is too high 4B - the discharge electrovalve remains closed.	■ ■ - check the electric system
5) Excess oil consumption	5A - deteriorated oil separating filter oil level is too high	■ ■ - change the oil separating filter, Chapter 23

ENGLISH

19.3 TROUBLE-SHOOTING FOR REFRIGERANT DRYER



ALL WORK MUST BE PERFORMED BY PROFESSIONALLY SKILLED PERSONNEL. BEFORE CARRYING OUT ANY MAINTENANCE JOBS IT IS MANDATORY TO STOP THE MACHINE AND DISCONNECT IT FROM THE POWER MAINS.

N.B. OPERATIONS MARKED ■ ■ MUST BE PERFORMED BY PROFESSIONALLY SKILLED PERSONNEL APPROVED THE MANUFACTURER

FAULT FOUND	POSSIBLE CAUSES	OBSERVATIONS
1) No compressed air passes through the dryer outlet	1A) The pipes are frozen inside	■ ■ -Hot gas by-pass the bypass valve is broken or out-of-calibration -The room temperature is too low and the evaporators piping are obstructed with ice
2) Presence of condensate in the pipings.	2A) The condensate separator does not work correctly 2B) The dryer is working outside its rating 2C) The dryer is working under bad excessive conditions.	■ ■ -Check the solenoid exhaust valve ■ ■ -Check the drainage timer -Check the flow rate of treated air -Check the room temperature -Check the air temperature at the drier inlet. -Clean the condenser. ■ ■ -Check dryer fan operation.
3) The compressor head is very hot (> 55 °C – 131 °F).	Make reference to 2B Make reference to 2C 3A) The cooling circuit is not working with the right gas charge	■ ■ -Check if there are leaks of refrigerating gas. ■ ■ - Charge it again.
4) Motor cuts out on overload	Make reference to 2B Make reference to 2C Make reference to 3A	
5) The motor hums and does not start.	The line voltage is too low. You switched the machine off and on again without leaving enough time for the pressure balancing. The starting system of the motor is defective.	-Contact the electric power company -Wait a few minutes before starting the machine again. ■ ■ -Check the running and starting relays and condensers (if any)
6) The machine has stopped and does not restart even after a few minutes.	The overload protection with has intervened: make reference to 2B-2C-3A. The motor has burnt out.	
7) The compressor is very noisy.	Troubles with the internal mechanical parts or with the valves	



PART "B"

THIS PART "B" OF THE INSTRUCTIONS MANUAL IS RESERVED FOR PROFESSIONALLY SKILLED PERSONNEL APPROVED THE MANUFACTURER

20.0 STARTING UP

BEFORE PERFORMING ANY OPERATION ON THE MACHINE, ENSURE THAT THE ELECTRIC POWER SUPPLY HAS BEEN DISCONNECTED.

20.1 PREPARE FOR START**20.2 Preliminary checks**

Check the level Ref. 1 Fig. 24; when delivered, the machine is filled with oil; if the oil level is not as intended, top up with original oil. If unit is installed more than 3 months after factory inspection: lubricate the screw element before start.

According to below procedure:

- Remove the pipe Ref. 2 Fig. 24 by loosening the clamp screw.
- Pour a little oil into the inlet valve.
- Reassemble the pipe Ref. 2 Fig. 24

If more than 6 months elapsed between factory inspection and installation, please contact the service centre.

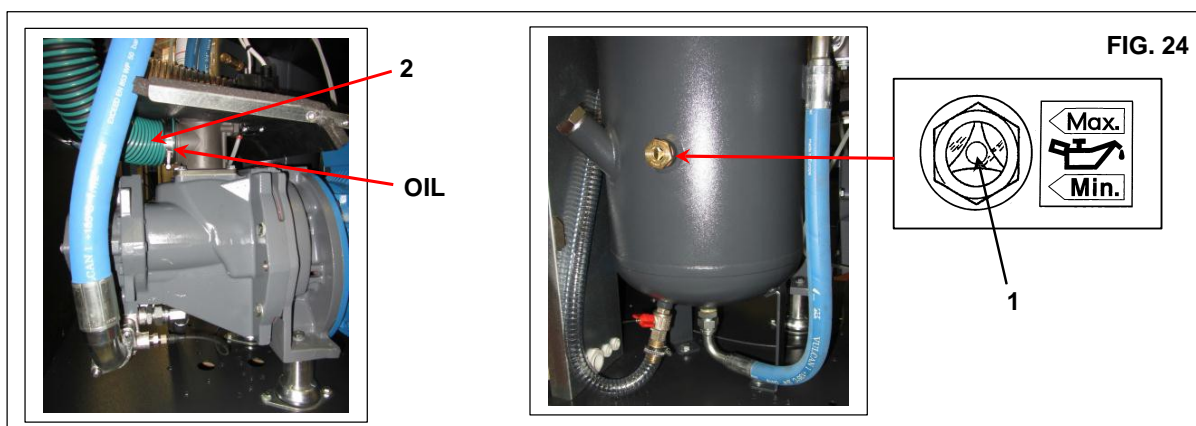

ENGLISH

20.3 CHECK THE DIRECTION OF ROTATION

- Check that all fixed guards are in their correct position.
- Connect the control board to the power supply with the automatic circuit-breaker switch of the line Rif. 1 Fig. 25.
- Check the direction of rotation (following the arrow on the coupling housing Rif. 3 Fig. 25). By pressing the "Start" button Rif. 2 Fig. 25, followed immediately by the emergency stop Rif. 4 Fig. 25. If it does not spin in the right direction reverse two mains cables. When it rotates in the correct direction, the oil level Rif. 5 Fig. 25. Should drop after 4 or 5 seconds of operation. It is very important to remember to check the direction of rotation of the fan (shown by an arrow on the fan Rif. 6 Fig. 25).



ALL MAINTENANCE ON ELECTRICAL PARTS, MUST BE PERFORMED BY PROFESSIONALLY SKILLED PERSONNEL.

- IT IS ADVISABLE TO NOT TAMPER WITH ELECTRIC CABINET

IF ALL THE INSTRUCTIONS FOUND IN THIS MANUAL HAVE BEEN OBSERVED THE MACHINE CAN BE STARTED.



ATTENTION: wait at least 20 seconds before starting the machine after a switch off

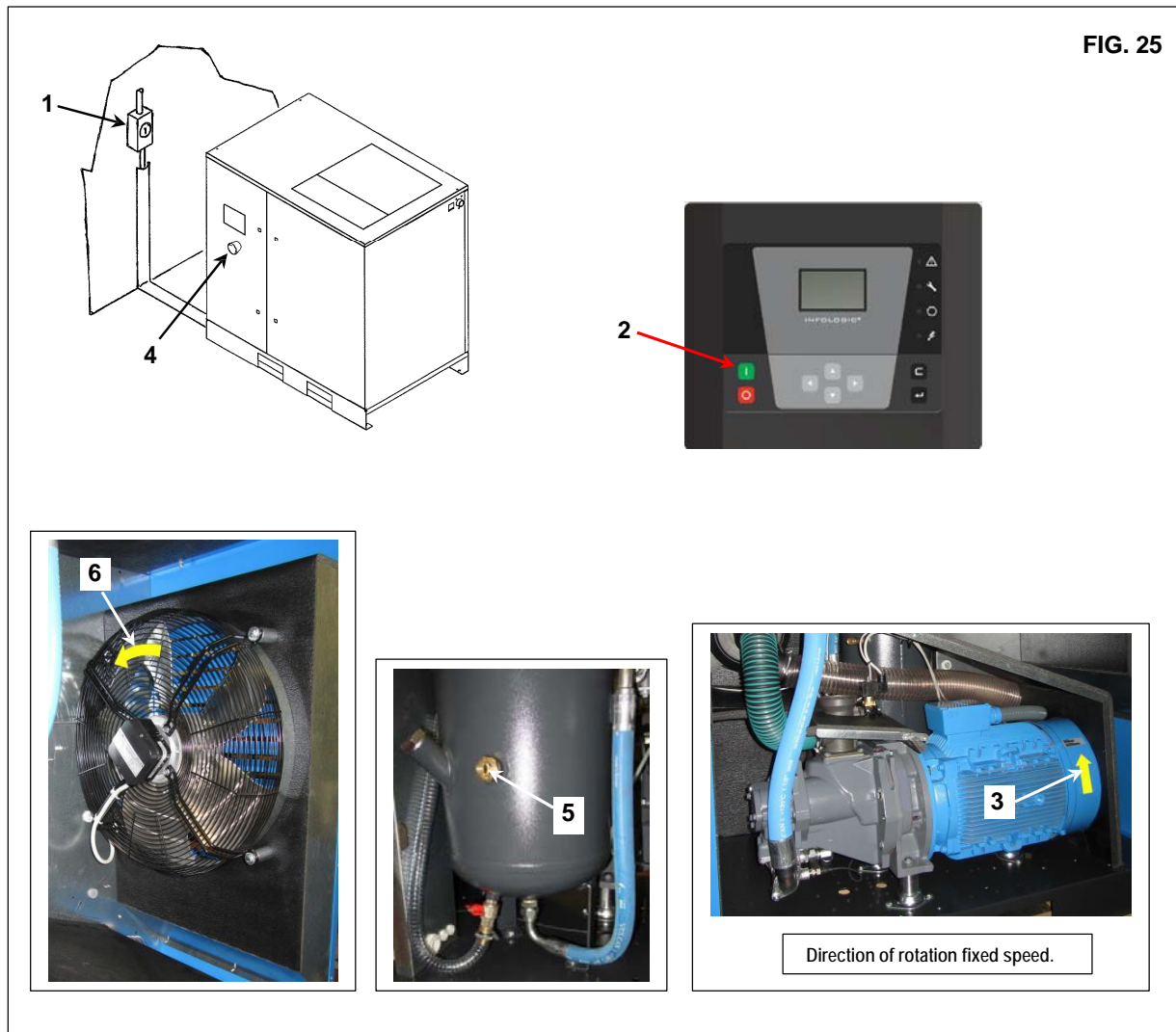

21.0 GENERAL ORDINARY MAINTENANCE REQUIRES TRAINED PERSONNEL

BEFORE CARRYING OUT ANY MAINTENANCE IT IS MANDATORY TO STOP THE MACHINE AND DISCONNECT IT FROM THE POWER MAINS.

MAINTENANCE SCHEDULE

These maintenance intervals are recommended for work environments that are not dusty and are well ventilated. For particularly dusty environments, double the frequency of controls.

Every Day (after use)	<ul style="list-style-type: none"> ■ Check automatic condensation drain (dryer)
Every 50 working hours	<ul style="list-style-type: none"> ■ Drain condensate from the oil tank ■ Check the oil level ■ Clean the filter of the automatic condensate drain (dryer)
Every 500 hours	<ul style="list-style-type: none"> ■ Replace oil (at first 500 hrs) ■ Replace oil filter (at first 500 hrs) ■ Tighten the screws fixing the electric cables (at first 500 hrs) ■ Clean the air inlet filter ■ Clean the condenser heat exchanger (unit with dryer) ■ Clean the inlet filtration panels
Every 2000 hours	<ul style="list-style-type: none"> ■ Replace the inlet air filter ■ ■ Replace the oil ■ ■ Replace the oil filter ■ ■ Retighten all power cable connections ■ ■ Safety temperature test ■ ■ Maintenance kit of the automatic condensate drain (dryer)
Every 4000 hours	<ul style="list-style-type: none"> ■ ■ Clean the finned surface of the air-oil cooler ■ ■ Replace the oil separator filter
Every 8000 hours	<ul style="list-style-type: none"> ■ ■ Intake valve service kit ■ ■ Check status of oil return valve and oil pipes ■ ■ MPV Service kit
Every 24000 hours	<ul style="list-style-type: none"> ■ ■ Air-end overhaul kit

N.B.: THE OPERATIONS MARKED ■ ARE DESCRIBED IN PART "A" OF THIS MANUAL ON CHAPTER 15.2

22.0 REPLACING OIL



BEFORE PERFORMING ANY MAINTENANCE JOBS IT IS MANDATORY TO STOP THE MACHINE AND DISCONNECT IT FROM THE POWER MAINS AND FROM THE COMPRESSED AIR DISTRIBUTION NETWORK.

Oil replacing is an important operation for the compressor:

if the lubrication of the bearings is not efficient, The life expectancy of the compressor will be significantly reduced.

The oil must be changed when the machine is still warm, that is immediately after stopping it.

The suggestions listed below should be scrupulously followed.

After draining the old oil out of the machine Ref. 2 Fig. 26.

- Completely fill the oil collector Ref. 1 Fig. 26.

- Remove the pipe Ref. 3 Fig. 26

- Pour a little oil into the suction unit.

- Reassemble the pipe Ref. 3 Fig. 26

- Start the compressor.

- After about 1 minute switch off the machine by pressing "STOP" (Ref. 4 Fig. 26) after idle time running the machine will switch off.

PROCEED AS DESCRIBED AT POINT CHAPTER 15.4

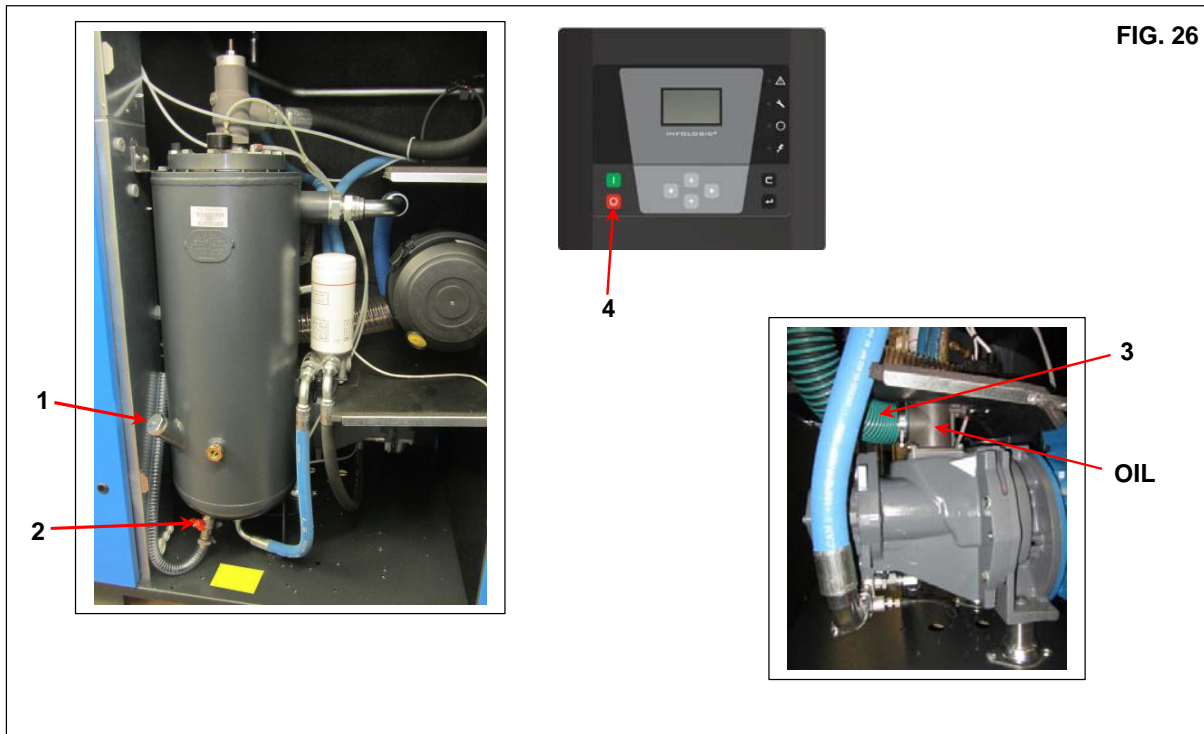

THE OLD OIL MUST BE DISPOSED OF IN COMPLIANCE WITH THE REGULATIONS IN FORCE.

NOTE ON LUBRICANTS

When delivered the machine is filled with oil.

In normal conditions of use, these lubricants have proved to be able to withstand use for as many as 4.000 hours. However, due to the external polluting agents that get into the compressor with the air that it takes in, it is advisable to change the oil at more frequent intervals, as indicated on the routine maintenance table. If the compressor is used at high temperatures (continuous operation with oil temperature above 90 °C – 194 °F) or in particularly severe conditions, we advise shorter oil replacement interval.

DO NOT TOP UP WITH DIFFERENT OILS

23 REPLACING OIL FILTER AND OIL SEPARATOR FILTER



BEFORE PERFORMING ANY MAINTENANCE THE MACHINE MUST BE STOPPED, CUT OFF THE MACHINE FROM THE ELECTRICAL MAINS AND FROM THE COMPRESSED AIR DISTRIBUTION CIRCUIT, CHECK THAT THE MACHINE IS NOT UNDER PRESSURE.

REPLACING OIL SEPARATOR FILTER

Before proceeding with the replacement of the de-oiler filter or the oil filter check that there is no pressure in the machine: check the pressure gauge Ref. 1 Fig. 28.

- Switch off the machine press Ref. 2 Fig. 28: in this way the machine stops after idle time running
- Switch off the main switch, Ref. 3 (on the screw-compressor) and Ref. 4 (on the dryer if fitted) Fig. 28
- Disconnect the unit from compressed air network Ref. 5 Fig. 28
- Check there is no pressure inside the machine: check the pressure gauge Ref. 1 Fig. 28.
- Remove the oil separator cover Ref. 6 Fig. 28
- Replace oil separator filter and gasket
- Moisturise gaskets with oil.

REPLACING OIL FILTER

- Remove the oil filter Ref. 7 Fig. 28
- Lubricate the filter seals with a little oil before fitting.
- Tightening must be done by hand.

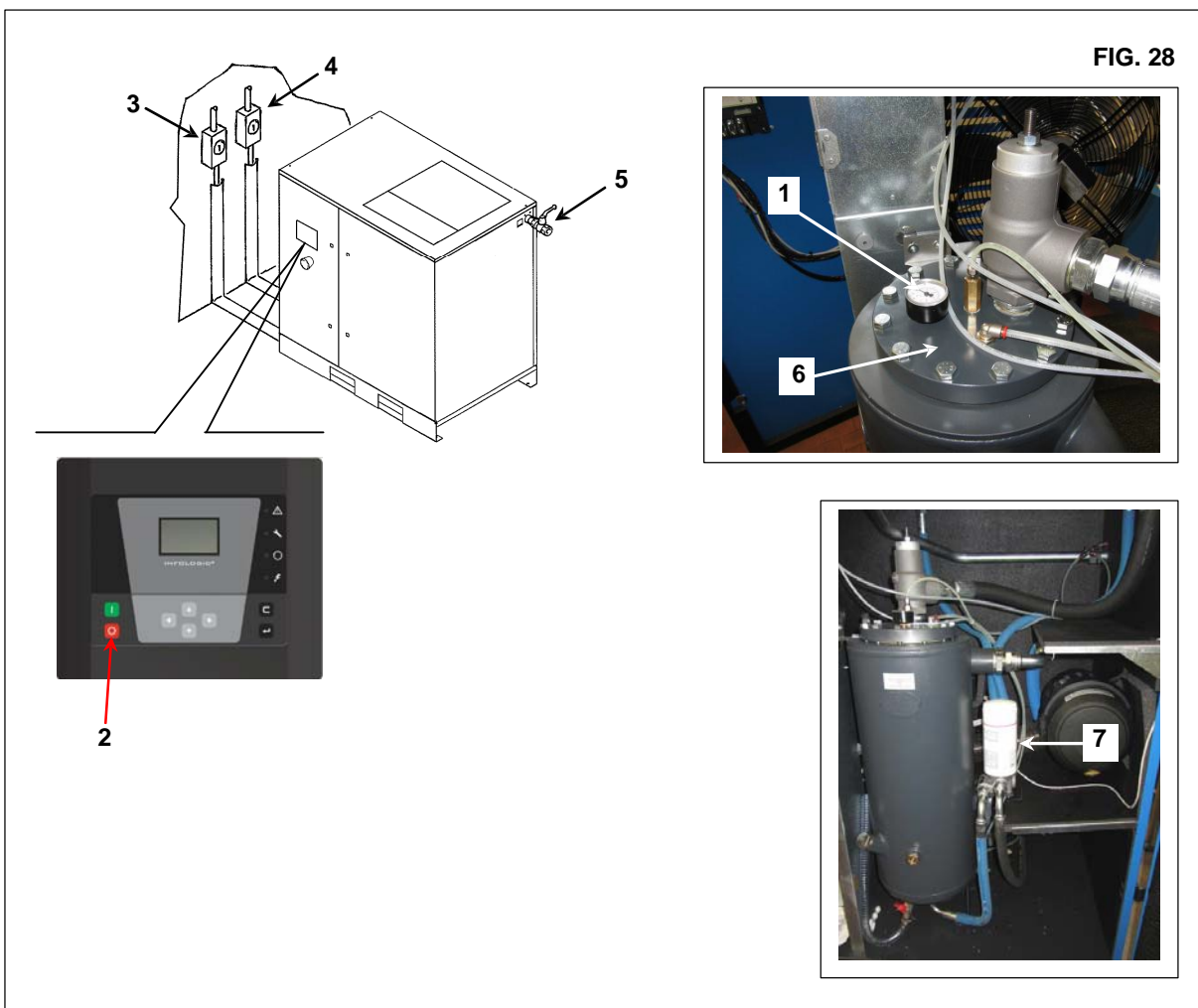

24.0 OLEOPNEUMATIC DIAGRAM

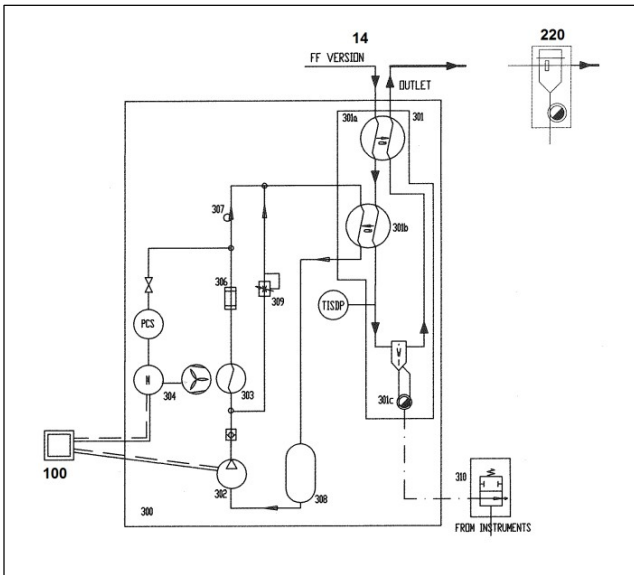
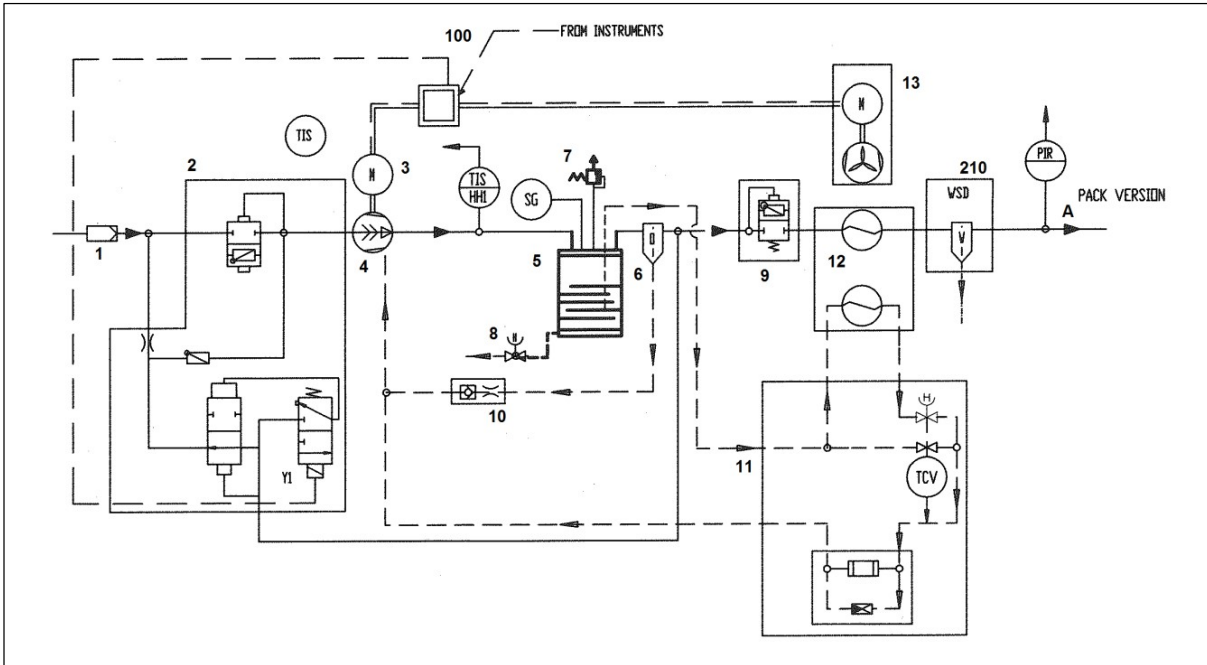

1 INLET FILTER	12 COMBI-COOLER
2 INLET VALVE	13 FAN
3 ELECTRIC MOTOR	14 REFRIGERANT DRYER
4 AIR END	100 CONTROL PANEL
5 OIL VESSEL	210 OPTIONAL WATER SEPARATOR
6 OIL SEPARATOR	220 OPTIONAL LINE FILTER
7 SAFETY VALVE	
8 OIL DRAIN	
9 MINIMUM PRESSURE VALVE	
10 CHECK VALVE	
11 THERMOSTATIC VALVE	

25.0 CALIBRACION FOR DRYER

HOT BYPASS VALVE

N.B. These valves are calibrated at the factory. A different dew point (from rated) may be related to different cause than HGBP.

- 1) Closing cap
- 2) Adjusting screw

WORKING PRESSURE AND TEMPERATURE OF R134a / R404a

	SUCTION SIDE OF REFRIGERATION COMPRESSOR		
	Evaporat. Temperat. °C (°F)	Evaporating Pressure bar (psi)	Evaporating Pressure bar (psi)
RATED VALUES (Temperat. 20 °C – 68 °F)	1 ÷ 2 (33,8 ÷ 35,6)	R134A 2,1 ÷ 2,3 (30,4 ÷ 33,3)	R404A 4,3 ÷ 4,5 (62,3 ÷ 65,2)

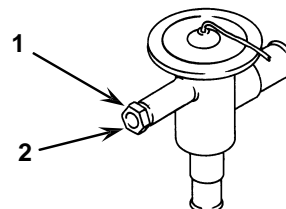

25.1 FLOW DIAGRAM OF THE DRYER

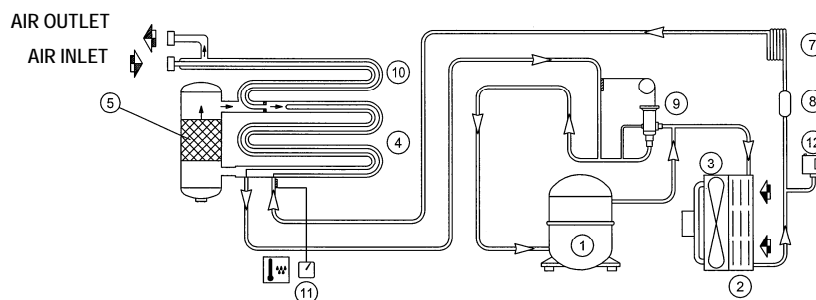

1 COMPRESSOR	8 REFRIGERANT FILTER
2 CONDENSER	9 HOT GAS BYPASS VALVE
3 MOTOR FAN	10 AIR-TO-AIR EXCANGER
4 EVAPORATOR	11 DEW POINT THERMOMETER
5 SEPARATOR	12 FAN PRESSURE SWITCH
7 EXPANSION CAPILLARY TUBE	

