

All materials specified are in compliance with the requirements of the List of Prohibited Substances

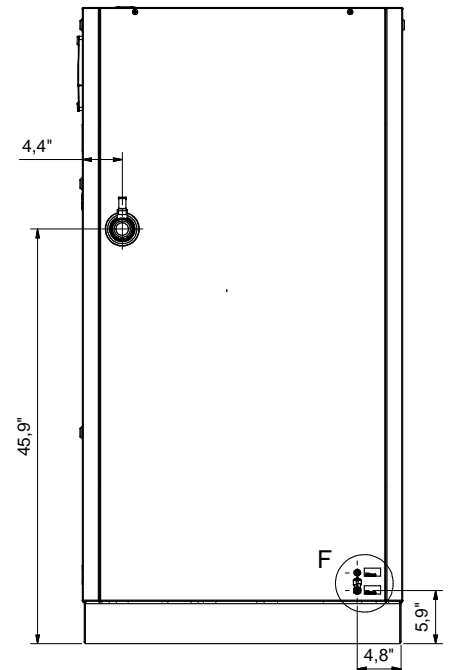
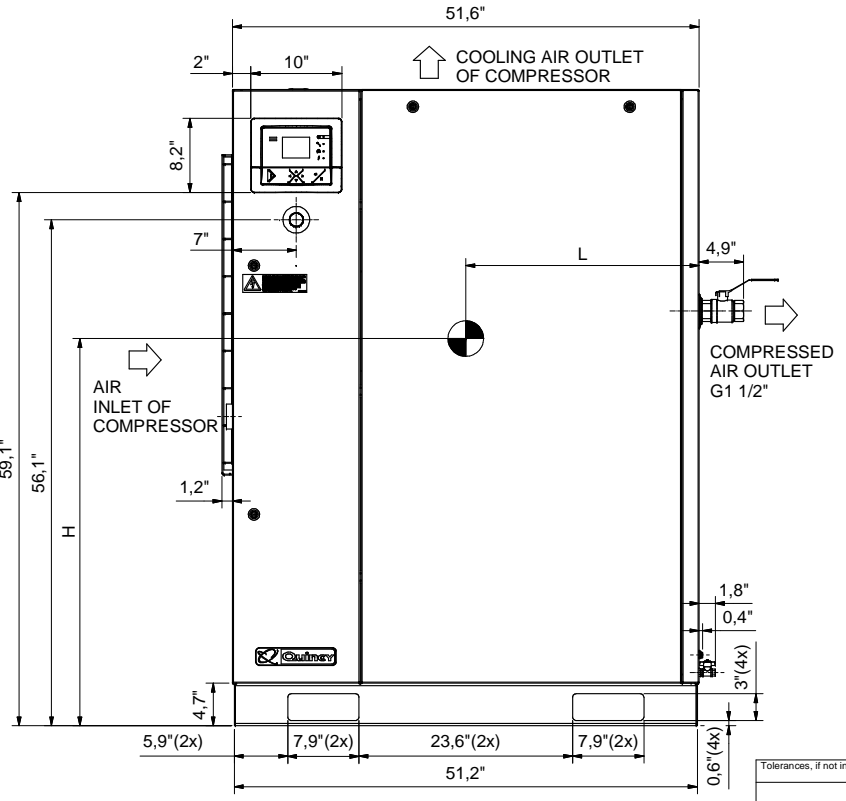
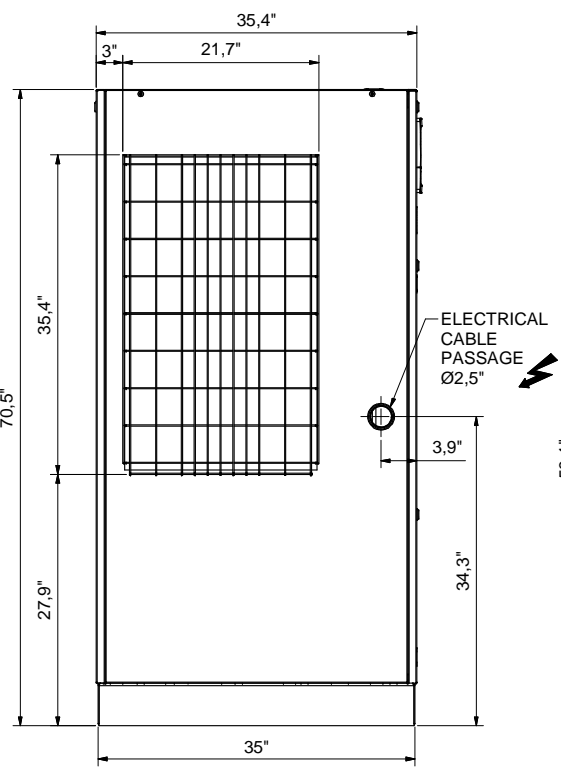
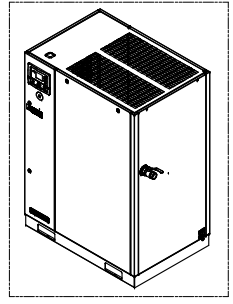
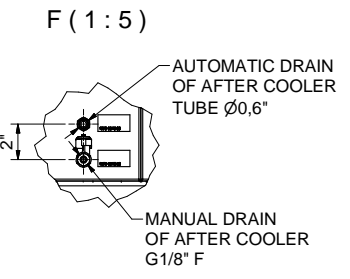
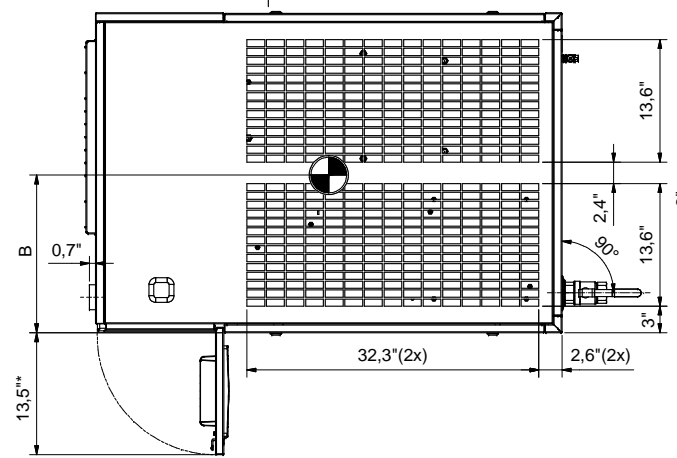
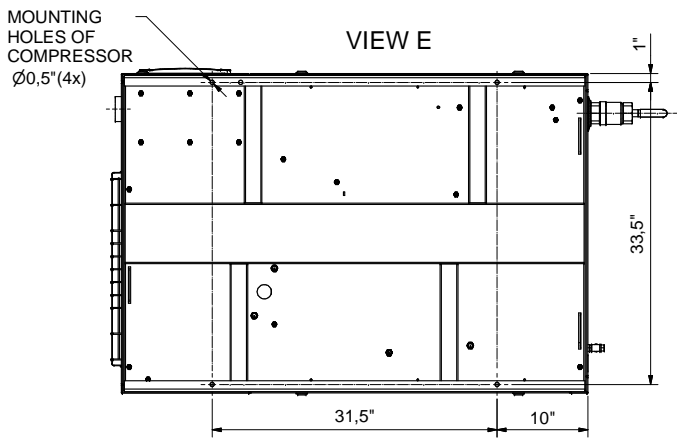

CENTER OF GRAVITY ± 2(inches)				APPROX. MASS ± 110(lbs)	
TYPE	L	B	H	TYPE	MASS
QGD40	28,7	16,1	35,8	QGD40	1415
QGD50	28,7	16,1	35,8	QGD50	1536
QGD60	23	18,8	48,7	QGD60	1639

* DOORS FULLY OPEN

Tolerances, if not indicated, according to:											
Name DIMENSION DRAWING						QGD40-60 PACK			Confidentiality Class		
Material Not Applicable						Internal			INV		
Treatment Not Applicable						Internal			INV		
Scale 1:10				Family		Compare		Drawing owner			
Drawn by INEmamar				Blank nr.		Replaces		API			
Drawing format A2				Blank wt.		Kg		Fini wt.		N/A	
STATUS				Des checked.		Prod checked.		Approved.		Date 07-03-2016	
Preliminary						9828510238					

CONFIDENTIAL: This document is our property and shall not be distributed without our permission. All rights reserved. No part of this document may be reproduced or transmitted in any form or by any means electronic or mechanical, including photocopying and recording, or by any information storage or retrieval system, without permission in writing from the manufacturer or distributor of any product mentioned herein.

Ed	Position	Modified from	Date	Intr./Appd.

Parent 3D model	Edition 3D
-----------------	------------

A
B
C
D
E
F
G