

Quincy

Oil-injected rotary screw compressors



QGD 40, QGD 50, QGD 60

Instruction book



Quincy

Oil-injected rotary screw compressors

QGD 40, QGD 50, QGD 60

Instruction book

Original instructions

Copyright notice

Any unauthorized use or copying of the contents or any part thereof is prohibited.

This applies in particular to trademarks, model denominations, part numbers and drawings.

This instruction book is valid for CE as well as non-CE labelled machines. It meets the requirements for instructions specified by the applicable European directives as identified in the Declaration of Conformity.

2021 - 08

No. 2920 7190 02

www.quincycompressor.com

Quincy
COMPRESSOR

Table of contents

1	Safety precautions.....	5
1.1	SAFETY ICONS.....	5
1.2	GENERAL SAFETY PRECAUTIONS.....	5
1.3	SAFETY PRECAUTIONS DURING INSTALLATION.....	6
1.4	SAFETY PRECAUTIONS DURING OPERATION.....	7
1.5	SAFETY PRECAUTIONS DURING MAINTENANCE OR REPAIR.....	8
1.6	DISMANTLING AND DISPOSAL.....	10
2	General description.....	11
2.1	INTRODUCTION.....	11
2.2	AIR AND OIL CIRCUIT.....	17
2.3	COOLING SYSTEM.....	20
2.4	CONDENSATE SYSTEM.....	20
2.5	REGULATING SYSTEM.....	22
2.6	ELECTRICAL SYSTEM.....	23
2.7	AIR DRYER.....	24
3	Graphic controller.....	26
3.1	CONTROLLER.....	26
3.2	CONTROL PANEL.....	28
3.3	ICONS USED.....	29
3.4	MAIN SCREEN.....	32
3.5	CALLING UP MENUS.....	36
3.6	INPUTS MENU.....	36
3.7	OUTPUTS MENU.....	39
3.8	COUNTERS.....	40
3.9	CONTROL MODE SELECTION.....	41
3.10	SERVICE MENU.....	42



3.11	REGULATION MENU.....	46
3.12	EVENT HISTORY MENU.....	47
3.13	MODIFYING GENERAL SETTINGS.....	48
3.14	WEEK TIMER MENU.....	50
3.15	TEST MENU.....	59
3.16	GENERAL MENU.....	60
3.17	USER PASSWORD MENU.....	61
3.18	ACCESS KEY MENU.....	62
3.19	PROGRAMMABLE SETTINGS.....	63
4	Installation.....	65
4.1	DIMENSION DRAWINGS.....	65
4.2	INSTALLATION PROPOSAL.....	65
4.3	ELECTRICAL CONNECTIONS.....	69
4.4	PICTOGRAPHS.....	70
5	Operating instructions.....	73
5.1	INITIAL START-UP.....	73
5.2	BEFORE STARTING.....	76
5.3	STARTING	78
5.4	DURING OPERATION.....	78
5.5	CHECKING THE DISPLAY.....	81
5.6	STOPPING	81
5.7	TAKING OUT OF OPERATION.....	81
6	Maintenance.....	83
6.1	PREVENTIVE MAINTENANCE SCHEDULE.....	83
6.2	OIL SPECIFICATIONS.....	85
6.3	DRIVE MOTOR	85
6.4	AIR FILTER.....	86

6.5	OIL AND OIL FILTER CHANGE.....	87
6.6	COOLERS.....	88
6.7	SAFETY VALVES.....	90
6.8	DRYER MAINTENANCE INSTRUCTIONS.....	90
6.9	SERVICE KITS.....	91
6.10	STORAGE AFTER INSTALLATION.....	92
7	Problem solving.....	93
8	Technical data.....	97
8.1	READINGS ON DISPLAY.....	97
8.2	ELECTRIC CABLE SIZE AND FUSES.....	98
8.3	PROTECTION SETTINGS.....	101
8.4	DRYER SWITCHES.....	101
8.5	REFERENCE CONDITIONS AND LIMITATIONS.....	102
8.6	COMPRESSOR DATA.....	102
9	Instructions for use.....	106
10	Guidelines for inspection.....	107
11	Pressure equipment directives.....	108
12	Declaration of conformity.....	109

1 Safety precautions

1.1 Safety icons

Explanation

	Danger to life
	Warning
	Important note

1.2 General safety precautions

1. The operator must employ safe working practices and observe all related work safety requirements and regulations.
2. If any of the following statements does not comply with the applicable legislation, the stricter of the two shall apply.
3. Installation, operation, maintenance and repair work must only be performed by authorized, trained, specialized personnel. The personnel should apply safe working practices by use of personal protection equipment, appropriate tools and defined procedures.
4. The compressor is not considered capable of producing air of breathing quality. For air of breathing quality, the compressed air must be adequately purified according to the applicable legislation and standards.
5. Before any maintenance, repair work, adjustment or any other non-routine checks:
 - Stop the machine
 - Press the emergency stop button
 - Switch off the voltage
 - Depressurize the machine
 - Lock Out - Tag Out (LOTO):
 - Open the power isolating switch and lock it with a personal lock
 - Tag the power isolating switch with the name of the service technician.
 - On units powered by a frequency converter, wait 10 minutes before starting any electrical repair.
 - Never rely on indicator lamps or electrical door locks before maintenance work, always disconnect and check with measuring device.

	If the machine is equipped with an automatic restart after voltage failure function and if this function is active, be aware that the machine will restart automatically when the power is restored if it was running when the power was interrupted!
---	---

6. Never play with compressed air. Do not apply the air to your skin or direct an air stream at people. Never use the air to clean dirt from your clothes. When using the air to clean equipment, do so with extreme caution and wear eye protection.
7. The owner is responsible for maintaining the unit in safe operating condition. Parts and accessories shall be replaced if unsuitable for safe operation.
8. It is prohibited to walk or stand on the unit or on its components.

9. If compressed air is used in the food industry and more specifically for direct food contact, it is recommended, for optimal safety, to use certified Class 0 compressors in combination with appropriate filtration depending on the application. Please contact your customer center for advice on specific filtration.
10. The service switch should only be operated by a trained service specialist from the manufacturer.

1.3 Safety precautions during installation



All responsibility for any damage or injury resulting from neglecting these precautions, or non-observance of the normal caution and care required for installation, operation, maintenance and repair, even if not expressly stated, will be disclaimed by the manufacturer.

Precautions during installation

1. The machine must only be lifted using suitable equipment in accordance with the applicable safety regulations. Loose or pivoting parts must be securely fastened before lifting. It is strictly forbidden to dwell or stay in the risk zone under a lifted load. Lifting acceleration and deceleration must be kept within safe limits. Wear a safety helmet when working in the area of overhead or lifting equipment.
2. The unit is designed for indoor use. If the unit is installed outdoors, special precautions must be taken. Consult your supplier.
3. In case the device is a compressor, place the machine where the ambient air is as cool and clean as possible. If necessary, install a suction duct. Never obstruct the air inlet. Care must be taken to minimize the entry of moisture at the inlet air.
4. Any blanking flanges, plugs, caps and desiccant bags must be removed before connecting the pipes.
5. Air hoses must be of correct size and suitable for the working pressure. Never use frayed, damaged or worn hoses. Distribution pipes and connections must be of the correct size and suitable for the working pressure.
6. In case the device is a compressor, the aspirated air must be free of flammable fumes, vapors and particles, e.g. paint solvents, that can lead to internal fire or explosion.
7. In case the device is a compressor, arrange the air intake so that loose clothing worn by people cannot be drawn in.
8. Ensure that the discharge pipe from the compressor to the aftercooler or air net is free to expand under heat and that it is not in contact with or close to flammable materials.
9. No external force may be exerted on the air outlet valve; the connected pipe must be free of strain.
10. If remote control is installed, the machine must bear a clear sign stating: DANGER: This machine is remotely controlled and may start without warning.
The operator has to make sure that the machine is stopped and depressurized and that the electrical isolating switch is open, locked and labelled with a temporary warning before any maintenance or repair. As a further safeguard, persons switching on or off remotely controlled machines shall take adequate precautions to ensure that there is no one checking or working on the machine. To this end, a suitable notice shall be affixed to the start equipment.
11. Air-cooled machines must be installed in such a way that an adequate flow of cooling air is available and that the exhausted air does not recirculate to the compressor air inlet or cooling air inlet.

12. The electrical connections must correspond to the applicable codes. The machines must be earthed and protected against short circuits by fuses in all phases. A lockable power isolating switch must be installed near the compressor.
13. On machines with automatic start/stop system or if the automatic restart function after voltage failure is activated, a sign stating "This machine may start without warning" must be affixed near the instrument panel.
14. In multiple compressor systems, manual valves must be installed to isolate each compressor. Non-return valves (check valves) must not be relied upon for isolating pressure systems.
15. Never remove or tamper with the safety devices, guards or insulation fitted on the machine. Every pressure vessel or auxiliary installed outside the machine to contain air above atmospheric pressure must be protected by a pressure relieving device or devices as required.
16. Piping or other parts with a temperature in excess of 70°C (158°F) and which may be accidentally touched by personnel in normal operation must be guarded or insulated. Other high temperature piping must be clearly marked.
17. For water-cooled machines, the cooling water system installed outside the machine has to be protected by a safety device with set pressure according to the maximum cooling water inlet pressure.
18. If the ground is not level or can be subject to variable inclination, consult the manufacturer.
19. If the device is a dryer and no free extinguishing system is present in the air net close to the dryer, safety valves must be installed in the vessels of the dryer.



Also consult the following safety precautions: [Safety precautions during operation](#) and [Safety precautions during maintenance](#).
 These precautions apply to machinery processing or consuming air or inert gas. Processing of any other gas requires additional safety precautions typical to the application which are not included herein.
 Some precautions are general and cover several machine types and equipment; hence some statements may not apply to your machine.

1.4 Safety precautions during operation



All responsibility for any damage or injury resulting from neglecting these precautions, or non observance of the normal caution and care required for installation, operation, maintenance and repair, even if not expressly stated, will be disclaimed by the manufacturer.

Precautions during operation

1. Never touch any piping or components of the machine during operation.
2. Use only the correct type and size of hose end fittings and connections. When blowing through a hose or air line, ensure that the open end is held securely. A free end will whip and may cause injury. Make sure that a hose is fully depressurized before disconnecting it.
3. Persons switching on remotely controlled machines shall take adequate precautions to ensure that there is no one checking or working on the machine. To this end, a suitable notice shall be affixed to the remote start equipment.
4. Never operate the machine when there is a possibility of taking in flammable or toxic fumes, vapors or particles.
5. Never operate the machine below or in excess of its limit ratings.

6. Keep all bodywork doors shut during operation. The doors may be opened for short periods only, e.g. to carry out routine checks. Wear ear protectors when opening a door. On machines without bodywork, wear ear protection in the vicinity of the machine.
7. People staying in environments or rooms where the sound pressure level reaches or exceeds 80 dB(A) shall wear ear protectors.
8. Periodically check that:
 - All guards are in place and securely fastened
 - All hoses and/or pipes inside the machine are in good condition, secure and not rubbing
 - No leaks occur
 - All fasteners are tight
 - All electrical leads are secure and in good order
 - Safety valves and other pressure relief devices are not obstructed by dirt or paint
 - Air outlet valve and air net, i.e. pipes, couplings, manifolds, valves, hoses, etc. are in good repair, free of wear or abuse
 - Air cooling filters of the electrical cabinet are not clogged
9. If warm cooling air from compressors is used in air heating systems, e.g. to warm up a workroom, take precautions against air pollution and possible contamination of the breathing air.
10. On water-cooled compressors using open circuit cooling towers, protective measures must be taken to avoid the growth of harmful bacteria such as Legionella pneumophila bacteria.
11. Do not remove any of, or tamper with, the sound-damping material.
12. Never remove or tamper with the safety devices, guards or insulations fitted on the machine. Every pressure vessel or auxiliary installed outside the machine to contain air above atmospheric pressure shall be protected by a pressure relieving device or devices as required.
13. Yearly inspect the air receiver. Minimum wall thickness as specified in the instruction book must be respected. Local regulations remain applicable if they are more strict.



Also consult following safety precautions: [Safety precautions during installation](#) and [Safety precautions during maintenance](#).
 These precautions apply to machinery processing or consuming air or inert gas. Processing of any other gas requires additional safety precautions typical to the application which are not included herein.
 Some precautions are general and cover several machine types and equipment; hence some statements may not apply to your machine.

1.5 Safety precautions during maintenance or repair



All responsibility for any damage or injury resulting from neglecting these precautions, or non observance of the normal caution and care required for installation, operation, maintenance and repair, even if not expressly stated, will be disclaimed by the manufacturer.

Precautions during maintenance or repair

1. Always use the correct safety equipment (such as safety glasses, gloves, safety shoes, etc.).
2. Use only the correct tools for maintenance and repair work.

3. Use only genuine spare parts for maintenance or repair. The manufacturer will disclaim all damage or injuries caused by the use of non-genuine spare parts.
4. All maintenance work shall only be undertaken when the machine has cooled down.
5. A warning sign bearing a legend such as "Work in progress; do not start" shall be attached to the starting equipment.
6. Persons switching on remotely controlled machines shall take adequate precautions to ensure that there is no one checking or working on the machine. To this end, a suitable notice shall be affixed to the remote start equipment.
7. Close the compressor air outlet valve and depressurize the compressor before connecting or disconnecting a pipe.
8. Before removing any pressurized component, effectively isolate the machine from all sources of pressure and relieve the entire system of pressure.
9. Never use flammable solvents or carbon tetrachloride for cleaning parts. Take safety precautions against toxic vapors of cleaning liquids.
10. Scrupulously observe cleanliness during maintenance and repair. Keep dirt away by covering the parts and exposed openings with a clean cloth, paper or tape.
11. Never weld or perform any operation involving heat near the oil system. Oil tanks must be completely purged, e.g. by steam cleaning, before carrying out such operations. Never weld on, or in any way modify, pressure vessels.
12. Whenever there is an indication or any suspicion that an internal part of a machine is overheated, the machine shall be stopped but no inspection covers shall be opened before sufficient cooling time has elapsed; this to avoid the risk of spontaneous ignition of the oil vapor when air is admitted.
13. Never use a light source with open flame for inspecting the interior of a machine, pressure vessel, etc.
14. Make sure that no tools, loose parts or rags are left in or on the machine.
15. All regulating and safety devices shall be maintained with due care to ensure that they function properly. They may not be put out of action.
16. Before clearing the machine for use after maintenance or overhaul, check that operating pressures, temperatures and time settings are correct. Check that all control and shut-down devices are fitted and that they function correctly. If removed, check that the coupling guard of the compressor drive shaft has been reinstalled.
17. Every time the separator element is renewed, examine the discharge pipe and the inside of the oil separator vessel for carbon deposits; if excessive, the deposits should be removed.
18. Protect the motor, air filter, electrical and regulating components, etc. to prevent moisture from entering them, e.g. when steam cleaning.
19. Make sure that all sound-damping material and vibration dampers, e.g. damping material on the bodywork and in the air inlet and outlet systems of the compressor, is in good condition. If damaged, replace it by genuine material from the manufacturer to prevent the sound pressure level from increasing.
20. Never use caustic solvents which can damage materials of the air net, e.g. polycarbonate bowls.
21. **Only if applicable, the following safety precautions are stressed when handling refrigerant:**
 - Never inhale refrigerant vapors. Check that the working area is adequately ventilated; if required, use breathing protection.
 - Always wear special gloves. In case of refrigerant contact with the skin, rinse the skin with water. If liquid refrigerant contacts the skin through clothing, never tear off or remove the latter; flush abundantly with fresh water over the clothing until all refrigerant is flushed away; then seek medical first aid.



Also consult following safety precautions: [Safety precautions during installation](#) and [Safety precautions during operation](#).
 These precautions apply to machinery processing or consuming air or inert gas. Processing of any other gas requires additional safety precautions typical to the application which are not included herein.
 Some precautions are general and cover several machine types and equipment; hence some statements may not apply to your machine.

1.6 Dismantling and disposal

Dismantling

Once the end of life of the machine is reached, please follow next steps:

1. Stop the machine.
2. Check all safety precautions mentioned in the previous chapters to secure safe handling (e.g. LOTO, cool-down, depressurize, discharge, ...).
3. Separate the harmful from the safe components (e.g. drain oil from oil containing parts).
4. Refer to the disposal topic mentioned below.

Disposal of electrical and electronic appliances (WEEE)

This equipment falls under the provisions of the European Directive 2012/19/EU on waste electrical and electronic appliances (WEEE) and may not be disposed as unsorted waste.



The equipment is labelled in accordance with the European Directive 2012/19/EU with the crossed-out wheeled bin symbol.

At the end of life-time of the electric and electronic equipment (EEE) it must be taken to separate collection.

For more information check with your local waste authority, customer center or distributor.

Disposal of other used material

Used filters or any other used material (e.g. filter bags, filter media, desiccant, lubricants, cleaning rags, machine parts, etc.) must be disposed of in an environmentally friendly and safe manner, and in line with the local recommendations and environmental legislation.

2 General description

2.1 Introduction

QGD 40, QGD 50 and QGD 60 are air cooled single-stage, oil-injected screw compressors, driven by an electric motor.

The compressors are controlled by an Airlogic² controller. The controller is fitted to the left hand door panel on the front side. An electric cabinet comprising the motor starter is located behind this panel.

The compressors are enclosed in a sound-insulated bodywork.

Two compressors versions are available: a version without integrated dryer and a version with integrated dryer.

The dryer removes water from the compressed air by cooling the air to near freezing point.

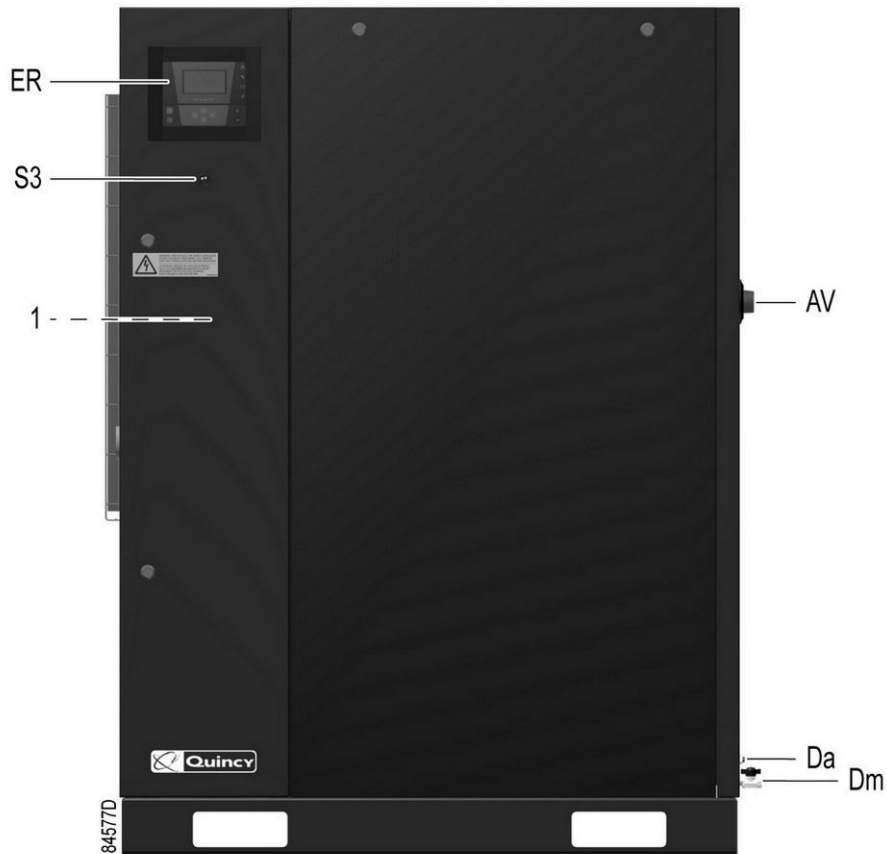

Front view, compressors without dryer



Front view, compressors with integrated dryer

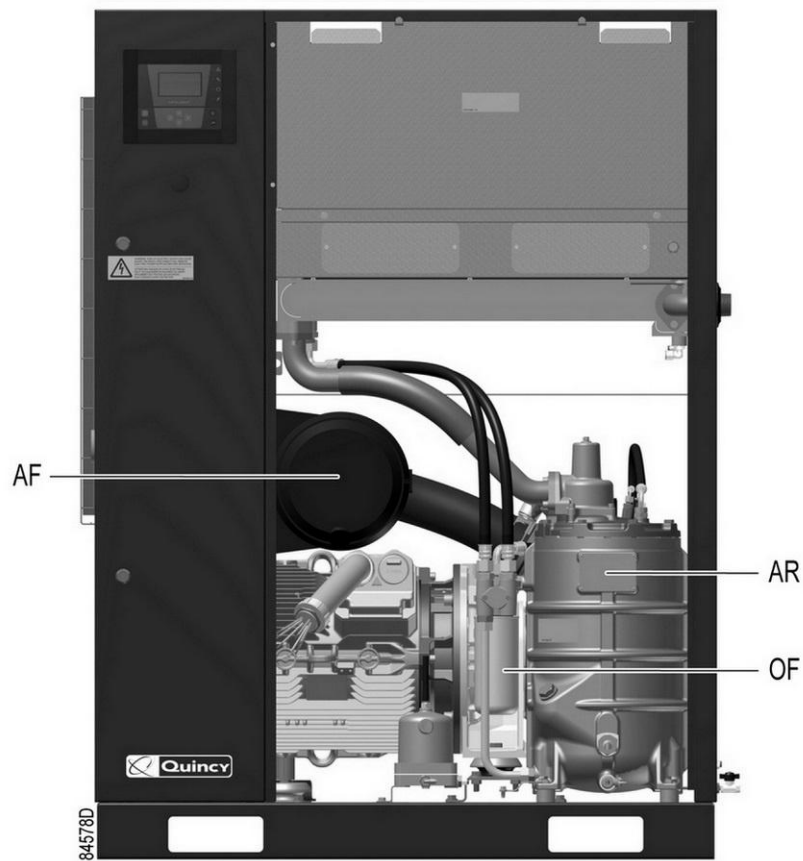

Front view open, compressors without dryer

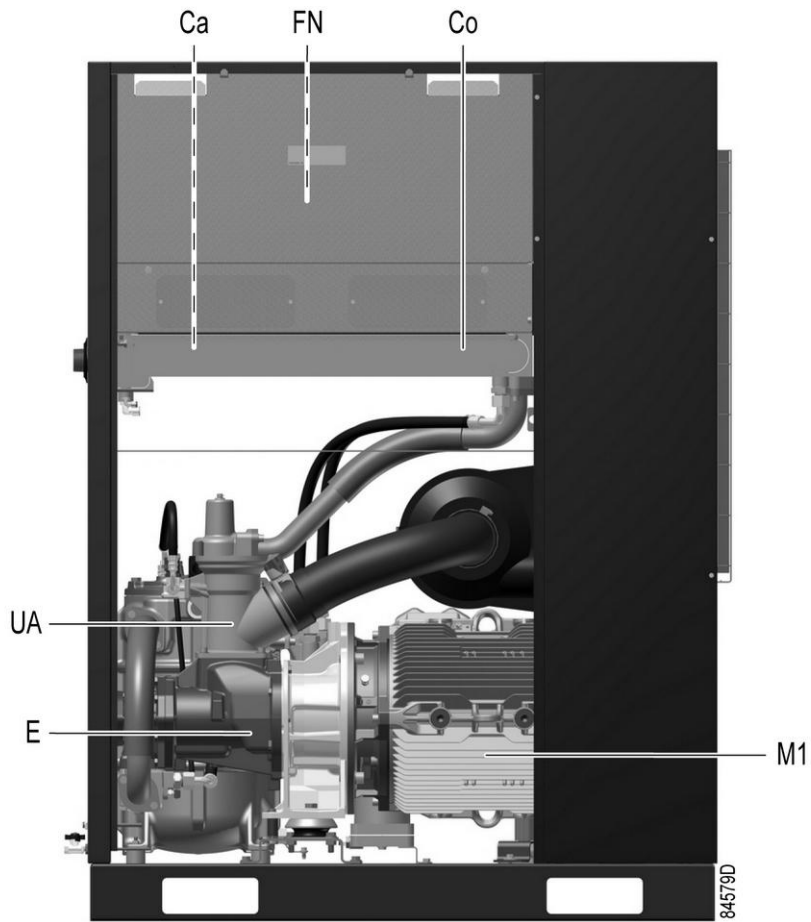

Rear view, compressors without dryer

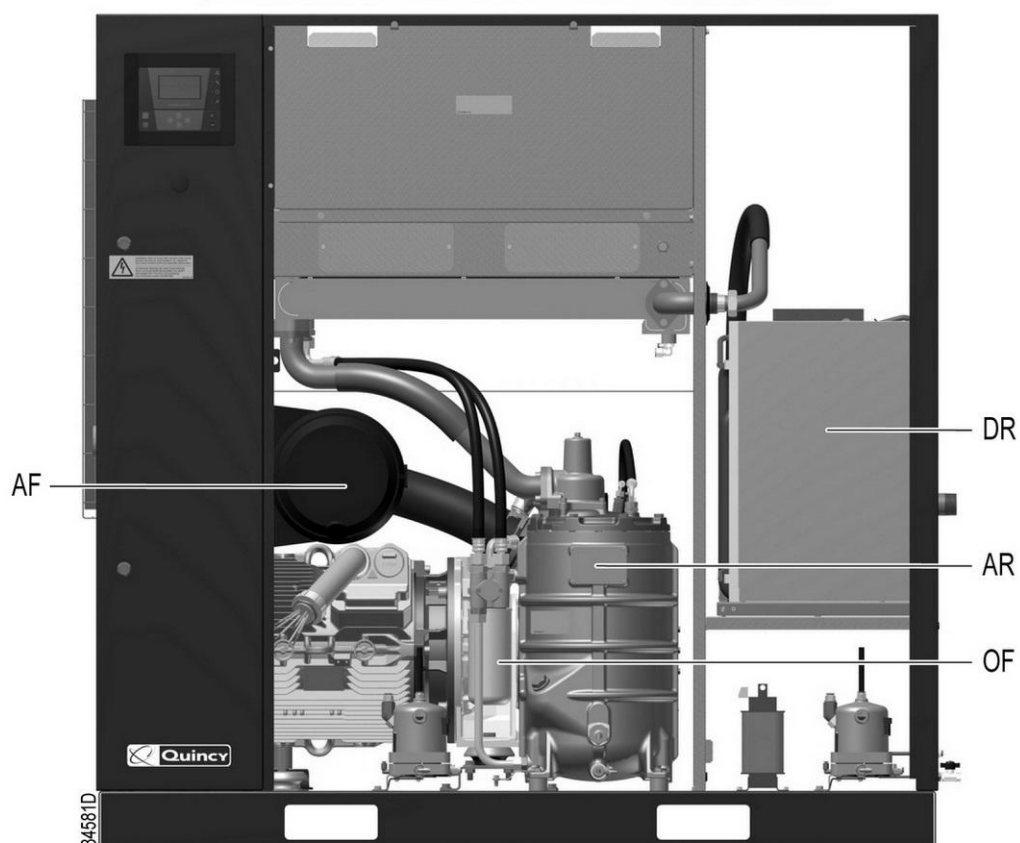

Front view open, compressors with integrated dryer

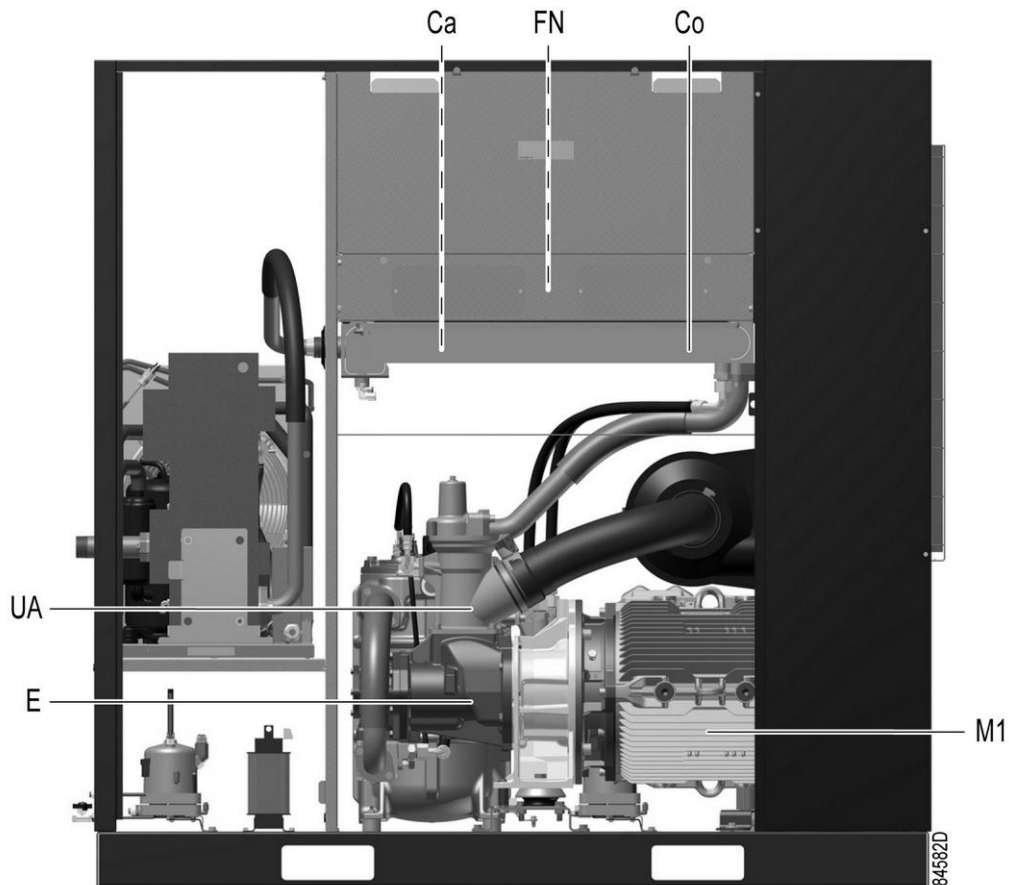

Rear view, compressors with integrated dryer

References

1	Electric cabinet
AV	Outlet valve
Ca	Air cooler
Co	Oil cooler
E	Compressor element
ER	Airlogic ² controller
FN	Cooling fan
M1	Motor of the compressor
S3	Emergency stop button
UA	Unloader
Da (Dm)	Condensate outlets
AF	Air filter
AR	Air receiver (oil separator tank)
OF	Oil filter
DR	Dryer (only on units with integrated dryer)

2.2 Air and oil circuit

Air circuit

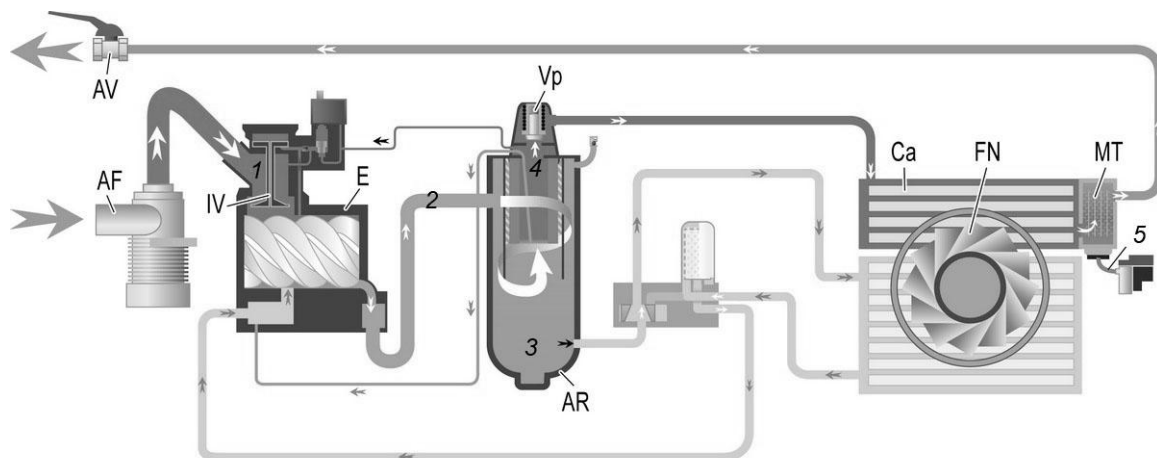

- | | | | |
|---|-------------------|---|----------------------|
| 1 | ■ Intake air | 4 | ■ Wet compressed air |
| 2 | ■ Air/oil mixture | 5 | ■ Condensate |
| 3 | ■ Oil | | |

Flow diagram, air circuit (compressors without integrated dryer)

84546D

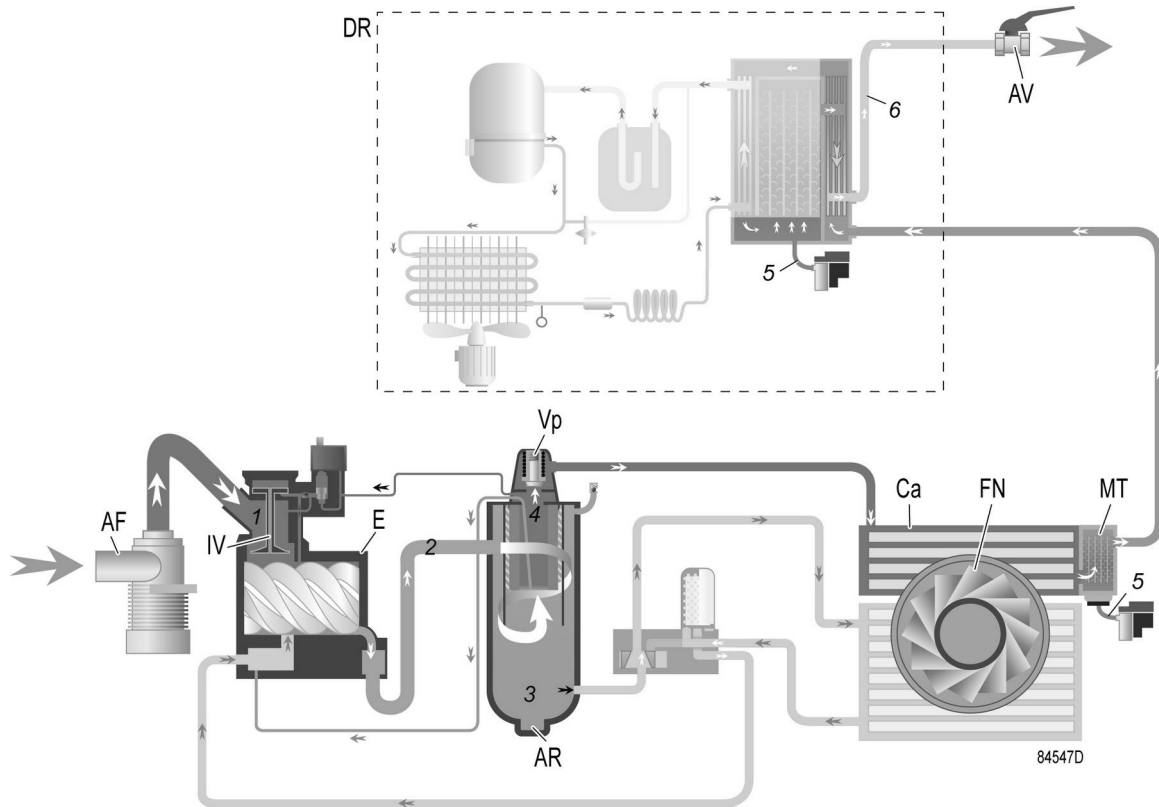

- 1 ■ Intake air
- 2 ■ Air/oil mixture
- 3 ■ Oil
- 4 ■ Wet compressed air
- 5 ■ Condensate
- 6 ■ Dried compressed air

Flow diagram, air circuit (compressors with integrated dryer)

Reference	Description
1	Intake air
2	Air/oil mixture
3	Oil
4	Wet compressed air
5	Condensate
6	Dried compressed air

Description

Air drawn through inlet filter (AF) and open inlet valve (IV) of the unloader is compressed in compressor element (E). A mixture of compressed air and oil flows into the air receiver/oil separator tank (AR). The air is discharged through outlet valve (AV) via minimum pressure valve (Vp) and air cooler (Ca).

The air cooler is provided with a moisture trap (MT).

On compressors with integrated dryer, the air flows through air dryer (DR) before it is discharged through outlet valve (AV). Also see section [Air dryer](#).

Under all circumstances, the minimum pressure valve (Vp) keeps the pressure in the separator tank (AR) above the minimum value that is required for lubrication of the compressor element. An integrated check valve prevents the compressed air downstream the minimum pressure valve from being vented to atmosphere during unloaded operation. When the compressor is stopped, inlet valve (IV) closes, preventing compressed air (and oil) to be vented into the air filter.

Oil circuit

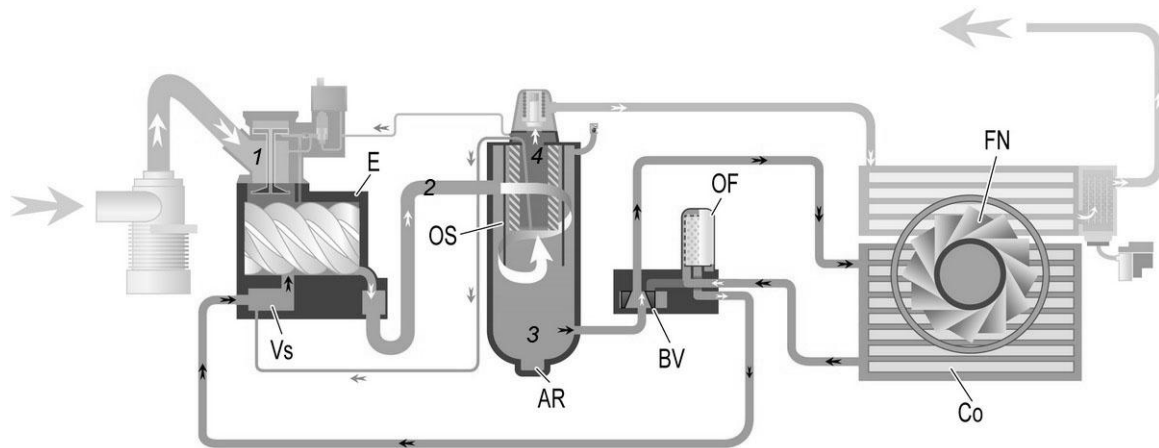

- 1 ■ Intake air
- 2 ■ Air/oil mixture
- 3 ■ Oil
- 4 ■ Wet compressed air

84548D

Flow diagram, oil circuit

Reference	Description
1	Intake air
2	Air/oil mixture
3	Oil
4	Wet compressed air

Description

Air pressure in the separator tank forces the oil via oil filter (OF) to compressor element (E), where it acts as sealant, coolant, lubricant and corrosion inhibitive (during stand still periods).

In air receiver/oil separator tank (AR), most of the oil is separated from the air/oil mixture by gravity and inertia. The remaining oil is separated by oil separator (OS). The oil collects in the lower part of air receiver/oil separator (AR).

The oil circuit is provided with a thermostatic bypass valve (BV). When the oil temperature is below its setpoint, the oil cooler is bypassed. Bypass valve (BV) starts opening the supply to cooler (Co) when the oil temperature has increased to the setpoint temperature. At approx. 15 °C (27 °F) above the setpoint temperature, all the oil flows through the oil cooler.

A tropical thermostatic valve (available as an option) offers a higher opening temperature, it helps avoiding condensate accumulation in the oil. This option is advised when the compressor operates in high humidity conditions.

2.3 Cooling system

Air-cooled

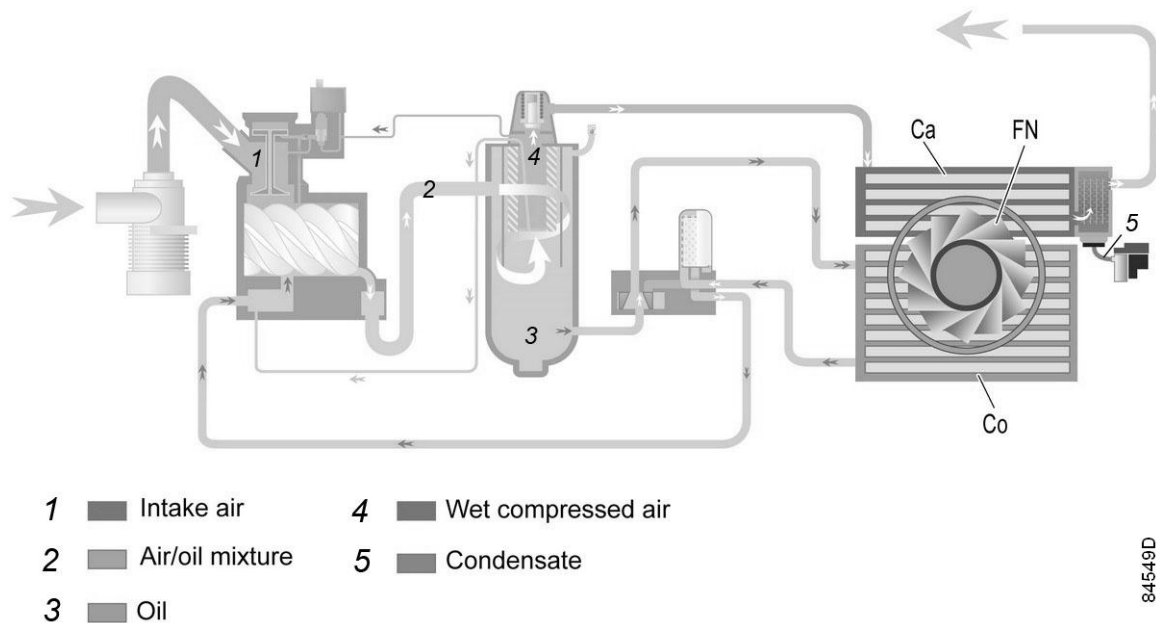

84549D

Cooling system, air-cooled compressors

Reference	Description
1	Intake air
2	Air/oil mixture
3	Oil
4	Wet compressed air
5	Condensate

Description

The cooling system on air-cooled compressors comprises air cooler (Ca) and oil cooler (Co). The cooling air flow is generated by fan (FN).

2.4 Condensate system

The condensate, collected in the moisture trap of the air cooler, is evacuated via an automatic drain. A compressor with integrated dryer has an additional drain on the moisture trap of the dryer. Each drain is connected to its outlet connection (Da) and a manual drain valve (Dm).

Mechanical drains

The compressors have a mechanical condensate drain (MWD) as standard.

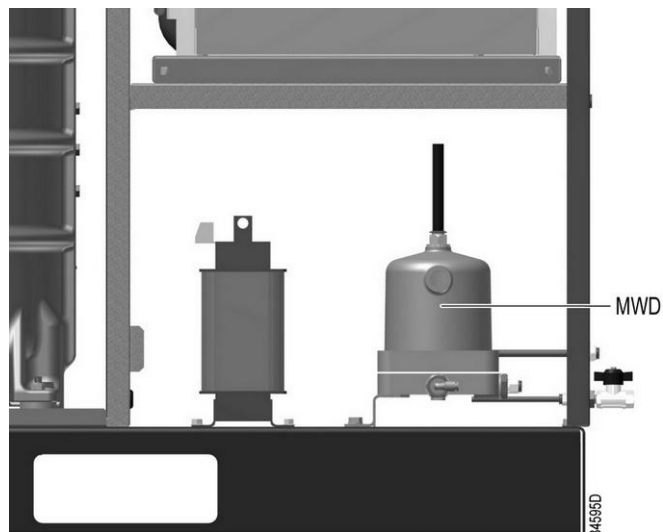

Mechanical condensate drain

A float opens or closes the outlet dependant on the level of the condensate in the bowl.

Drain connections

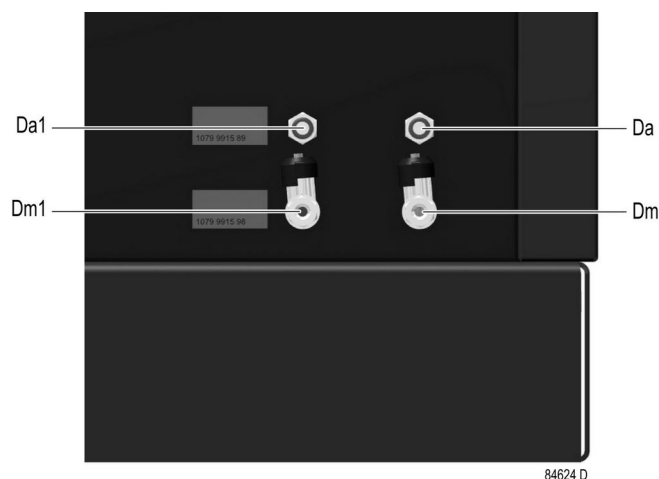

Condensate drain connections

Reference	Designation
Da	Automatic drain connection
Dm	Manual drain valve
Da1	Automatic drain connection of the dryer (only on units with integrated dryer)
Dm1	Manual drain valve of the dryer (only on units with integrated dryer)

2.5 Regulating system

Load/unload regulating system

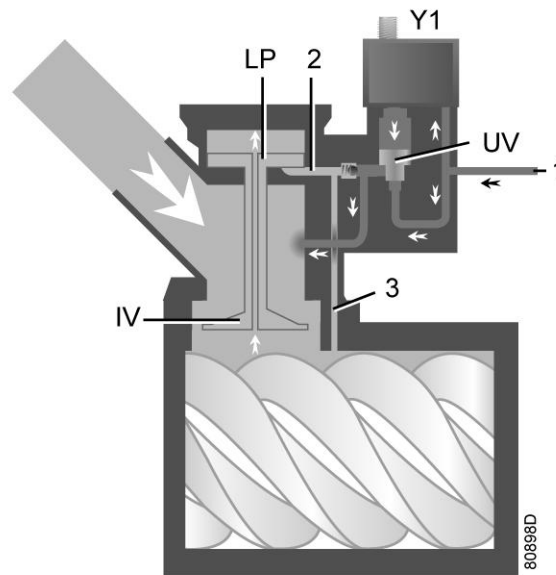

Regulating system (loaded condition)

Loading

When the net pressure is below the loading pressure, solenoid valve (Y1) is energised. Results:

- The space above unloading valve/blow-off valve (UV) is connected with the oil separator tank pressure (1) via the solenoid valve.
- Unloading valve/blow-off valve (UV) moves downwards, closing off the connection to channels (2) and (3).
- Underpressure from the compressor element causes loading plunger (LP) to move downwards and inlet valve (IV) to open fully.

Air delivery is 100%, the compressor runs loaded.

Unloading

If the air consumption is less than the air output of the compressor, the net pressure increases. When the net pressure reaches the unloading pressure, solenoid valve (Y1) is de-energised.

Results:

- The pressure above unloading valve/blow-off valve (UV) is released to atmosphere and the space above valve (UV) is no longer in connection with the oil separator tank pressure (1).
- Unloading valve/blow-off valve (UV) moves upwards, connecting the oil separator tank pressure (1) with channels (2) and (3).
- The pressure in channel (2) causes the loading plunger (LP) to move upwards, causing inlet valve (IV) to close, while the pressure is gradually released to atmosphere.
- The pressure in the separator tank stabilises at low value. A small amount of air is kept drawn in to guarantee a minimal pressure, required for lubrication during unloaded operation.

Air output is stopped, the compressor runs unloaded.

2.6 Electrical system

Electrical components

The electrical system is comprised of the following components:

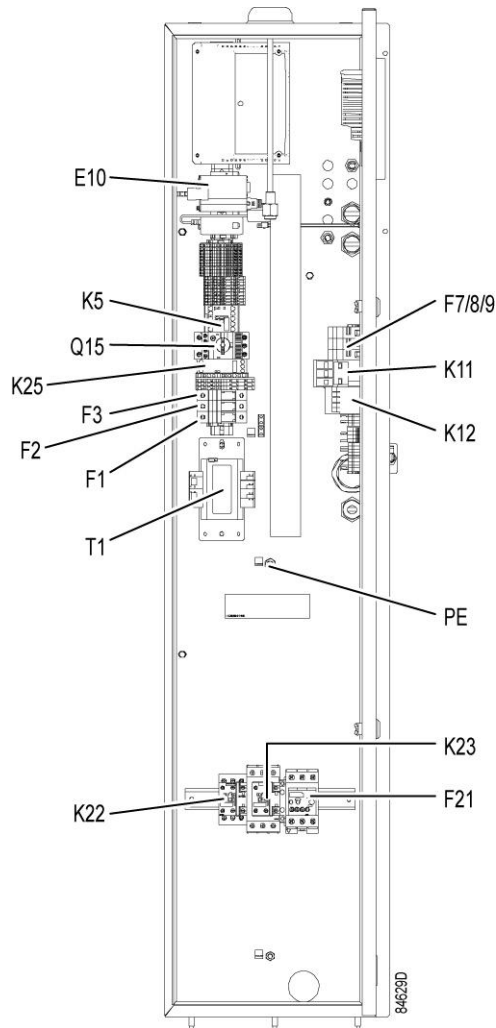

Typical example of electric cubicle

Reference	Designation
F1	Fuse
F2	Fuse
F3	Fuse
F7/8/9	Fuses (only on units with integrated dryer)
F21	Overload relay, compressor motor
Q15	Circuit breaker, fan motor (on air-cooled compressors)
K5	Auxiliary relay

Reference	Designation
K11	Auxiliary contactor (only on units with integrated dryer)
K12	Auxiliary contactor (only on units with integrated dryer)
K25	Phase sequence relay
K22	Star contactor
K23	Delta contactor
T1	Transformer
PE	Earth terminal

Electrical diagram

9828 5102 02	Service diagram
--------------	-----------------

The complete electrical diagram can be found in the electric cubicle and in the technical documentation, supplied with the machine.

2.7 Air dryer

(On compressors with integrated dryer only)

Flow diagram

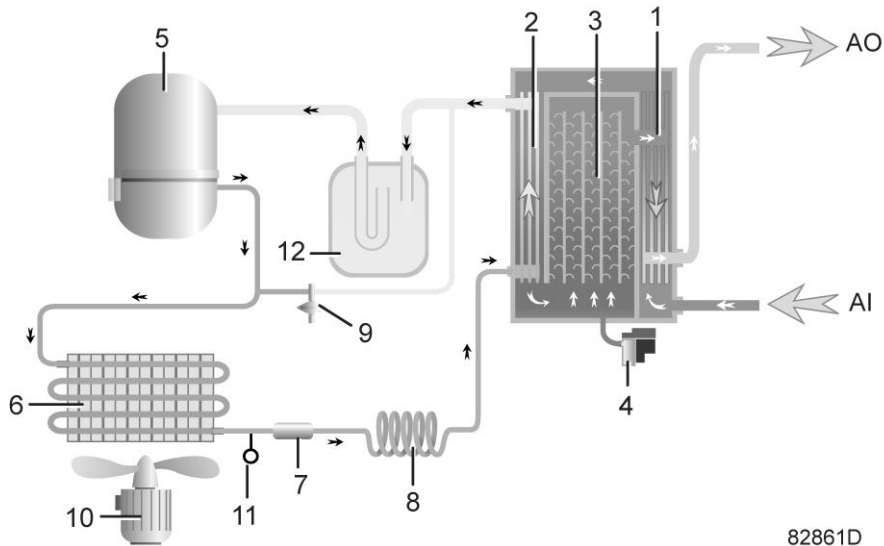

82861D

Air dryer

Reference	Name
AI	Air inlet
AO	Air outlet
1	Air/air heat exchanger

Reference	Name
2	Air/refrigerant heat exchanger/evaporator
3	Condensate separator
4	Automatic drain / condensate outlet
5	Refrigerant compressor
6	Refrigerant condenser
7	Liquid refrigerant dryer/filter
8	Capillary
9	Bypass valve
10	Condenser cooling fan
11	Pressure switch, fan control
12	Liquid separator

Compressed air circuit

Compressed air enters heat exchanger (1) and is cooled by the outgoing, cold, dried air. Water in the incoming air starts to condense. The air then flows through heat exchanger/evaporator (2), where the refrigerant evaporates, causing the air to be cooled further to close to the evaporating temperature of the refrigerant. More water in the air condenses. The cold air then flows through separator (3) where all the condensate is separated from the air. The condensate is automatically drained through condensate drain (4).

The cold, dried air flows through heat exchanger (1) where it is warmed up by the incoming air.

Refrigerant circuit

Compressor (5) delivers hot, high-pressure refrigerant gas which flows through condenser (6) where most of the refrigerant condenses.

The liquid refrigerant flows through liquid refrigerant dryer/filter (7) to capillary tube (8). The refrigerant leaves the capillary tube at about evaporating pressure.

The refrigerant enters evaporator (2) where it withdraws heat from the compressed air by further evaporation at about constant pressure. The heated refrigerant leaves the evaporator and is sucked in by the compressor (5) through a liquid separator (12).

Bypass valve (9) regulates the refrigerant flow. Fan (10) is switched on or off by switch (11) depending on the pressure degree of the condensate.

3 Graphic controller

3.1 Controller



View of the AIRLOGIC² controller

Introduction

The electronic controller has following functions:

- Controlling the compressor
- Protecting the compressor
- Monitoring components subject to service
- Automatic restart after voltage failure

Automatic control of the compressor

The controller maintains the net pressure between programmable limits by automatically loading and unloading the compressor (fixed speed compressors) or by adapting the motor speed (compressors with frequency converter). A number of programmable settings, e.g. the unloading and loading pressures (for fixed speed compressors), the setpoint (for compressors with frequency converter), the minimum stop time and the maximum number of motor starts and several other parameters are taken into account.

The controller stops the compressor whenever possible to reduce the power consumption and restarts it automatically when the net pressure decreases. If the expected unloading period is too short, the compressor is kept running to prevent too short standstill periods.



A number of time based automatic start/stop commands may be programmed. Take into account that a start command will be executed (if programmed and activated), even after manually stopping the compressor.

Protecting the compressor

Shutdown

Several sensors are provided on the compressor. If one of the measured signals exceeds the programmed shutdown level, the compressor will be stopped.

Example: If the compressor element outlet temperature exceeds the programmed shutdown level, the compressor will be stopped. This will be indicated on the display of the controller.

The compressor will also be stopped in case of overload of the drive motor.

Air-cooled compressors will also be stopped in the event of overload of the fan motor.

	Before remedying, consult the Safety precautions .
---	--

Shutdown warning

A shutdown warning level is a programmable level below the shutdown level.

If one of the measurements exceeds the programmed shutdown warning level, this will also be indicated to warn the operator before the shutdown level is reached.

The message disappears as soon as the warning condition disappears.

A warning will also appear if the dew point temperature is too high (on compressors with integrated dryer).

Service warning

A number of service operations are grouped (called Service Plans). Each Service Plan has a programmed time interval. If the service timer exceeds a programmed value, this will be indicated on the display to warn the operator to carry out the service actions belonging to that Service Plan.

Automatic restart after voltage failure

The controller has a built-in function to automatically restart the compressor when the voltage is restored after voltage failure. For compressors leaving the factory, this function is made inactive. If desired, the function can be activated. Consult your local supplier.

	<p>If the function is activated and provided the regulator was in the automatic operation mode, the compressor will automatically restart if the supply voltage to the module is restored.</p> <p>The ARAVF label (see section Pictographs) shall be glued near to the controller.</p>
---	--

3.2 Control panel

Detailed description

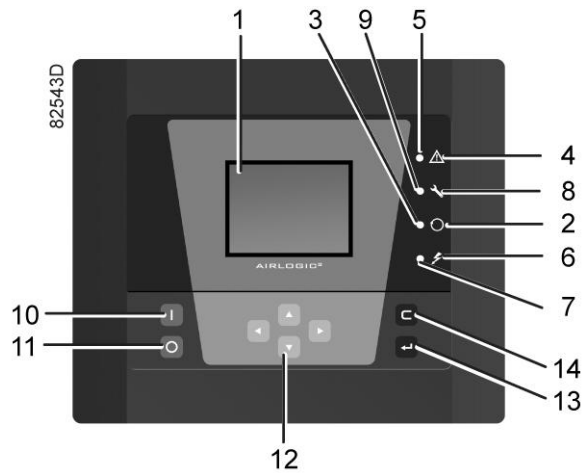



















Function keys of the controller

Reference	Designation	Function
1	Display	Shows icons and operating conditions.
2	Automatic operation symbol	
3	LED, Automatic operation	Indicates that the regulator is automatically controlling the compressor: the compressor is loaded, unloaded, stopped and restarted depending on the air consumption and the limitations programmed in the regulator.
4	Warning symbol	
5	LED, Warning	Flashes in case of a shutdown, is lit in case of a warning condition.
6	Voltage symbol	
7	LED, Voltage on	Indicates that the voltage is switched on.
8	Service symbol	
9	LED, Service	Is lit when service is needed.
10	Start button	This button starts the compressor. Automatic operation LED (3) lights up. The controller is operative.
11	Stop button	This button is used to stop the compressor. Automatic operation LED (3) goes out.
12	Scroll buttons	Use these buttons to scroll through the menu.
13	Enter button	Use this button to confirm the last action.
14	Escape button	Use this button to go to previous screen or to end the current action.





3.3 Icons used

Status icons











Name	Icon	Description
Stopped / Running	 57786F	When the compressor is stopped, the icon stands still. When the compressor is running, the icon is rotating.
Compressor status	 57787F	Motor stopped
	 57788F	Running unloaded
	 57789F	Running loaded
Machine control mode	 57790F or  59161F	Local start / stop
	 57791F	Remote start / stop
	 57792F	Network control
	 57793F	Automatic restart after voltage failure is active
Week timer	 57794F	Week timer is active

Name	Icon	Description
Active protection functions	 57795F	Emergency stop
	 57796F	Shutdown
	 57797F	Warning
Service	 57798F	Service required
Main screen display	 59162F	Value lines display icon
	 82196F	Chart display icon
General icons	 81105D	No communication / network problem
	 82418D	Not valid

Input icons









Icon	Description
 57799F	Pressure
 57800F	Temperature
 57801F	Digital input
 57802F	Special protection

System icons



Icon	Description
 57803F	Compressor element (LP, HP, ...)
 57804F	Dryer
 57805F	Fan
 57806F	Frequency converter
 57807F	Drain
 57808F	Filter
 57809F	Motor
 57810F	Failure expansion module
 81105D	Network problem
 57812F	General alarm

Menu icons

Icon	Description
 57813F	Inputs
 57814F	Outputs
 57812F	Protections (Warnings, shutdowns)
 57815F	Counters
 82641D	Test
 57817F	Regulation (Settings)

Icon	Description
 57798F	Service
 57818F	Event history (saved data)
 57819F	Access key / User password
 57792F	Network
 57820F	Setpoint
 57867F	Information
 57794F	Week Timer
 82633D	General

Navigation arrows

Icon	Description
 57821F	Up
 57822F	Down

3.4 Main screen

Function

The Main screen is the screen that is shown automatically when the voltage is switched on and one of the keys is pushed. It is switched off automatically after a few minutes when no keys are pushed.

Typically, 5 different main screen views can be chosen:

1. Two value lines
2. Four value lines
3. Chart (High resolution)
4. Chart (Medium resolution)
5. Chart (Low resolution)

Two and four value lines screens

This type of Main screen shows the value of 2 or 4 parameters (see section [Inputs menu](#)).



Typical Main screen (2 value lines), fixed speed compressors



Typical Main screen (2 value lines), compressors with frequency converter

Text on figures

(1)	Compressor Outlet
(2)	Element Outlet (fixed speed compressors) Flow (compressors with frequency converter)
(3)	Load, shutdown, ... (text varies upon the compressors actual condition)
(4)	Menu

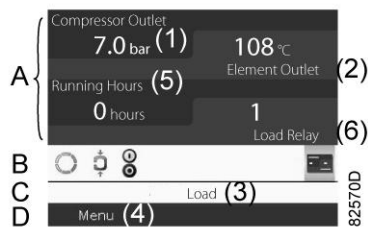

Typical Main screen (4 value lines), fixed speed compressors



Typical Main screen (4 value lines), compressors with frequency converter

Text on figures

(1)	Compressor Outlet
(2)	Element outlet
(3)	Load, ... (text varies upon the compressors actual condition)
(4)	Menu
(5)	Running hours
(6)	Load relay (one of the input signals of fixed speed compressors) Flow (compressors with frequency converter)

- **Section A** shows information regarding the compressor operation (e.g. the outlet pressure or the temperature at the compressor outlet). On compressors with a frequency converter, the load degree (flow) is given in % of the maximum flow.
- **Section B** shows Status icons. Following icon types are shown in this field:
 - Fixed icons
These icons are always shown in the main screen and cannot be selected by the cursor (e.g. Compressor stopped or Compressor running, Compressor status: running, running unloaded or motor stopped).
 - Optional icons
These icons are only shown if their corresponding function is activated (e.g. week timer, automatic restart after voltage failure , etc.)
 - Pop up icons
These icons pop up if an abnormal condition occurs (warnings, shutdowns, service,...)
 To call up more information about the icons shown, select the icon concerned using the scroll keys and press the enter key.
- **Section C** is called the Status bar
This bar shows the text that corresponds to the selected icon.
- **Section D** shows the Action buttons. These buttons are used:
 - To call up or program settings
 - To reset a motor overload, service message or emergency stop
 - To have access to all data collected by the regulator
 The function of the buttons depends on the displayed menu. The most common functions are:

Designation	Function
Menu	To go to the menu
Modify	To modify programmable settings
Reset	To reset a timer or message

To activate an action button, highlight the button by using the Scroll keys and press the Enter key.
To go back to the previous menu, press the Escape key.

Chart views

Instead of viewing values, it is also possible to view a graph of one of the input signals (see section [Inputs menu](#)) in function of the time.

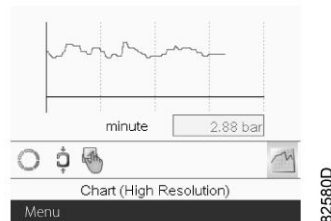

When Chart (High Resolution) is selected, the chart shows the variation of the selected input (in this case the pressure) per minute. Also the instantaneous value is displayed. The screen shows the last 4 minutes.

The switch button (icon) for selecting other screens is changed into a small Chart and is highlighted (active).

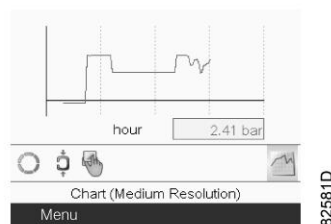

When the Chart (Medium Resolution) is selected, the chart shows the variation of the selected input per hour. The screen shows the last 4 hours.

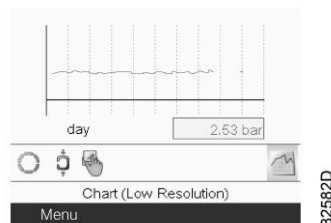

When the Chart (Low Resolution) is selected, the chart shows the variation of the selected input per day. The screen shows the evolution over the last 10 days.

Selection of a main screen view

To change between the different screen layouts, select the far right icon in the control icons line (see value lines display icon or chart display icon in section [Used icons](#)) and press the Enter key. A screen similar to the one below opens:

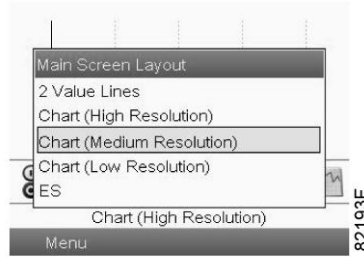

Select the layout required and press the Enter key. See also section [Inputs menu](#).

3.5 Calling up menus

Description

When the voltage is switched on, the main screen is shown automatically:

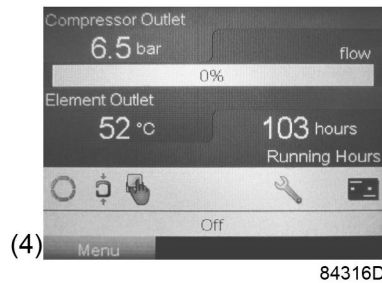

- To go to the Menu screen, highlight the Menu button (4), using the Scroll keys.
- Press the Enter key to select the menu. Following screen appears:

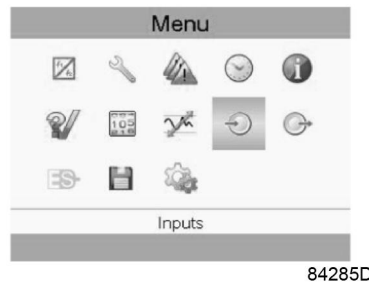

- The screen shows a number of icons. Each icon indicates a menu item. By default, the Pressure Settings (Regulation) icon is selected. The status bar shows the name of the menu that corresponds with the selected icon.
- Use the Scroll keys to select an icon.
- Press the Escape key to return to the Main screen.

3.6 Inputs menu

Menu icon, Inputs



Function

- To display the actual value of the measured data (analog inputs) and the status of the digital inputs (e.g. emergency stop contact, motor overload relay, etc.).
- To select the digital input to be shown on the chart in the main screen.

Procedure

Starting from the main screen,

- Move the cursor to the action button Menu and press the Enter key.
- Using the Scroll keys, move the cursor to the Inputs icon, as shown in the following screen:

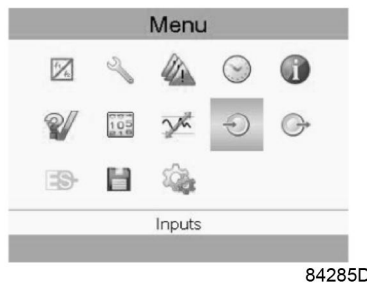

84285D

- Press the Enter key. A screen similar to the one below appears:

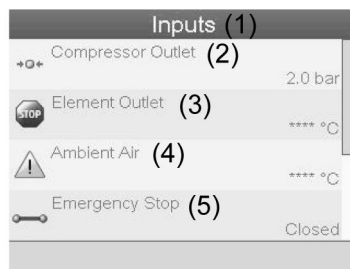

57831F

Text on image

(1)	Inputs
(2)	Compressor outlet
(3)	Element outlet
(4)	Ambient air
(5)	Emergency stop

- The screen shows a list of all inputs with their corresponding icons and readings.
- If an input is in warning or shutdown, the original icon is replaced by the warning or shutdown icon respectively (i.c. the Stop icon and the Warning icon in the screen shown above).

A small chart icon, shown below an item in the list means this input signal is shown on the chart at the main screen. Any analog input can be selected.

Selecting another input signal as main chart signal

With the Modify button active (light grey background in above screen), press the Enter button on the controller. A screen similar to the one below appears:



The first item in the list is highlighted. In this example, the Net Pressure is selected (chart icon). To change, press the Enter button again: a pop-up window opens:

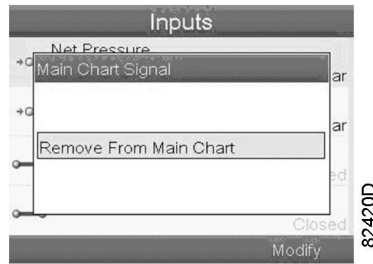

Press Enter again to remove this input from the chart. Another confirmation pop-up opens:

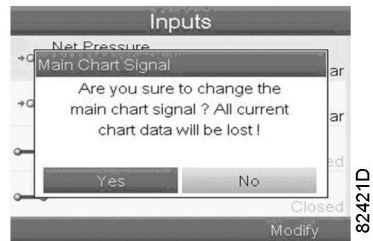

Select Yes to remove or No to quit the current action.

In a similar way, another input signal can be highlighted and selected as Main Chart signal:

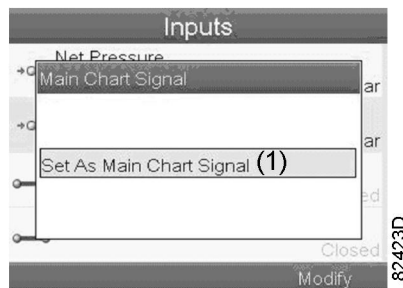
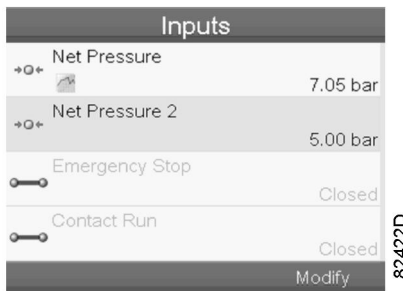

(1): Set as main chart signal

3.7 Outputs menu

Menu icon, Outputs



Function

To call up information regarding the actual status of some outputs such as the condition of the Fan overload contact (on air cooled compressors), the Emergency stop contact, etc.

Procedure

Starting from the Main screen,

- Move the cursor to the action button Menu and press the Enter key.
- Move the cursor to the Outputs icon (see below).

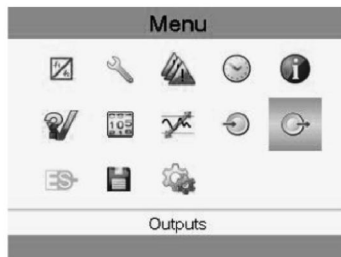

84286D

- Press the Enter key. A screen similar to the one below appears:

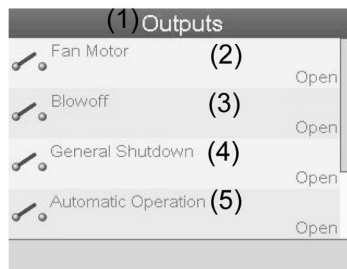

81484D

Outputs screen (typical)

Text on image

(1)	Outputs
(2)	Fan motor contact
(3)	Blow-off contact
(4)	General shutdown
(5)	Automatic operation

- The screen shows a list of all outputs with their corresponding icons and readings. If an output is in warning or shutdown, the original icon is replaced by the warning or shutdown icon respectively.

3.8 Counters

Menu icon, Counters



Function

To call up:

- The running hours
- The loaded hours
- The number of motor starts
- The number of hours that the regulator has been powered
- The number of load cycles

Procedure

Starting from the Main screen,

- Move the cursor to the action button Menu and press the Enter key.
- Using the Scroll keys, move the cursor to the Counters icon (see below)



84287D

- Press the Enter key. A screen similar to the one below appears:



Text on image

(1)	Counters
(2)	Running hours
(3)	Motor starts
(4)	Load relay
(5)	VSD 1-20 % rpm in % (the percentage of the time during which the motor speed was between 1 and 20 %) (compressors with frequency converter)

The screen shows a list of all counters with their actual readings.

Note: the example above is for a frequency converter driven compressor. For a fixed speed compressor, the actual screen will be somewhat different.

3.9 Control mode selection

Function

To select the control mode, i.e. whether the compressor is in local control, remote control or controlled via a local area network (LAN).

Procedure

Starting from the main screen, make sure the action button Menu (1) is selected:

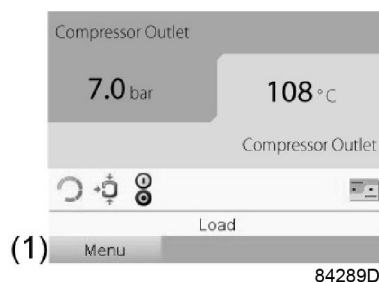

Next, use the scroll buttons to go to the Status icons (see section Main screen) and select the machine control icon (2).

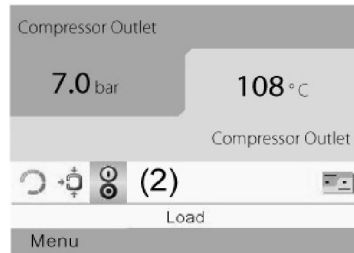

84288D

Press the enter button.

There are 3 possibilities:

- Local control
- Remote control
- LAN (network) control

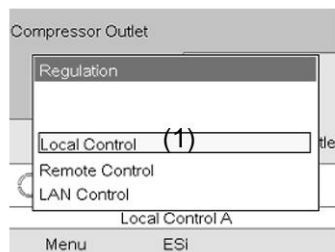

82024F

After selecting the required regulation mode, press the enter button on the controller to confirm your selection. The new setting is now visible on the main screen. See section [Used icons](#) for the meaning of the icons.

3.10 Service menu

Menu icon, Service



Function

- To reset the service plans which are carried out.
- To check when the next service plans are to be carried out.
- To find out which service plans were carried out in the past.
- To modify the programmed service intervals.

Procedure

Starting from the Main screen,

- Move the cursor to the action button Menu and press the Enter key.
- Using the Scroll keys, move the cursor to the Service icon (see below).



84290D

- Press the Enter key. Following screen appears:

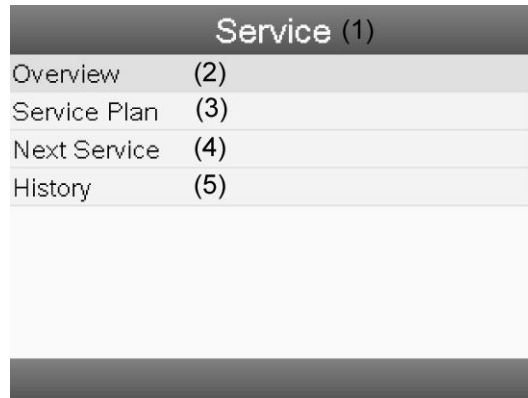

57847F_1

Text on image

(1)	Service
(2)	Overview
(3)	Service plan
(4)	Next service
(5)	History

- Scroll through the items to select the desired item and press the Enter key to see the details as explained below.

Overview

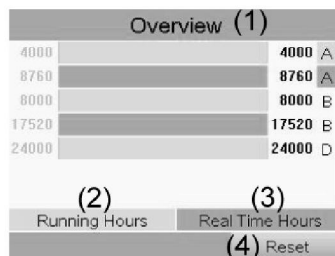

84291D

Text on image

(1)	Overview
(2)	Running Hours
(3)	Real Time hours
(4)	Reset

Example for service level (A):

The figures at the left are the programmed service intervals. For Service interval A, the programmed number of running hours is 4000 hours (upper row) and the programmed number of real time hours is 8760 hours, which corresponds to one year (second row). This means that the controller will launch a service warning when either 4000 running hours or 8760 real hours are reached, whichever comes first. Note that the real time hours counter keeps counting, also when the controller is not powered.

The figures at the end of the bars are the number of hours to go till the next service intervention. In the example above, the compressor was just started up, which means it still has 4000 running hours and 8299 hours to go before the next Service intervention.

Service plans

A number of service operations are grouped (called Level A, Level B, etc...). Each level stands for a number of service actions to be carried out at the time intervals programmed in the controller.

When a service plan interval is reached, a message will appear on the screen.

After carrying out the service actions related to the indicated levels, the timers must be reset.

From the Service menu above, select Service plan (3) and press Enter. Following screen appears:

Service Plan (1)		
(2) Level	(3) Running Hours	(4) Real Time
A	4000	8760
B	8000	17520
C		
D	24000	
E	32000	
		(5) Modify

57849F

Text on image

(1)	Service plan
(2)	Level
(3)	Running hours
(4)	Real time hours
(5)	Modify

Modifying a service plan

Dependant on the operating conditions, it can be necessary to modify the service intervals. To do so, use the Scroll keys to select the value to be modified. A screen similar to the one below appears:

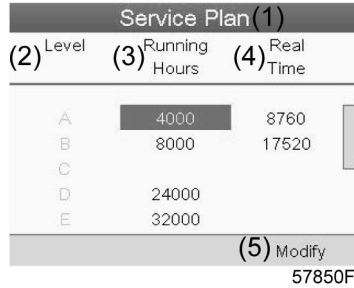

Press the Enter key. Following screen appears:

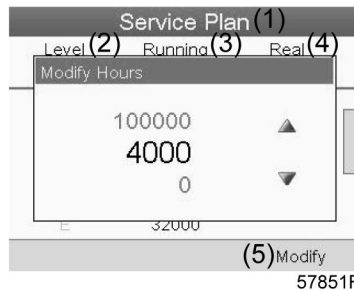

Modify the value as required using the ↑ or ↓ scroll key and press the Enter key to confirm.

Note: Running hours can be modified in steps of 100 hours, real time hours can be modified in steps of 1 hour.

Next Service

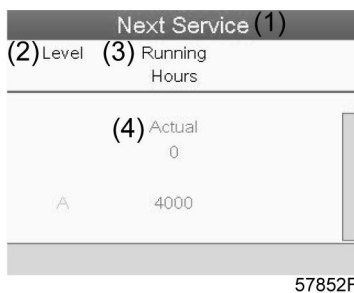

Text on image

(1)	Next service
(2)	Level
(3)	Running hours
(4)	Actual

In the example above, the A Service level is programmed at 4000 running hours, of which 0 hours have passed.

History

The History screen shows a list of all service actions done in the past, sorted by date. The date at the top is the most recent service action. To see the details of a completed service action (e.g. Service level, Running hours or Real time hours), use the Scroll keys to select the desired action and press the Enter key.

3.11 Regulation menu

Menu icon, Setpoint



Function

On fixed speed compressors, the operator can program two different pressure bands. This menu is also used to select the active pressure band.

Procedure

Starting from the Main screen (see [Main screen](#)),

- Move the cursor to the action button Menu and press the Enter key.
- Using the Scroll keys, move the cursor to the Setpoint icon (see below).

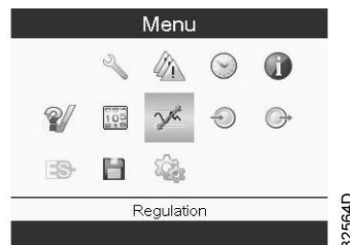

- Press the Enter key. Following screen appears:

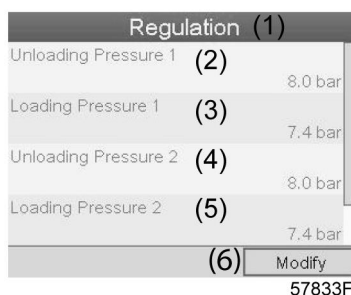

Text on figure

(1)	Regulation
(2)	Unloading pressure 1

(3)	Loading pressure 1
(4)	Unloading pressure 2
(5)	Loading pressure 2
(6)	Modify

- The screen shows the actual unloading and loading pressure settings for both pressure bands.
To modify the settings, move the cursor to the action button Modify and press the Enter key.
Following screen appears:

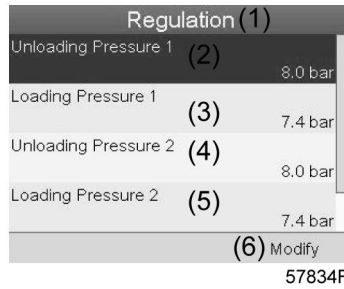

- The first line of the screen is highlighted. Use the Scroll keys to highlight the setting to be modified and press the Enter key. Following screen appears:

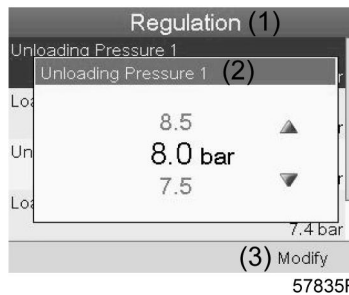

- The upper and lower limit of the setting is shown in grey, the actual setting is shown in black.
Use the ↑ or ↓ key of the Scroll keys to modify the settings as required and press the Enter key to accept.

If necessary, change the other settings as required in the same way as described above.

3.12 Event history menu

Menu icon, Event History



Function

To call up the last shut-down and last emergency stop data.

Procedure

Starting from the Main screen,

- Move the cursor to the action button Menu and press the Enter key.
- Using the Scroll keys, move the cursor to the Event History icon (see below).



84293D

- Press the Enter key.
The list of last shut-down and emergency stop cases is shown.



82617D

Example of Event History screen

- Scroll through the items to select the desired shut-down or emergency stop event.
- Press the Enter key to find the date, time and other data reflecting the status of the compressor when that shut-down or emergency stop occurred.

3.13 Modifying general settings

Menu icon, Settings



Function

To display and modify a number of settings.

Procedure

Starting from the Main screen,

- Move the cursor to the action button Menu and press the Enter key.
- Using the Scroll keys, move the cursor to the Settings icon (see below).



84294D

- Press the Enter key. A second menu screen appears:



84295D

This screen shows again a number of icons. By default, the User Password icon is selected. The status bar shows the description that corresponds with the selected icon. Each icon covers one or more items (depending on the configuration), such as

- Access level
- Elements
- Dryer
- Fan
- Converter(s)
- Filter(s)
- Motor/Starter
- General
- Automatic restart after voltage failure (ARAVF)
- Network
- Regulation
- Remote

For adapting certain parameters, a password may be necessary.

Example: Selecting the General Settings icon gives the possibility to change e.g. the language, the date, the date format, etc.:

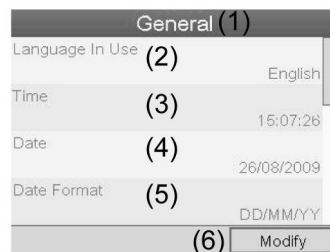

57840F

Text on image

(1)	General
(2)	Language used
(3)	Time

(4)	Date
(5)	Date format
(6)	Modify

- To modify, select the Modify button using the Scroll keys and press the Enter key.
- A screen similar to the one above is shown, the first item (Language) is highlighted. Use the ↓ key of the Scroll keys to select the setting to be modified and press the Enter key.
- A pop-up screen appears. Use the ↑ or ↓ key to select the required value and press the Enter key to confirm.

3.14 Week timer menu

Menu icon, Week timer



Function

- To program time-based start/stop commands for the compressor
- To program time-based change-over commands for the net pressure band
- Four different week schemes can be programmed.
- A week cycle can be programmed, a week cycle is a sequence of 10 weeks. For each week in the cycle, one of the four programmed week schemes can be chosen.
- In the controller you can select different timers on one day (up to 8 actions). It is however not possible to program 2 actions at the same time. The solution: leave at least 1 minute in between 2 actions.

Example: Start Compressor: 5.00 AM, Pressure Setpoint 2: 5.01 AM (or later).

Procedure

Starting from the Main screen,

- Move the cursor to the action button Menu and press the Enter key.
- Use the Scroll buttons to select the Timer icon. (see below)

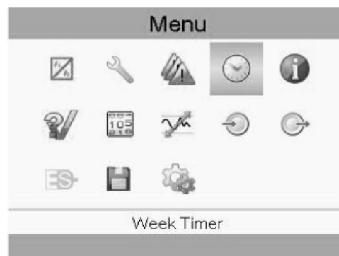

84296D

- Press the Enter key. Following screen appears:

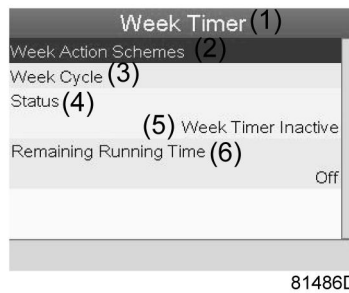

Text on image

(1)	Week Timer
(2)	Week Action Schemes
(3)	Week Cycle
(4)	Status
(5)	Week Timer Inactive
(6)	Remaining Running Time

The first item in this list is highlighted. Select the item requested and press the Enter key on the controller to modify.

Programming week schemes

- Select Week action schemes and press Enter. A new window opens. The first item in the list is highlighted in red. Press the Enter key on the controller to modify Week Action Scheme 1.

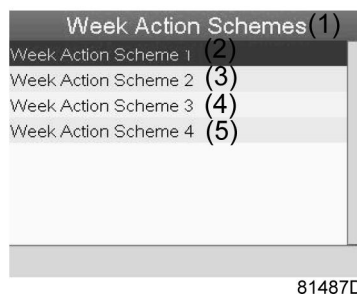

(1)	Week Action Schemes
(2)	Week Action Scheme 1
(3)	Week Action Scheme 2
(4)	Week Action Scheme 3
(5)	Week Action Scheme 4

- A weekly list is shown. Monday is automatically selected and highlighted in red. Press the Enter key on the controller to set an action for this day.

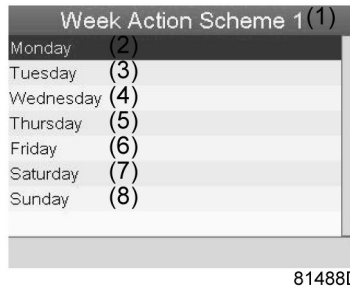

(1)	Week Action Scheme 1
(2)	Monday
(3)	Tuesday
(4)	Wednesday
(5)	Thursday
(6)	Friday
(7)	Saturday
(8)	Sunday

- A new window opens. The Modify action button is selected. Press the enter button on the controller to create an action.

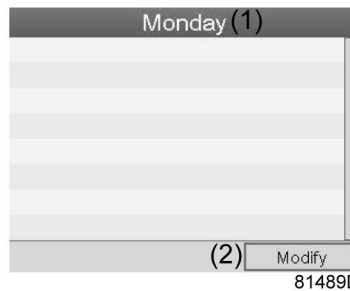

(1)	Monday
(2)	Modify

- A new pop-up window opens. Select an action from this list by using the Scroll keys on the controller. When ready press the Enter key to confirm.

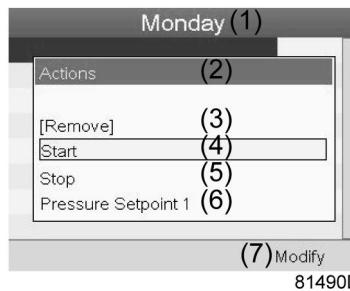

(1)	Monday
(2)	Actions

(3)	Remove
(4)	Start
(5)	Stop
(6)	Pressure Setpoint 1
(7)	Modify

- A new window opens. The action is now visible in the first day of the week.

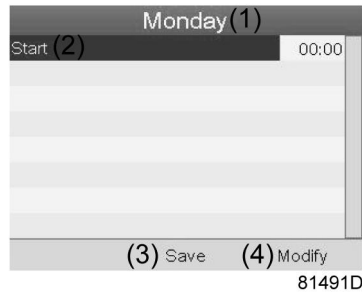

(1)	Monday
(2)	Start
(3)	Save
(4)	Modify

- To adjust the time, use the Scroll keys on the controller and press the Enter key to confirm.

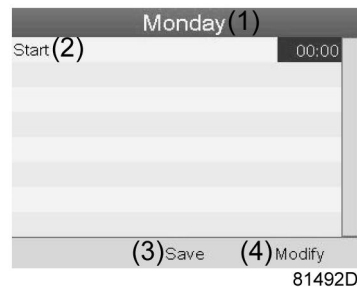

(1)	Monday
(2)	Start
(3)	Save
(4)	Modify

- A pop-up window opens. Use the ↑ or ↓ key of Scroll keys to modify the values of the hours. Use the ← or → Scroll keys to modify the minutes.

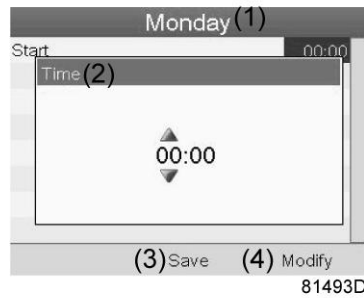

(1)	Monday
(2)	Time
(3)	Save
(4)	Modify

- Press the Escape key on the controller. The action button Modify is selected. Use the Scroll keys to select the action Save.

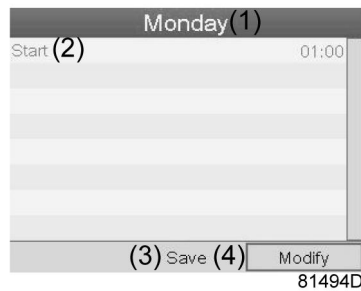

(1)	Monday
(2)	Start
(3)	Save
(4)	Modify

- A new pop-up window opens. Use the Scroll keys on the controller to select the correct actions. Press the Enter key to confirm.

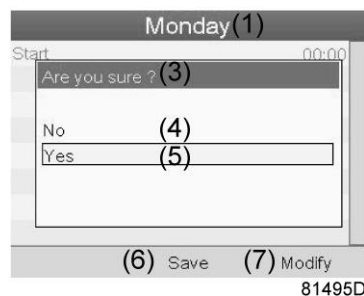

(1)	Monday
(3)	Are you sure?
(4)	No

(5)	Yes
(6)	Save
(7)	Modify

Press the Escape key to leave this window.

- The action is shown below the day the action is planned.

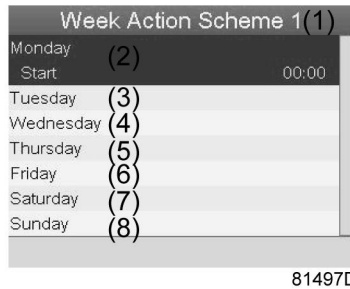

(1)	Week Action Scheme 1
(2)	Monday - Start
(3)	Tuesday
(4)	Wednesday
(5)	Thursday
(6)	Friday
(7)	Saturday
(8)	Sunday

Press the Escape key on the controller to leave this screen.

Programming the week cycle

A week cycle is a sequence of 10 weeks. For each week in the cycle, one of the four programmed week schemes can be chosen.

- Select Week Cycle from the main Week Timer menu list.

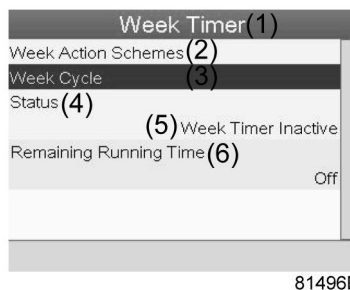

(1)	Week Timer
(2)	Week Action Schemes
(3)	Week Cycle
(4)	Status

(5)	Week Timer Inactive
(6)	Remaining Running Time

- A list of 10 weeks is shown.

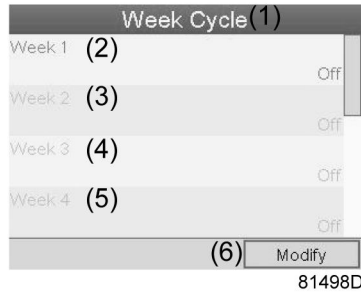

(1)	Week Cycle
(2)	Week 1
(3)	Week 2
(4)	Week 3
(5)	Week 4
(6)	Modify

Press twice the Enter key on the controller to modify the first week.

- A new window opens. Select the action, example: Week Action Scheme 1

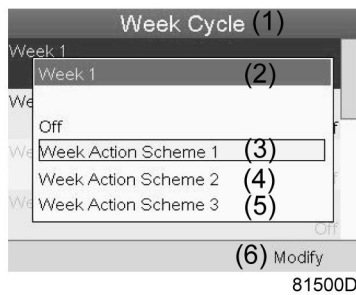

(1)	Week Cycle
(2)	Week 1
(3)	Week Action Scheme 1
(4)	Week Action Scheme 2
(5)	Week Action Scheme 3
(6)	Modify

- Check the status of the Week Timer
Use the Escape key on the controller to go back to the main Week Timer menu. Select the status of the Week Timer.

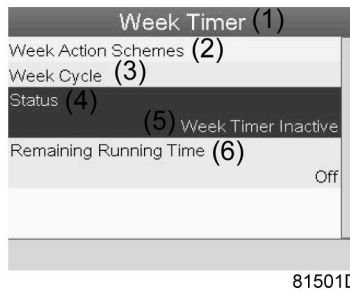

(1)	Week Timer
(2)	Week Action Schemes
(3)	Week Cycle
(4)	Status
(5)	Week Timer Inactive
(6)	Remaining Running Time

- A new window opens. Select Week 1 to set the Week Timer active.

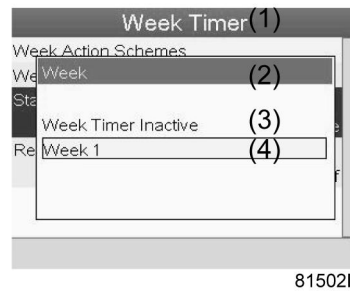

(1)	Week Timer
(2)	Week
(3)	Week Timer Inactive
(4)	Week 1

- Press the Escape key on the controller to leave this window. The status shows that week 1 is active.



(1)	Week Timer
(2)	Week Action Schemes
(3)	Week Cycle
(4)	Status
(5)	Remaining Running Time

- Press the Escape key on the controller to go to the main Week Timer menu. Select Remaining Running Time from the list and press the Enter key on the controller to Modify.



(1)	Week Timer
(2)	Week Action Schemes
(3)	Week Cycle
(4)	Status
(5)	Remaining Running Time

- This timer is used when the week timer is set and for certain reasons the compressor must continue working, for example, 1 hour, it can be set in this screen. This timer is prior to the Week Timer action.

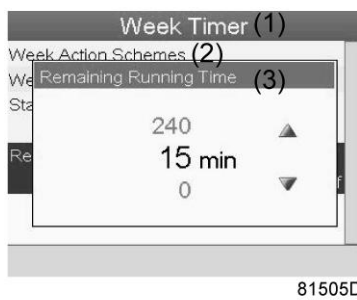

(1)	Week Timer
(2)	Week action schemes
(3)	Remaining Running Time

3.15 Test menu

Menu icon, Test



Function

- To carry out a display test, i.e. to check whether the display and LEDs are still intact.

Procedure

Starting from the Main screen,

- Move the cursor to the action button Menu and press the Enter key.
- Using the scroll keys, move the cursor to the Test icon (see below).

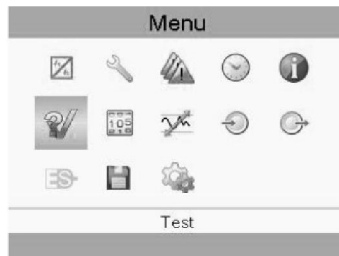

84297D

- Press the Enter key, following screen appears:

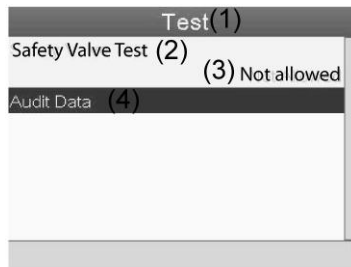

57866F

Text on image

(1)	Test
(2)	Safety Valve Test
(3)	Not allowed
(4)	Audit Date

- The safety valve test can only be performed by authorized personnel and is protected by a security code.
- Select the item display test and press the enter key. A screen is shown to inspect the display, at the same time all LED's are lit.

3.16 General menu

Menu icon, General



Function

This menu covers a list of general settings:

- Language
- Time
- Date
- Date Format
- Units

Procedure

Starting from the submenu screen (see [Modifying general settings](#)),

- Using the Scroll keys, move the cursor to the General icon (see below).

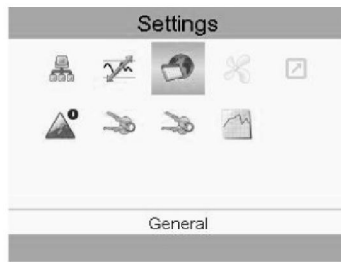

84298D

- Press the Enter key. A screen similar to the one below appears:

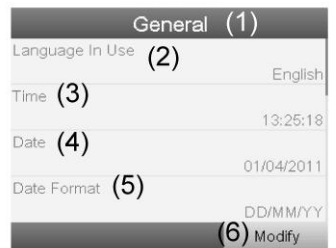

82637D

Text on figure

(1)	General
(2)	Language in use
(3)	Time
(4)	Date
(5)	Date format
(6)	Modify

- A screen similar to the one above is shown, a selection bar is covering the first item (Language). Use the ↓ key of the Scroll keys to select the setting to be modified and press the Enter key.
- To modify, select the Modify button using the Scroll keys and press the Enter key.
- A pop-up screen appears. Use the ↑ or ↓ key to select the required parameter and press the Enter key to confirm.

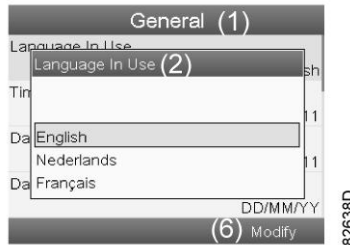

3.17 User password menu

Menu icon, Password



Function

The end customer can activate and choose a personal password. Once the password option activated, it is impossible for not authorized persons to modify any setting.

Procedure

Starting from the submenu screen (see [Modifying general settings](#)),

- Using the Scroll keys, move the cursor to the User Password icon (see below)

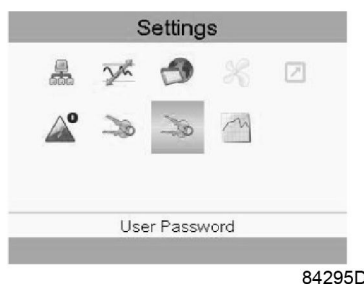

- Press the Enter key. Next screen appears.



- Select the Activate button and press the Enter key.

- Next, fill in the User Password and press the Enter key, a confirmation window opens.
- Fill in the password again and press the enter key to confirm.



Text on figure

(1)	User Password
(2)	Not activated
(3)	Activate

3.18 Access key menu

Menu icon, Access Key



Function

Only a number of basic Icons will be displayed in the Menu screen. Using the Access Key with the proper access code allows the user to see more Icons, or have access to more parameters.

Procedure

Starting from the submenu screen (see [Modifying general settings](#)),

- Using the Scroll keys, move the cursor to the Access Key icon (see below)



- Three Access levels are possible.
 - **0** : A basic set of parameters is visualized, no password is required.
 - **1** : A basic set of parameters can be modified.
 - **2** : Extra parameters will be visualized and can be modified.
- Changing the Access level can be done through the Modify button. A new pop-up window will be activated asking to enter an Access Key.



3.19 Programmable settings

Parameters: unloading/loading pressures

	Minimum setting	Factory setting	Maximum setting
Unloading/loading pressures	see Compressor data	see Compressor data	see Compressor data

Protections

		Minimum setting	Factory setting	Maximum setting
Compressor element outlet temperature (shut-down warning level)	°C	50	113	119
	°F	122	235	246
Compressor element outlet temperature (shut-down level)	°C	111	120	120
	°F	232	248	248

Service plan

The built-in service timer will give a Service warning message after a preprogrammed time interval has elapsed.

Also see section [Preventive maintenance schedule](#).

Consult your supplier if a timer setting has to be changed. The intervals must not exceed the nominal intervals and must coincide logically.

Terminology

Term	Explanation
ARAVF	Automatic restart after voltage failure.
Power recovery time	Is the period within which the voltage must be restored to have an automatic restart. Is accessible if the automatic restart is activated. To activate the automatic restart function, consult your supplier.
Restart delay	This parameter allows to programme that not all compressors are restarted at the same time after a power failure (ARAVF active).

Term	Explanation
Compressor element outlet	The regulator does not accept inconsistent settings, e.g. if the warning level is programmed at 95 °C (203 °F), the minimum limit for the shut-down level changes to 96 °C (204 °F). The recommended difference between the warning level and shut-down level is 10 °C (18 °F).
Delay at shut-down signal	Is the time for which the signal must exist before the compressor is shut down. If it is required to program this setting to another value, consult your supplier.
Minimum stop time	Once the compressor has automatically stopped, it will remain stopped for the minimum stop time, whatever happens with the net air pressure. Consult your supplier if a setting lower than 20 seconds is required.
Unloading/ Loading pressure	The regulator does not accept illogical settings, e.g. if the unloading pressure is programmed at 7.0 bar(e) (101 psi(g)), the maximum limit for the loading pressure changes to 6.9 bar(e) (100 psi(g)). The recommended minimum pressure difference between loading and unloading is 0.6 bar (9 psi(g)).

4 Installation

4.1 Dimension drawings

The dimension drawing can be found in the technical documentation, supplied with the unit.

Dimension drawing	Model
9828 5102 38-01	QGD 40, QGD 50, QGD 60 without integrated dryer, metric units
9828 5102 38-02	QGD 40, QGD 50, QGD 60 without integrated dryer, imperial units
9828 5102 39-01	QGD 40, QGD 50, QGD 60 with integrated dryer, metric units
9828 5102 39-02	QGD 40, QGD 50, QGD 60 with integrated dryer, imperial units

Text on drawings	Translation or Explanation
Cooling air outlet of compressor	Cooling air outlet of compressor and motor
Air inlet of compressor	Cooling air inlet of compressor and motor
Compressed air outlet	Compressed air outlet connection
Electrical cable passage	Electrical cable passage
Cooling air outlet of cubicle	Cubicle cooling air outlet
Doors fully open	Dimensions with doors fully open
Cooling air inlet of dryer	Dryer cooling air inlet
Cooling air outlet of dryer	Dryer cooling air outlet
Centre of gravity	Centre of gravity
Approx. mass	Approximate mass of the machine
Manual drain of after cooler	Manual drain, aftercooler
Automatic drain of after cooler	Connection of the automatic drain of the aftercooler
Manual drain of dryer	Manual drain of the dryer
Automatic drain of dryer	Connection of the automatic drain of the dryer
Mounting holes of compressor	Mounting holes to fixate the compressor

4.2 Installation proposal

Safety

	The operator must apply all relevant safety precautions, including those mentioned in this book.
---	--

Outdoor/altitude operation



The compressor is not designed for outdoor installation. The compressors can be sold with option rain protection. With this option, this compressor can be installed outside under a shelter, in frost free conditions. If frost might occur, the appropriate measures must be taken to avoid damage to the machine and its ancillary equipment. Consult your supplier.

Moving/lifting



The compressor can be moved by a lift truck using the slots in the frame. Take care not to damage the bodywork during lifting or transport. Make sure that the forks protrude from the other side of the frame. The compressor can also be lifted after inserting beams in the slots. Make sure that the beams cannot slide and that they protrude from the frame equally. The chains must be held parallel to the bodywork by chain spreaders in order not to damage the compressor. The lifting equipment must be placed in such a way that the compressor is lifted perpendicularly. Lift gently and avoid twisting.

Compressor room example

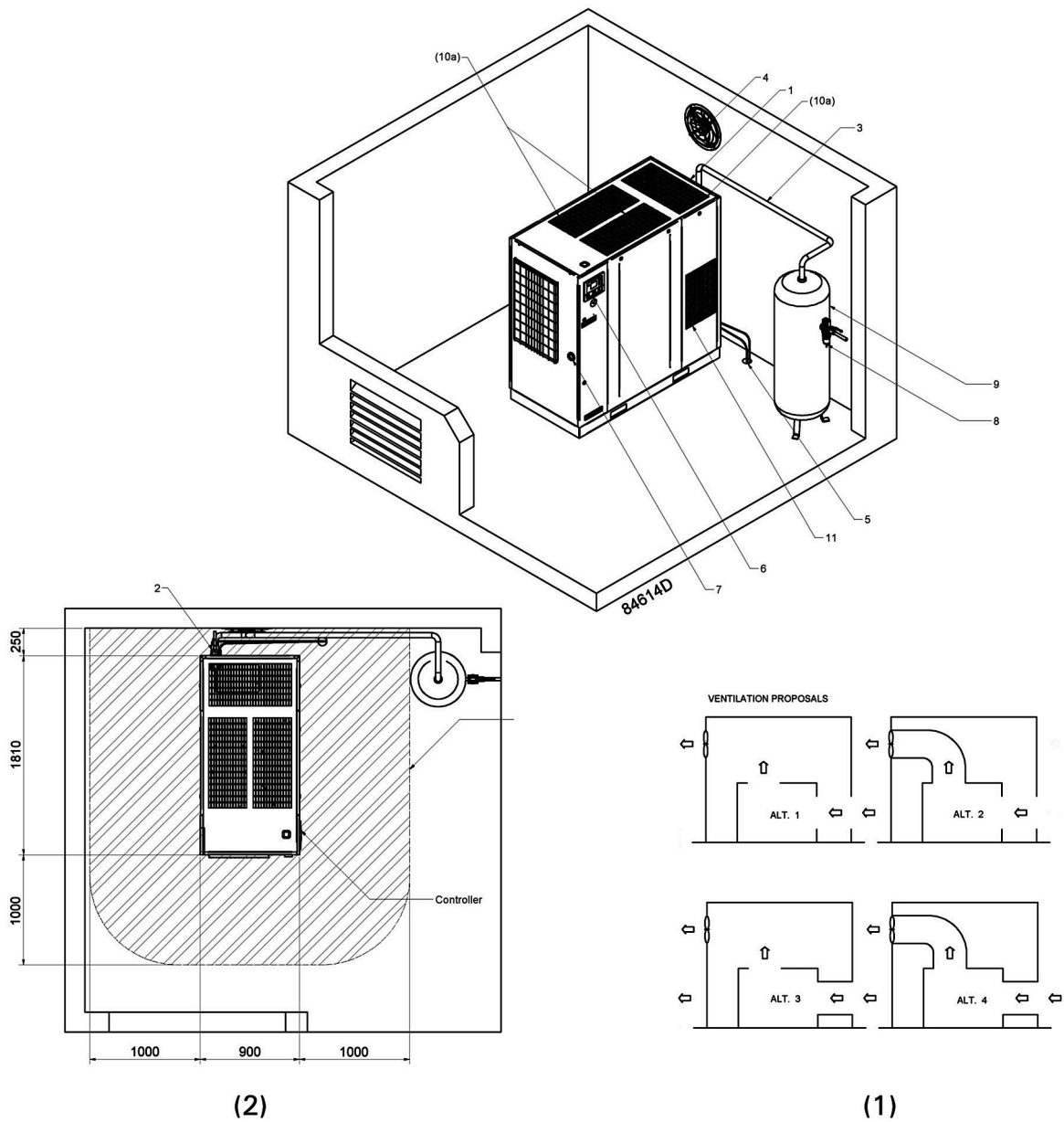

Text on drawing

Reference	Designation
(1)	Ventilation proposals
(2)	Minimum free area to be reserved for the compressor installation

	All piping to be connected stress-free to the compressor.
--	---

Installation guidelines

1. Install the compressor unit on a solid, level floor suitable for taking its weight.

2. Position of the compressed air outlet valve.
3. The pressure drop over the air delivery pipe can be calculated from:

$$\Delta p = (L \times 450 \times Q_c^{1.85}) / (d^5 \times P), \text{ with}$$

- Δp = pressure drop in bar (recommended maximum: 0.1 bar (1.5 psi))
- L = length of the pipe in m
- Q_c = Free air delivery of the compressor in l/s
- d = inner diameter of the pipe in mm
- P = absolute pressure at the compressor outlet in bar(a)

It is recommended that the connection of the compressor air outlet pipe is made on top of the main air net pipe in order to minimise carry-over of possible condensate residue.

4. Ventilation: the inlet grids and ventilation fan should be installed in such a way that any re-circulation of cooling air is avoided.

The maximum air velocity through the grids is 5 m/s (16.5 ft/s).

The maximum air temperature at the compressor intake is 46 °C (115 °F), the minimum air temperature is 0 °C (32 °F).

The required ventilation capacity to limit the compressor room temperature can be calculated as follows:

$$Q_v = 1.06 N / \Delta T \text{ for versions without dryer}$$

$$Q_v = (1.06 N + 1.3) / \Delta T \text{ for versions with dryer}$$

- Q_v = Required ventilation capacity in m³/s
 - N = Shaft input of compressor in kW
 - ΔT = Temperature increase in the compressor room in °C
5. The drain pipes to the drain collector must not dip into the water of the drain collector. Any flow back must be avoided. Oil/water separators to separate the major part of the oil from the condensate to ensure that the condensate meets the requirements of the environmental codes are available.
 6. Control module with monitoring panel.
 7. Position of the main cable entry. Power supply cable to be sized and installed by a qualified electrician.



To preserve the protection degree of the electric cubicle and to protect its components from dust from the environment, it is mandatory to use a proper cable gland when connecting the supply cable to the compressor.

8. Provision for inlet and outlet of the energy recovery system (system is optional).
9. The air receiver (optional) should be installed in a frost-free room on a solid, level floor for normal air consumption, the volume of the air net (receiver and piping) can be calculated as follows:

$$V = (0.25 \times Q_c \times P_1 \times T_o) / (f_{max} \times \Delta P \times T_1)$$

- V = Volume of the air net in l.
- Q_c = Free air delivery of the compressor in l/s
- P_1 = Compressor air inlet pressure in bar absolute
- f_{max} = Cycle frequency = 1 cycle/30s
- ΔP = P unload - P load in bar
- T_1 = Compressor air inlet temperature in K

- To= Air receiver temperature K
- To prevent feedback of exhaust air to the cooling inlet, sufficient space should be foreseen above the unit to evacuate the exhaust air.

4.3 Electrical connections

Important remark



To preserve the protection degree of the electric cubicle and to protect its components from dust from the environment, it is mandatory to use a proper cable gland when connecting the supply cable to the compressor.

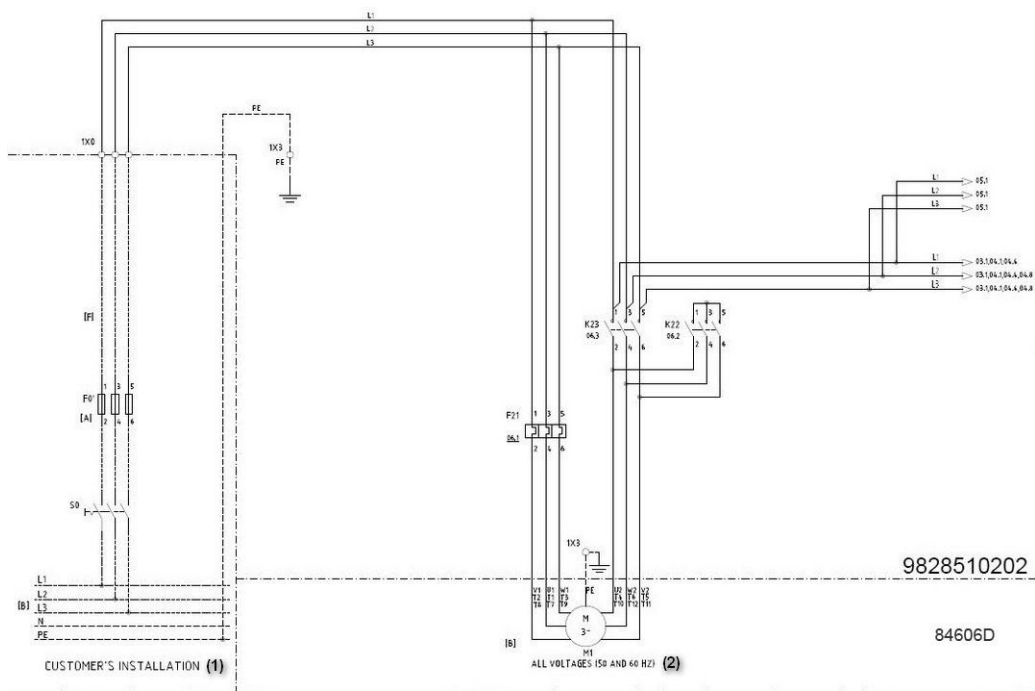

Electrical connections

Reference	Designation
(1)	Customer's installation
(2)	All voltages (50 and 60 Hz)

Instructions

1. Provide an isolating switch.
2. Check that the motor cables and wires inside the electric cabinet are clamped tight to their terminals.
3. Check the fuses and the setting of the overload relay. See section [Electrical cable size](#).
4. Connect earth conductor bolt (PE).
5. Connect the power supply cables to their terminals L1, L2, L3.

Compressor status indication

- Manual load/unload or automatic operation (K07)
- Warning condition (K08)
- Shut-down condition (K05)

Stop the compressor and switch off the voltage before connecting external equipment. Consult your supplier.

Compressor control mode

The following control modes can be selected:

- **Local control:** The compressor will react to commands entered by means of the buttons on the control panel. Compressor start/stop commands via Clock function are active, if programmed.
- **Remote control:** The compressor will react to commands from external switches. Emergency stop remains active. Compressor start/stop commands via Clock function are still possible.

Options:

- Remote starting and stopping (switch S1')
- Remote loading/unloading (switch S4')
- Remote pressure sensing (switch S' combined with pressure switch S4')

	<p>Have the modifications checked by your supplier. Stop the compressor and switch off the voltage before connecting external equipment. Only potential-free contacts are allowed.</p>
--	--



- **LAN control:** The compressor is controlled via a local network. Consult your supplier.







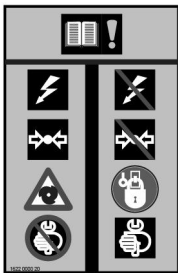
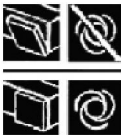

See service diagram 9828 5102 02 to locate the connectors.

4.4 Pictographs

Description

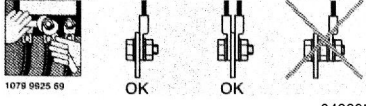
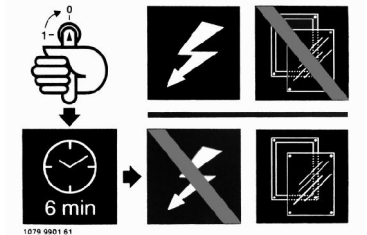
Pictographs

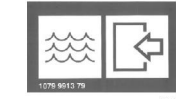
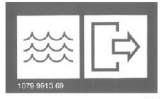
1	 84224D	2	 84231D
3	 84230D	4	 84234D



5	 <p>84221D</p>	6	 <p>1079 9901 18</p> <p>84219D</p>																														
7	 <p>84226D</p>	8	 <p>84228D</p>																														
9	 <p>1079 9904 29</p> <p>84227D</p>	10	<table border="1" data-bbox="986 683 1353 810"> <thead> <tr> <th>mm</th> <th>M2,5</th> <th>M3</th> <th>M3,5</th> <th>M4</th> <th>M5</th> <th>M6</th> <th>M8</th> <th>M10</th> <th>M12</th> </tr> </thead> <tbody> <tr> <td></td> <td>-</td> <td>1.2</td> <td>1.2</td> <td>1.2</td> <td>2.7</td> <td>7</td> <td>12</td> <td>20</td> <td>30</td> </tr> <tr> <td></td> <td>0.5</td> <td>0.5</td> <td>0.8</td> <td>1.2</td> <td>-</td> <td>3</td> <td>6</td> <td>10</td> <td>15.5</td> </tr> </tbody> </table>  <p>1079 9925 69</p> <p>OK OK</p> <p>84229D</p>	mm	M2,5	M3	M3,5	M4	M5	M6	M8	M10	M12		-	1.2	1.2	1.2	2.7	7	12	20	30		0.5	0.5	0.8	1.2	-	3	6	10	15.5
mm	M2,5	M3	M3,5	M4	M5	M6	M8	M10	M12																								
	-	1.2	1.2	1.2	2.7	7	12	20	30																								
	0.5	0.5	0.8	1.2	-	3	6	10	15.5																								
11	 <p>1079 9901 61</p> <p>84225D</p>	12	 <p>1079 9912 29</p> <p>84232D</p>																														
13	 <p>1079 9913 79</p> <p>84222D</p>	14	 <p>1079 9913 69</p> <p>84223D</p>																														
15	 <p>84145D</p>																																

Reference	Designation
1	Warning: Always read the manual, switch off the voltage, depressurise compressor and lock out/ tag out before repairing.
2	Keep the doors closed during operation
3	Switch off the voltage before removing protecting cover inside electric cubicle
4	Warning, voltage
5	Automatic condensate drain
6	Stop the compressor before cleaning the coolers
7	Lightly oil the gasket of the oil filter, screw it on and tighten by hand (approx. half a turn)

Reference	Designation
8	Before connecting the compressor electrically, consult the Instruction book for the motor rotation direction
9	Compressor remains pressurized for 180 seconds after switching off the voltage
10	Torques for steel (Fe) or brass (CuZn) bolts
11	Switch off the voltage and wait at least 6 minutes before removing the screen
12	Oil outlet
13	Cooling water inlet
14	Cooling water outlet
15	Automatic Restart After Voltage Failure (ARAVF)

5 Operating instructions

5.1 Initial start-up

	<p>The operator must apply all applicable Safety precautions.</p>
	<p>For the location of the air outlet valve and the drain connections, see sections Introduction and Condensate system.</p>

Preparations

1. Consult the sections [Electrical cable size](#), [Installation proposal](#) and [Dimension drawings](#).
2. **The following transport fixtures, painted red, must be removed:**
 - Bolt and bushes or support under the motor (1)
 - Bolts and bushes under the gear casing (2)
 - Bolts or bolts and bushes under the oil separator vessel (3)

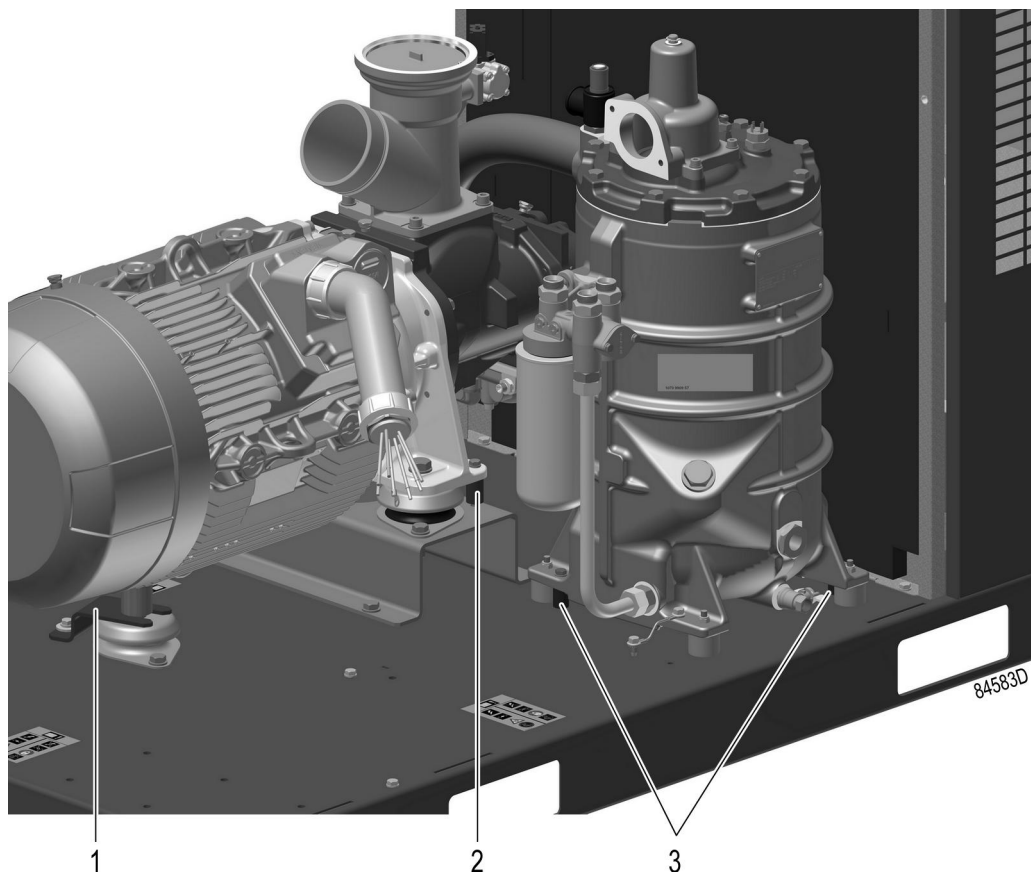

3. Check that the electrical connections correspond to the applicable codes and that all wires are clamped tight to their terminals.
The installation must be earthed and protected against short circuits by fuses of the inert type in all phases. An isolating switch must be installed near the compressor.
4. Check transformer (T1) for correct connection.
Check the settings of drive motor overload relay (F21).
Check that the motor overload relay is set for manual resetting.

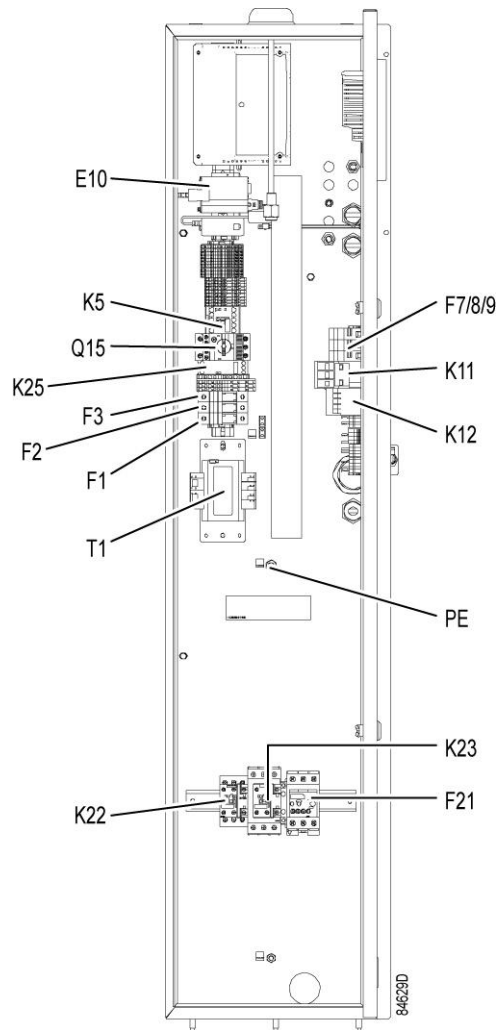

Electric cubicle (typical)

5. Check the setting of circuit breaker (Q15). Also check that the switch on the circuit breaker is in position I.
6. Fit air outlet valve (AV). See section [Introduction](#) for the location of the valve.
Close the valve.
Connect the air net to the valve.
On compressors equipped with a dryer bypass, fit the air outlet valve to the dryer bypass pipe.
7. Connect the condensate drain outlet(s) to a drain collector.
See section [Condensate system](#).
The drain pipes to the drain collector must not dip into the water. If there is a risk for freezing, the pipes must be insulated.
For draining of pure condensate water, install an oil/water separator which is available from Atlas Copco as an option.
8. **Provide labels, warning the operator that:**
 - The compressor may automatically restart after voltage failure (if activated, consult your supplier).
 - The compressor is automatically controlled and may be restarted automatically .

Initial start procedure

If the compressor has not run for the past 6 months, it is strongly recommended to improve the lubrication of the compressor element before starting.

To do so:

1. Disconnect the inlet hose.
2. Remove the unloader (UA).
3. Pour approximately 0.75 l (0.20 US gal, 0.17 Imp gal) of compressor oil into the compressor element inlet. For oil specifications, see section [Oil specifications](#).
4. Reinstall the unloader and reconnect the inlet hose.

Make sure that all connections are tight.

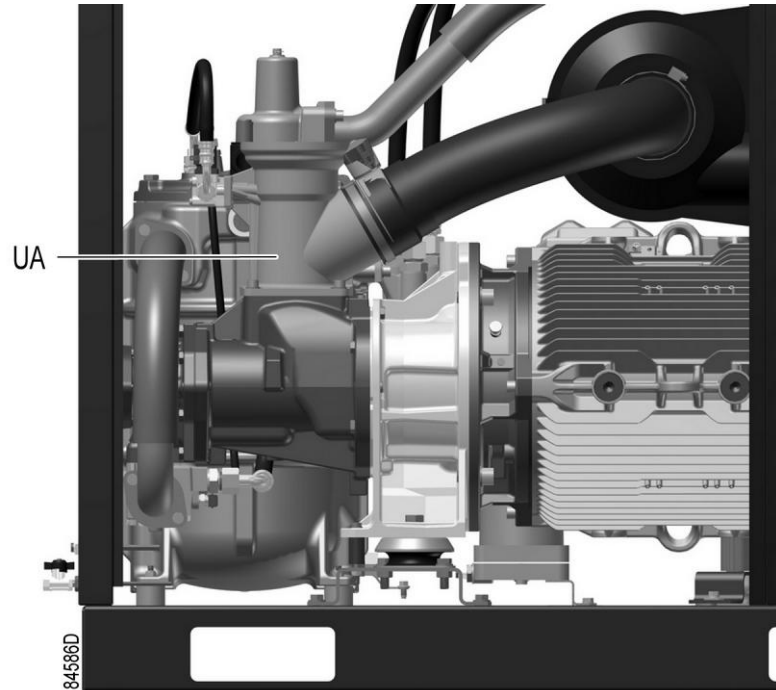

1. Check the oil level before starting.
The oil level should be between the oil filler neck (FC) and the bottom of the sight glass (GI).

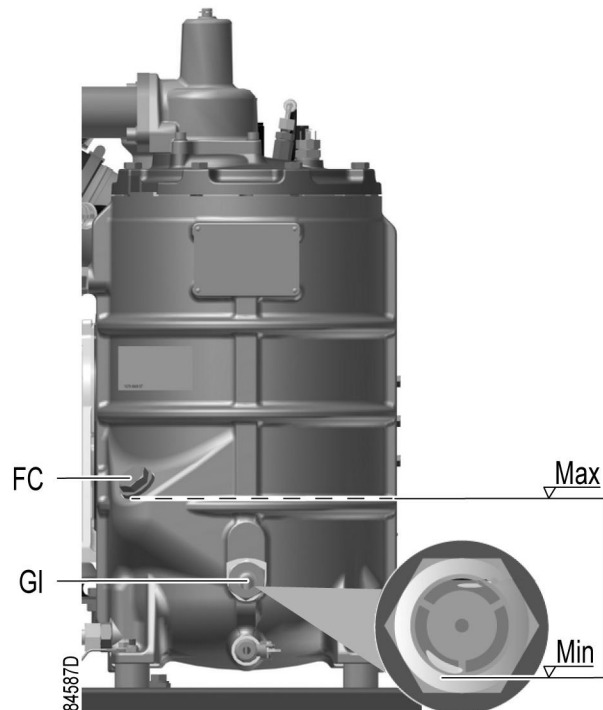

2. Switch on the voltage. Start the compressor and stop it immediately. Check the rotation direction of drive motor (M1) while the motor is coasting to a stop. The correct rotation direction of the drive motor is indicated by an arrow shown on the motor fan cowl. If the rotation direction of the drive motor is incorrect, open the isolating switch and reverse two incoming electric lines.
Incorrect rotation direction of the drive motor may cause damage to the compressor.
3. Check also the rotation direction of the fan motor. Rotation arrows, visible through the grating in the roof, are provided on the plate below the fan to indicate the correct rotation direction of the fan motor.
If the rotation direction of the fan motor is incorrect, open the isolating switch and reverse two incoming electric connections at the terminals of circuit breaker (Q15).
4. Start and run the compressor for a few minutes. Check that the compressor operates normally.
5. Check that the outlet temperature doesn't rise too much after start-up. The unit will shutdown when the outlet temperature is 65°C (149°F) above the inlet temperature.

5.2 Before starting

Procedure

1. If the compressor has not run for the past 6 months, it is strongly recommended to improve the lubrication of the compressor element before starting. See section [Initial start](#).
2. Check oil level. Top up if necessary.

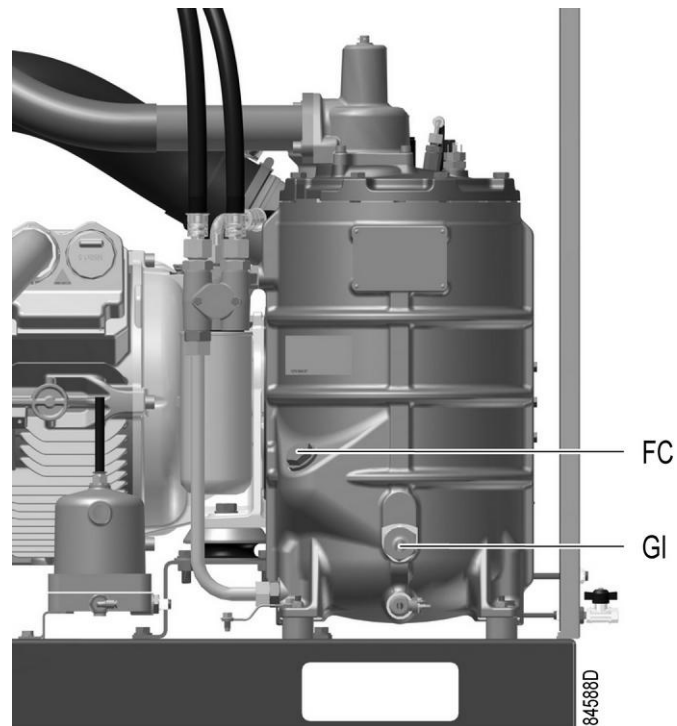

Position of oil level sight glass

3. If necessary, empty the dust trap of the filter, see section [Air filter](#).
If the red part of the air filter service indicator shows full out, replace the air filter element.
Reset the service indicator (VI) by pushing the knob in the extremity of the indicator.

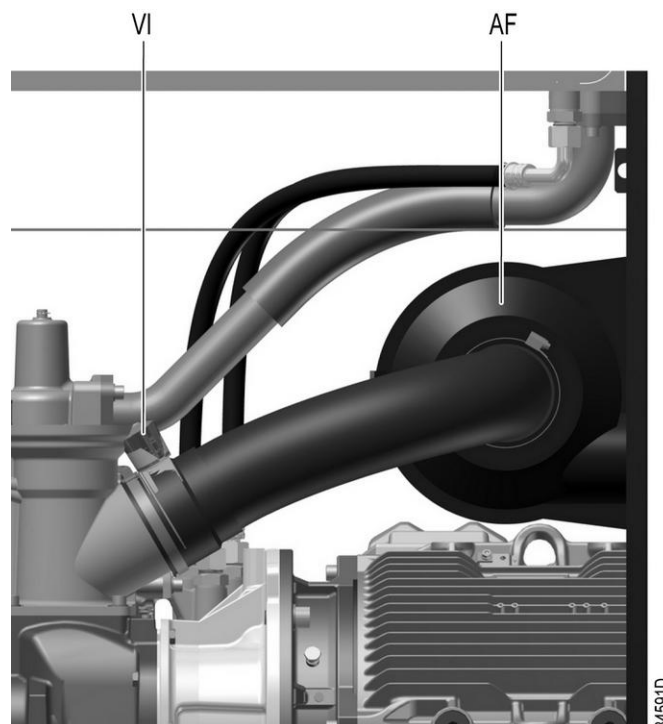

Position of air filter and service indicator

5.3 Starting

	For the position of the air outlet valve and the drain connections, see sections Introduction and Condensate system .
---	---

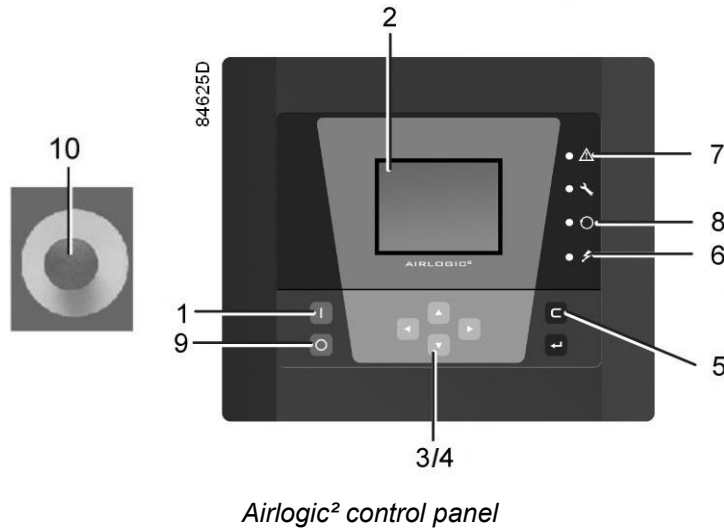



Procedure

1. Open the air outlet valve.
2. Switch on the voltage. Check that voltage on LED (6) lights up.
3. Press start button (1) on the control panel. The compressor starts running and the automatic operation LED (8) lights up. Ten seconds after starting, the drive motor switches over from star to delta and the compressor starts running loaded.

5.4 During operation

Warnings

	The operator must apply all relevant Safety precautions . Also consult section Problem solving .
	Keep the doors closed during operation. They may be opened for short periods only to carry out checks.
	When the motors are stopped and LED (8) (automatic operation) is alight, the motors may start automatically.

Checking the oil level

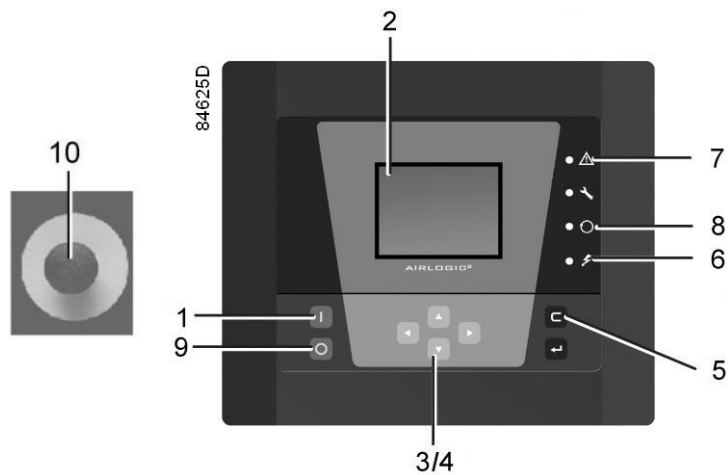

Airlogic² control panel

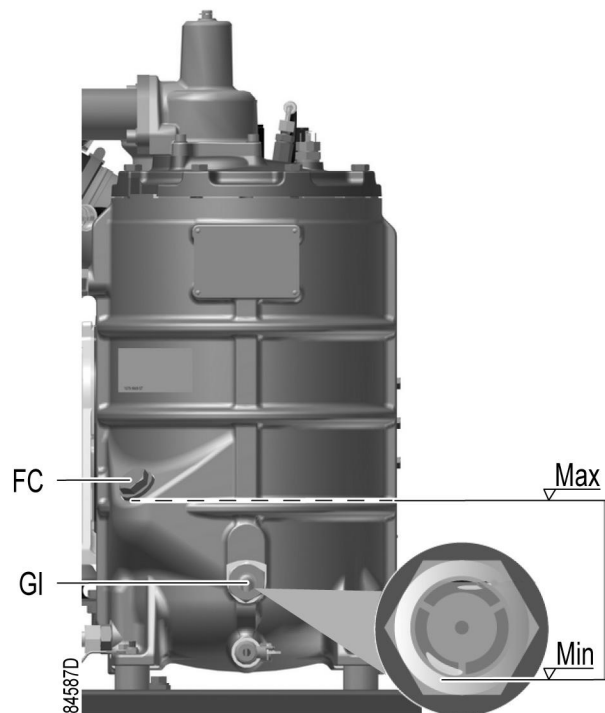

Regularly check the oil level. To do so:

1. Press stop button (9).
2. A few minutes after stopping, the oil level should be between the oil filler neck (FC) and the bottom of the sight glass (GI).
3. If the oil level is too low, push the emergency stop button (10) to avoid the compressor to start unexpectedly.
4. Next, close the air outlet valve and open the manual drain valve (Dm) until the air system between oil separator/air receiver vessel and outlet valve is fully depressurized. See section [Condensate system](#) for location of the outlet valve and water drain.
5. Unscrew oil filler plug (FC) one turn to permit any pressure left in the system to escape. Wait a few minutes.
6. Remove the plug and add oil until the level reaches the filler opening.

7. Fit and tighten the plug (FC).

Air filter

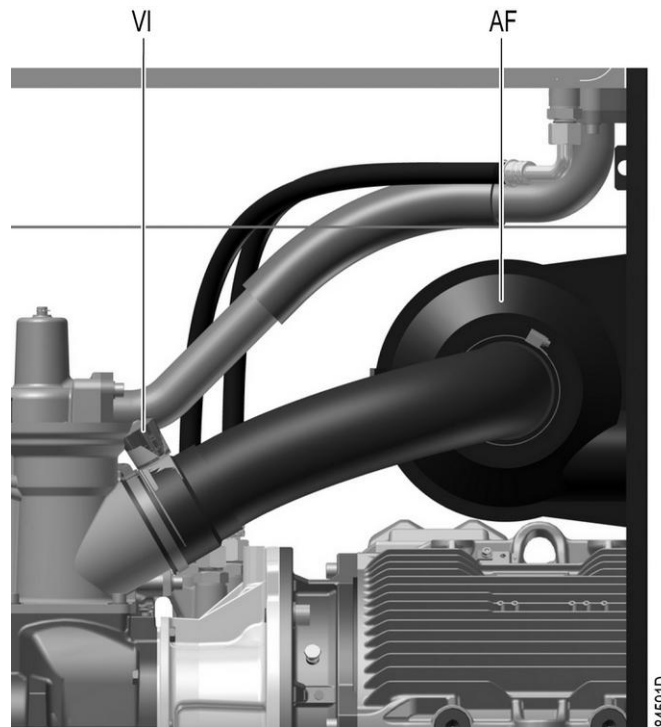

Position of the service indicator

Regularly check the service indicator. If the colored part of service indicator (VI) shows full out, replace the air filter element. Reset the service indicator by pushing the knob in the extremity of the indicator body.

Drains

Regularly check that condensate is discharged during operation. See section [Condensate system](#). The amount of condensate depends on environmental and working conditions.

5.5 Checking the display

5.6 Stopping

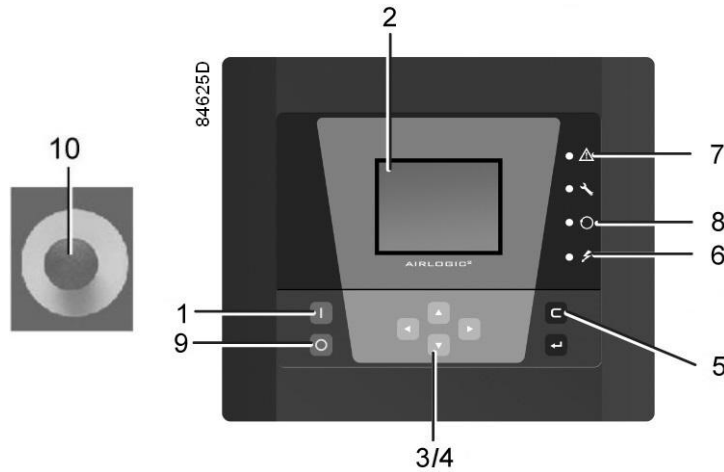

Airlogic² control panel

Procedure

Step	Action
1	Press stop button (9). Automatic operation LED (8) goes out and the compressor stops after 30 seconds of unloaded operation.
2	To stop the compressor in the event of an emergency, press emergency stop button (10). Alarm LED flashes (7). Do not use emergency stop button for normal stopping!
3	Close the air outlet valve.
4	Press the test button on top of the electronic water drain(s) (if supplied) to the depressurize the piping between air receiver and outlet valve, next open the manual drain valve (Dm). See section Condensate system . Switch off the voltage.

5.7 Taking out of operation

Warning



The operator must apply all relevant [Safety precautions](#).



Procedure

Step	Action
-	Stop the compressor and close the air outlet valve.
-	Press the test button on top of the electronic water drain(s) until the air system between air receiver and outlet valve is fully depressurized. Consult section Condensate system to locate the drain valve.
-	Switch off the voltage and disconnect the compressor from the mains.
-	Open the condensate drain valve(s) (Dm).
-	Unscrew the oil filler plug only one turn to permit any pressure in the system to escape. Consult section Oil and oil filter change to locate the filler plug.
-	Shut off and depressurise the part of the air net which is connected to the outlet valve. Disconnect the compressor air outlet pipe from the air net.
-	Drain the oil.
-	Drain the condensate circuit and disconnect the condensate piping from the condensate net.

6 Maintenance

6.1 Preventive maintenance schedule

Warning

	<p>Always apply all relevant Safety precautions. Before carrying out any maintenance, repair work or adjustments, proceed as follows:</p> <ul style="list-style-type: none"> • Stop the compressor. • Close the air outlet valve and open the manual drain valve until the air system between air receiver and outlet valve is fully depressurized. • Press the emergency stop button. • Switch off the voltage. Open and lock the isolating switch. • Depressurize the compressor by opening the oil filler plug one turn.
	<p>Only pressing the emergency stop button is not sufficient to make the compressor voltage free. If the machine is equipped with an automatic restart after voltage failure function and if this function is active, be aware that the machine will restart automatically when the power is restored if it was running when the power was interrupted.</p>

Warranty - Product Liability

Use only authorized parts. Any damage or malfunction caused by the use of unauthorized parts is not covered by Warranty or Product Liability.

Service kits

For overhauling or carrying out preventive maintenance, service kits are available. Consult the Spare Parts list for part numbers.

Service contracts

Your supplier offers several types of service contracts, relieving you of all preventive maintenance work. Consult your customer center.

General

When servicing, replace all removed O-rings and washers.

Intervals

The local customer centre may overrule the maintenance schedule, especially the service intervals, depending on the environmental and working conditions of the compressor.

The longer interval checks must also include the shorter interval checks.

Regular maintenance

Following actions have to be done on a regular basis:

Maintenance checklist

Period	Operation
Daily	Check oil level. Check readings on the controller display. Check the air filter service indicator. Check that condensate is discharged during operation of the compressor. Drain condensate. Check the pressure dew point temperature (on compressors with integrated dryer).
3-monthly (1)	Check coolers. Clean if necessary. Check cooling fins of electric motor(s). Clean if necessary. Remove the air filter element and inspect. If necessary, clean using an air jet. Replace damaged or heavily contaminated elements. Check the filter element of the electric cabinet. Replace if necessary. On compressors with integrated dryer: <ul style="list-style-type: none"> • Stop the compressor, close the air outlet valve and switch off the voltage. • Remove any dirt from the condenser inlet with a vacuum cleaner. • Next, clean with an air jet in the reverse direction of the normal flow. Use low pressure air. Keep the compressed air nozzle more than 30 cm away from the condenser to avoid damaging the condenser fins. • Remove dust from inside the dryer, e.g. with a vacuum cleaner. Do not use water or solvents to clean the condenser.
Yearly	Check the condition of all hoses. Replace if necessary.

(1): More frequently when operating in a dusty atmosphere

Programmed service interventions

Apart from the above mentioned actions, a number of service interventions (see the table below) are programmed in the controller. Each plan has a programmed time interval at which all service actions belonging to that plan are to be carried out. When reaching the interval, a message will appear on the screen indicating which service plans are to be carried out.

See section [Service menu](#) for compressors with an Airlogic² controller.

After servicing, the intervals must be reset.

See section [Service menu](#) for compressors with an Airlogic² controller.

Preventive Maintenance schedule programmed in the controller

	A-service Every 4000 running hours (1)	B-service Every 8000 running hours (2)	D-Service Every 24000 running hours
Change the air filter	x	x	x
Change the electric cabinet filter mats	x	x	x
Change the oil		x (3)	x
Change the oil filter	x	x	x
Re-grease the drive motor bearings	x	x	x
Change the air inlet filter mat(s)		x	x
Change the oil separator element		x	x
Overhaul non return valve of the scavenge line		x	x

Overhaul the unloader		x	x
Overhaul the minimum pressure valve		x	x
Change the thermostatic valve		x	x
Overhaul the condensate drain(s)		x	x
Overhaul the main drive motor			x
Overhaul the compressor element			x (4)

(1): Or yearly (indicated by real time counter), whichever comes first.

(2): Or every 2 years (indicated by real time counter), whichever comes first.

(3): Or as indicated by oil analysis.

(4): For compressor elements used on operating pressures below or equal to 10 bar (145 psi), the overhaul can be postponed to 32000 running hours.

	<ul style="list-style-type: none"> • Consult your supplier before modifying a timer setting. • For the change interval of oil and oil filter in extreme conditions consult your customer centre. • Any leakage should be attended to immediately. Damaged hoses or flexible joints must be replaced.
--	---

6.2 Oil specifications

It is strongly recommended to use genuine lubricants from your manufacturer. They are the result of years of field experience and research. See section Preventive maintenance schedule for the advised replacement intervals and consult the Spare Parts list for part number information.

	<p>Avoid mixing lubricants of different brands or types as they may not be compatible and the oil mix may have inferior properties. A label, indicating the type of oil filled ex factory, is stuck on the canopy.</p>
--	--

6.3 Drive motor

General

Keep the outside of the electric motor clean for efficient cooling. If necessary, remove dust with a brush and/or compressed air jet.

6.4 Air filter

Location of air filter

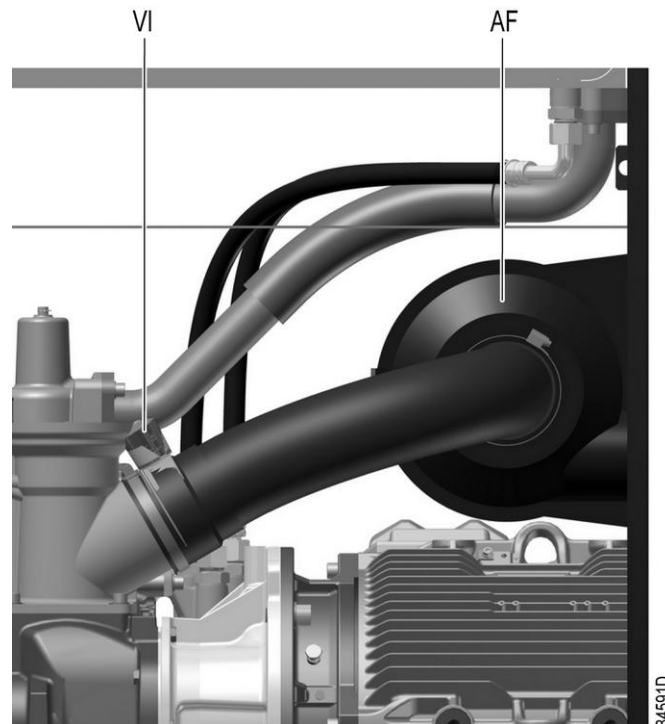

Recommendations

1. Never remove the element while the compressor is running.
2. For minimum downtime, replace the dirty element by a new one.
3. Discard the element when damaged.

Procedure

1. Stop the compressor. Switch off the voltage.
2. Release the snap clips of air filter (AF) and remove the cover and the air filter element. Discard the filter element.
3. Fit the new element and the cover.
4. Reset service indicator (VI) by pushing the knob in the extremity of the body.
5. Reset the air filter service warning.
For compressors equipped with a graphic controller, see section [Service menu](#).

6.5 Oil and oil filter change

Warning



The operator must apply all relevant [Safety precautions](#). Always drain the compressor oil at all drain points. Used oil left in the compressor can contaminate the oil system and can shorten the lifetime of the new oil. Never mix lubricants of different brands or types as they may not be compatible and the oil mix will have inferior properties. A label, indicating the type of oil filled ex-factory, is stuck on the air receiver/oil tank.

Procedure

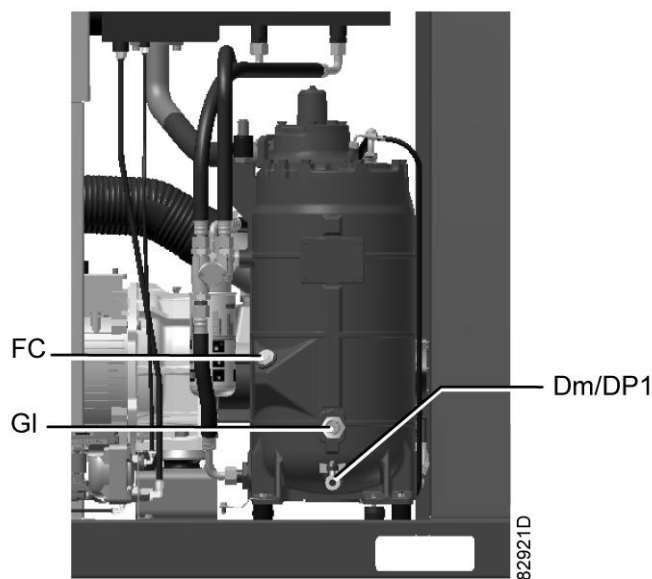

Oil drain and filler plug on the oil separator vessel

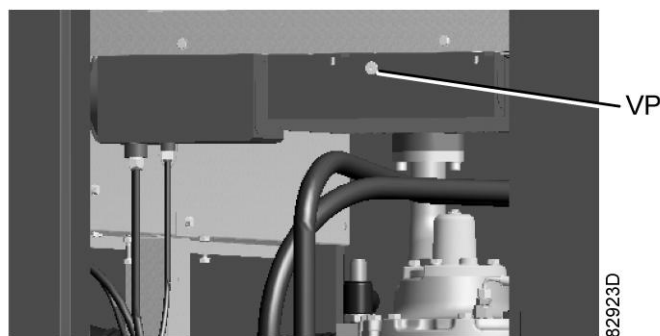

Vent plug, oil cooler

Step	Description
1	Run the compressor until warm. Stop the compressor after 3 minutes of unloaded operation. Close the air outlet valve and switch off the voltage. Wait a few minutes and depressurise by unscrewing oil filler plug (FC) just one turn to permit any pressure in the system to escape.
2	Air cooled units: loosen the vent plug (VP) of the oil cooler and wait for 5 minutes.
3	Remove drain plug (DP1) and open drain valve (Dm).
4	Collect the oil in a collector and deliver it to the local collection service. Refit and tighten the drain and vent plugs after draining. Close the drain valve (Dm).
5	Remove the oil filter (OF). Be aware that this filter has a left thread connection. Clean the seat on the manifold. Oil the gasket of the new filter and screw it into place. Tighten firmly by hand.
6	Remove filler plug (FC). Fill the air receiver (AR) with oil until the level reaches the filler neck. Take care that no dirt drops into the system. Refit and tighten filler plug (FC).
7	Run the compressor loaded for a few minutes. Stop the compressor and wait a few minutes to allow the oil to settle.
8	Depressurise the system by unscrewing filler plug (FC) just one turn to permit any pressure in the system to escape. Remove the plug. Fill the air receiver with oil until the level reaches the filler neck. Tighten the filler plug.
9	Reset the service warning after carrying out all service actions in the relevant Service Plan: For compressors with a graphic controller, see section Service menu .

6.6 Coolers

General

Keep the coolers clean to maintain their efficiency.

Instructions for air-cooled compressors

- Stop the compressor, close the air outlet valve and switch off the voltage.
- Cover all parts under the coolers.
- Remove the service plates. (1)

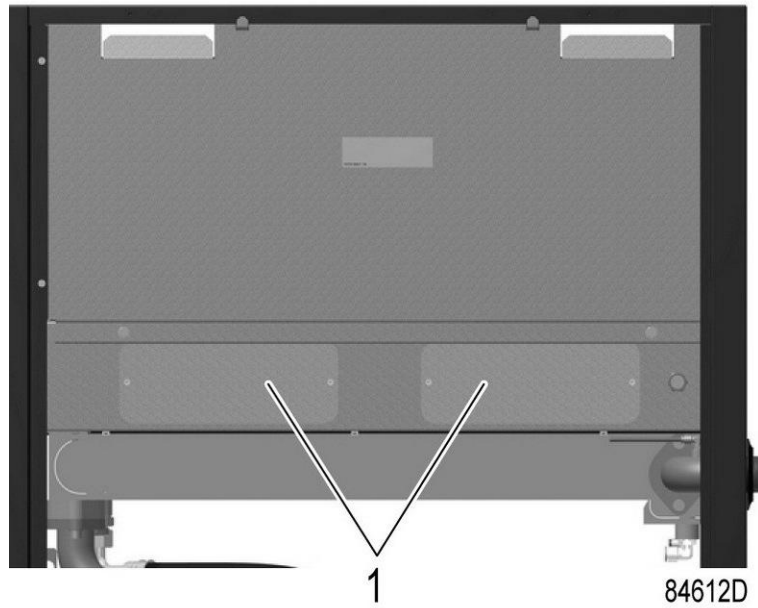

- Remove any dirt from the coolers with a fibre brush. Brush in the direction of the cooling fins. Also remove any dirt from the fan with a fibre brush.
- Next, clean with an air jet in the reverse direction to normal flow. Use low pressure air. If necessary, the pressure may be increased up to 6 bar(e) (87 psig).
- If it is necessary to wash the coolers with a cleaning agent, consult your supplier.
- Remove the cover used during cleaning.
- Mount the service plates. (1)

6.7 Safety valves

Location of safety valve

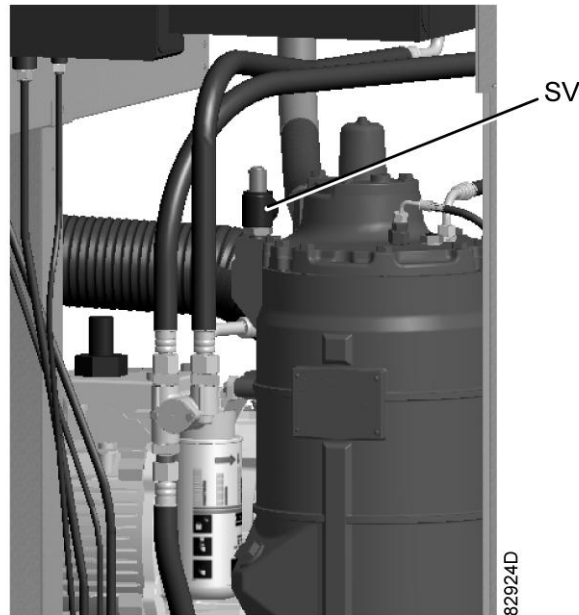

Position of safety valve

Operating

Operate the safety valve from time to time by unscrewing the cap one or two turns. Retighten it afterwards.

Testing

Before removing the valve, depressurize the compressor. See also section Problem solving.

The safety valve (SV) can be tested on a separate air line. If the valve does not open at the set pressure stamped on the valve, it needs to be replaced.

Warning

No adjustments are allowed. Never run the compressor without safety valve.

6.8 Dryer maintenance instructions

Safety precautions

Refrigeration dryers of ID type contain refrigerant HFC.

When handling refrigerant, all applicable [safety precautions](#) must be observed. Please be specifically aware of the following points:

- Contact of refrigerant with the skin will cause freezing. Special gloves must be worn. If contacted with the skin, the skin should be rinsed with water. On no account may clothing be removed.
- Fluid refrigerant will also cause freezing of the eyes; always wear safety glasses.
- Refrigerant is harmful. Do not inhale refrigerant vapours. Check that the working area is adequately ventilated.

Be aware that certain components such as the refrigerant compressor and the discharge pipe can become quite hot (up to 110 °C - 230 °F). Therefore, wait until the dryer has cooled down before removing the panels.

Before starting any maintenance or repair work, switch off the voltage and close the air inlet and outlet valves.

Local legislation

Local legislation may stipulate that:

- Work on the refrigerant circuit of the cooling dryer or on any equipment which influences its function must be undertaken by an authorised control body.
- The installation should be checked once a year by an authorised control body.

General

For all references see section Introduction.

The following remarks should be kept in mind:

- Keep the dryer clean.
- Brush or blow off the finned surface of condenser monthly.
- Stop the compressor, close the air outlet valve and switch off the voltage.
- Remove any dirt on the condenser inlet with a vacuum cleaner.
- Next, clean with an air jet in the reverse direction to normal flow. Use low pressure air. If necessary, the pressure may be increased up to 6 bar(e) (87 psig).
- Clean the condenser area with a vacuum cleaner.
- Inspect and clean the electronic condensate drain monthly.

6.9 Service kits

Service kits

For overhauling and for preventive maintenance, a wide range of service kits is available. Service kits comprise all parts required for servicing the component and offer the benefits of genuine parts while keeping the maintenance budget low.

Also a full range of extensively tested lubricants, suitable for your specific needs is available to keep the compressor in excellent condition.

Consult the Spare Parts List for part numbers.

6.10 Storage after installation

Procedure

Run the compressor regularly, e.g. twice a week, until warm. Load and unload the compressor a few times.



If the compressor is going to be stored without running from time to time, protective measures must be taken. Consult your supplier.

7 Problem solving

Warning

	Always apply all relevant Safety precautions .
	<p>Before carrying out any maintenance, repair work or adjustment, press the stop button, wait until the compressor has stopped and close the air outlet valve. Open the manual drain valve(s). Press the emergency stop button and switch off the voltage. Open and lock the isolating switch. Depressurise the oil separator vessel by opening the oil filler plug one turn. For location of components: see sections Introduction, Condensate system and Initial start.</p>
	<p>The air outlet valve can be locked during maintenance or repair as follows:</p> <ul style="list-style-type: none"> • Close the valve. • Remove the screw fixing the handle with the wrench delivered with the compressor. • Lift the handle and turn it until the slot of the handle fits over the blocking edge on the valve body. • Fit the screw.
	<ul style="list-style-type: none"> • Always switch off the voltage. Only pressing the emergency stop button is not sufficient to make the compressor voltage free. • If the machine is equipped with an automatic restart after voltage failure function and if this function is active, be aware that the machine will restart automatically when the power is restored if it was running when the power was interrupted.

Faults and remedies, compressor

On compressors equipped with a graphic controller, if the alarm LED is lit or flashes, consult sections [Event history menu](#) or [Service menu](#).

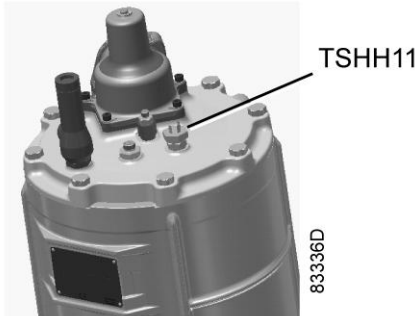
Condition	Fault	Remedy
Compressor does not start or stops during operation.	Motor overload relay (F21) open	Find cause and remedy. Replace if necessary.
	Circuit breaker (Q15) or fan motor overload (F15) open	Find cause and remedy. Replace if necessary.
	<p>Too high temperature in oil separator vessel or temperature switch (TSHH1) defective</p> 	Find cause and remedy. Replace if necessary.

Condition	Fault	Remedy	
	Phase sequence relay (K25) open	Find cause and remedy. Replace if necessary.	
	Wiring interrupted	Find cause and remedy. Replace if necessary.	
Compressor starts running, but does not load after a delay time	Solenoid valve out of order	Replace valve	
	Inlet valve stuck in closed position	Have valve checked	
	Leak in control air tubes	Replace leaking tubes	
	Minimum pressure valve leaking (when air net is depressurised)	Have valve checked	
Compressor does not unload, safety valve blows	Solenoid valve out of order	Replace valve	
	Inlet valve does not close	Have valve checked	
Condensate is not discharged from condensate separator during loading	Discharge tube clogged	Check and correct as necessary	
Compressor air output or pressure below normal	Air consumption exceeds air delivery of compressor	Check the connected equipment.	
	Choked air filter element	Replace filter element	
	Solenoid valve malfunctioning	Replace valve	
	Leak in control air tubes	Replace leaking tubes	
	Oil separator element clogged	Have element replaced	
	Air leakage	Have leaks repaired.	
	Safety valve leaking	Replace valve	
	Inlet valve does not fully open	Have valve checked	
	Compressor element out of order	Consult your supplier	
	Excessive oil consumption; oil carry-over through discharge line	Incorrect oil causing foam	Change to correct oil
		Oil level too high	Check for overfilling. Release pressure and drain oil to correct level.
		Oil separator defective	Replace oil separator element
	Safety valve blows after loading	Inlet valve malfunctioning	Have valve checked
Minimum pressure valve malfunctioning		Have valve checked	
Safety valve out of order		Have valve replaced	
Oil separator element clogged		Have oil separator element replaced	
Compressor element out of order		Consult your supplier	
Compressor element outlet temperature or delivery air temperature above normal	Oil level too low	Check and correct	

Condition	Fault	Remedy
	Insufficient cooling air or cooling air temperature too high	Check for cooling air restriction or improve ventilation of the compressor room. Avoid recirculation of cooling air. If installed, check capacity of compressor room fan
	Oil cooler clogged	Clean cooler
	Bypass valve malfunctioning	Have valve tested
	Air cooler clogged	Clean cooler
	Compressor element out of order	Consult your supplier
Cooling air fan does not deliver enough air.	Unit shuts down due to overtemperature, fan overload, too high oil consumption or less FAD.	Fan rotates in the wrong direction due to wrong electrical connection.

Faults and remedies, dryer

For all references hereafter, consult section [Air dryer](#).

Condition	Fault	Remedy
Pressure dew point too high	Air inlet temperature too high	Check and correct; if necessary, clean the aftercooler of the compressor
	Ambient temperature too high	Check and correct; if necessary, draw cooling air via a duct from a cooler place or relocate the compressor
	Shortage of refrigerant	Have circuit checked for leaks and recharged
	Refrigerant compressor does not run	See below
	Evaporator pressure too high	See below
	Condenser pressure too high	See below
Condenser pressure too high or too low	Fan control switch out of order	Replace
	Fan blades or fan motor out of order	Have checked fan/fan motor, if necessary replace.
	Ambient temperature too high	Check and correct; if necessary, draw cooling air via a duct from a cooler place or relocate the compressor
	Condenser externally clogged	Clean condenser
Compressor stops or does not start	Electric power supply to compressor is interrupted	Check and correct as necessary
	Thermal protection of refrigerant compressor motor has tripped	Motor will restart when motor windings have cooled down

Condition	Fault	Remedy
Condensate drain remains inoperative	Drain system clogged	Have system inspected Clean the filter of the drain by opening the manual drain valve. On units with an electronic drain, check functioning of the drain by pushing the test button.
Condensate trap continuously discharges air and water	Drain out of order	Have system checked. If necessary, replace the drain.
Evaporator pressure is too high or too low at unload	Hot gas bypass valve incorrectly set or out of order	Have hot gas bypass valve adjusted
	Condenser pressure too high or too low	See above
	Shortage of refrigerant	Have circuit checked for leaks and recharged if necessary

8 Technical data

8.1 Readings on display



Airlogic² Controller

Important



The readings mentioned below are valid under the reference conditions (see section [Reference conditions and limitations](#)).

Reference	Reading
Air outlet pressure	Modulates between programmed unloading and loading pressures.
Compressor element outlet temperature	Approx. 60 °C (108 °F) above cooling air inlet temperature.
Dewpoint temperature	See section Compressor data .

8.2 Electric cable size and fuses

Important



- The voltage on the compressor terminals must not deviate more than 10% of the nominal voltage.
It is however highly recommended to keep the voltage drop over the supply cables at nominal current below 5% of the nominal voltage (IEC 60204-1).
 - If cables are grouped together with other power cables, it may be necessary to use cables of a larger size than those calculated for the standard operating conditions.
 - Use the original cable entry. See section [Dimension drawings](#).
- To preserve the protection degree of the electric cubicle and to protect its components from dust from the environment, it is mandatory to use a fitting cable gland when connecting the supply cable to the compressor.**
- Use single core cables in conduit if two multicore cables do not fit in the supply cable entrance.
- Local regulations remain applicable if they are stricter than the values proposed below.
 - Currents are calculated with the full service factor but we suggest to add 10% due to over- and under-voltage.
Fuses are maximum allowed values calculated for full service factor and 10% over- and under-voltage.
 - **Caution:**
 - Always double-check the fuse size versus the calculated cable size. If required, reduce fuse size or enlarge cable size.
 - Cable length should not exceed the maximum length according to IEC 60204 table 10.

Currents and fuses

UL/cUL approval

Compressor type			I (1)	Max. fuse (1)	I (2)	Max. fuse (2)
				K5/ HRC form II		K5/ HRC form II
	V	Hz	A	A	A	A
QGD 40	230	60	298.2	350	306.2	350
QGD 40	380	50	176.8	200	180.9	200
QGD 40	380	60	179.4	200	184.2	200
QGD 40	460	60	149.4	175	153.5	175
QGD 40	575	60	120.4	150	124.0	150

UL/cUL approval

Compressor type			I (1)	Max. fuse (1)	I (2)	Max. fuse (2)
				K5/ HRC form II		K5/ HRC form II
	V	Hz	A	A	A	A
QGD 50	230	60	352.2	400	362.6	400
QGD 50	380	50	218.8	250	222.9	250
QGD 50	380	60	221.4	250	226.2	250
QGD 50	460	60	182.4	200	188.8	225
QGD 50	575	60	145.9	160	151.6	175

UL/cUL approval

Compressor type			I (1)	Max. fuse (1)	I (2)	Max. fuse (2)
				K5/ HRC form II		K5/ HRC form II
	V	Hz	A	A	A	A
QGD 60	230	60	440.8	500	451.2	500
QGD 60	380	50	260.8	300	264.9	300
QGD 60	380	60	267.5	300	272.3	300
QGD 60	460	60	222.2	250	228.6	250
QGD 60	575	60	176.6	200	182.3	200

I: current in the supply lines at maximum load and nominal voltage

(1): compressors without integrated dryer

(2): compressors with integrated dryer

Fuse calculations for cUL and UL: The indicated fuse size is the maximum fuse size in order to protect the motor against short circuit. For cUL fuse HRC form II, for UL fuse class RK5.

Possible configurations

There are 3 possible cabling layouts:

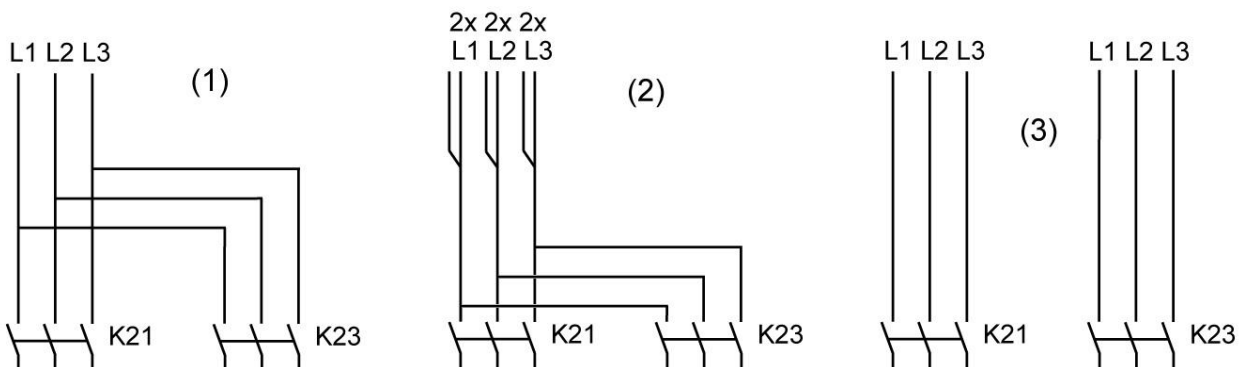

- (1): Single supply cables.
- (2): Parallel supply cables

- (3) is only valid for Y-D versions

Cable sizing according to UL/cUL

Calculation method according to UL 508A, table 28.1 column 5: allowable ampacities of insulated copper conductors (75 °C (167 °F)).

Maximum allowed current in function of the wire size

AWG or kcmil	Maximum current
10	< 30 A
8	< 50 A
6	< 65 A
4	< 85 A
3	< 100 A
2	< 115 A
1	< 130 A
1/0	< 150 A
2/0	< 175 A
3/0	< 200 A

Calculation method for UL:

- Single supply cables (3 phases + 1 PE - configuration (1)):
 - Add 25 % to the total current from the tables (see UL 508A 28.3.2: "Ampacity shall have 125 % of the full load current")
 - Install the prescribed maximum fuse on each cable
- Parallel supply cable (2 x 3 phases + 2 PE - configuration (2)):
 - Add 25 % to the total current from the tables and divide by 2
 - Multiply the ampacity of the cables with 0.8 (see UL 508A table 28.1 continued)
 - Install fuses of half the size of the recommended maximum fuse size on each cable.
- When using 2 x 3 phase + 2 PE as in (3):
 - Add 25 % to the total current from the tables and divide by $\sqrt{3}$
 - Multiply the ampacity of the cables with 0.8 (see UL 508A table 28.1 continued)
 - Fuse size: the recommended maximum fuse size divided by $\sqrt{3}$ on each cable.
- Size PE cable:
 - For supply cables up to AWG8: same size as the supply cables
 - For supply cables larger than AWG8: use maximum allowed ampacity of the selected supply cables and compare with value in table below (see CEC Part 1 table 17)

< 100 A: use AWG8
< 200 A: use AWG6
< 300 A: use AWG4

Always check the voltage drop over the cable (less than 5 % of the nominal voltage is recommended).

Example of supply cable calculation: $I_{tot} = 128$ A, maximum ambient temperature is 45 °C, recommended fuse = 150 A

- Single supply cables (3 phases + 1 PE - configuration (1)):

- $I = 128 \text{ A} + 25 \% = 128 \times 1.25 = 160 \text{ A}$
- For AWG2/0, the maximum current is 175 A, which is sufficient => use AWG2/0
- Install the prescribed maximum fuse (150 A) on each cable
- Parallel supply cable (2 x 3 phases + 2 PE - configuration (2)):
 - $I = (128 \text{ A} + 25\%)/2 = (128 \times 1.25)/2 = 80 \text{ A}$
 - For a AWG4, the maximum current is $85 \text{ A} \times 0.8 = 68 \text{ A}$, which is insufficient. For an AWG3, the maximum current is $100 \times 0.8 = 80 \text{ A}$. So 2 parallel cables of 3 x AWG3 + 2 x AWG8 are sufficient.
 - Install 80 A fuses on each cable.

8.3 Protection settings

Setting motor overload relay (F21)

Frequency (Hz)	Voltage (V)	40HP F21 (A)	50HP F21 (A)	60HP F21 (A)
UL/cUL				
60	230	67.9	77.0	96.3
50	380	40.2	47.8	57.1
60	380	40.9	48.5	58.4
60	460	33.9	39.8	48.5
60	575	27.4	31.9	38.5

Settings for fan motor overload protection (Q15)

Frequency (Hz)	Voltage (V)	40HP Q15 (A)	50HP Q15 (A)	60HP Q15 (A)
UL/cUL				
60	230	4.2	4.2	5.8
50	380	2.8	2.8	2.8
60	380	2.4	2.4	3.5
60	460	2.4	2.4	3.2
60	575	1.9	1.9	2.6

8.4 Dryer switches

General

The regulating and safety devices are factory-adjusted to give optimum performance of the dryer. Do not alter the setting of any of the devices.

8.5 Reference conditions and limitations

Reference conditions

Air inlet pressure (absolute)	bar	1
Air inlet pressure (absolute)	psi	14.5
Air inlet temperature	°C	20
Air inlet temperature	°F	68
Relative humidity	%	0
Working pressure		See section Compressor data.

Limits

Maximum working pressure		See section Compressor data.
Minimum working pressure	bar(e)	4
Minimum working pressure	psig	58
Maximum air inlet temperature	°C	46
Maximum air inlet temperature	°F	115
Minimum ambient temperature	°C	0
Minimum ambient temperature	°F	32

8.6 Compressor data

Reference conditions

	All data specified below apply under reference conditions, see section Reference conditions and limitations .
---	---

QGD 40

		7.5 bar	8.5 bar	10 bar	100 psi	125 psi	150 psi
Frequency	Hz	50	50	50	60	60	60
Maximum (unloading) pressure	bar(e)	7.5	8.5	10	7.4	9.1	10.8
Maximum (unloading) pressure	psig	109	123	145	107	132	157
Maximum (unloading) pressure, units with integrated dryer	bar(e)	7.3	8.3	9.8	7.2	8.9	10.6
Maximum (unloading) pressure, units with integrated dryer	psig	106	120	142	104	129	154
Reference working pressure	bar(e)	7	8	9.5	6.9	8.6	10.3
Reference working pressure	psig	102	116	138	100	125	150
Pressure drop over dryer, units with integrated dryer	bar(e)	0.25	0.25	0.25	0.25	0.25	0.25

		7.5 bar	8.5 bar	10 bar	100 psi	125 psi	150 psi
Pressure drop over dryer, units with integrated dryer	psig	3.6	3.6	3.6	3.6	3.6	3.6
Set point of thermostatic valve	°C	40	40	40	40	40	40
Set point of thermostatic valve	°F	104	104	104	104	104	104
Motor shaft speed	r/min	2956	2956	2956	3565	3565	3565
Nominal motor power	kW	30	30	30	30	30	30
Nominal motor power	hp	40.2	40.2	40.2	40.2	40.2	40.2
Temperature of air leaving outlet valve	°C	27	27	27	27	27	27
Temperature of air leaving outlet valve	°F	81	81	81	81	81	81
Pressure dew point, units with integrated dryer	°C	3	3	3	3	3	3
Pressure dew point, units with integrated dryer	°F	37.4	37.4	37.4	37.4	37.4	37.4
Temperature of air leaving outlet valve, units with integrated dryer	°C	23	23	23	23	23	23
Temperature of air leaving outlet valve, units with integrated dryer	°F	73	73	73	73	73	73
Dryer power at full load, units with integrated dryer	kW	1.4	1.4	1.4	1.6	1.6	1.6
Dryer power at full load, units with integrated dryer	hp	1.9	1.9	1.9	2.1	2.1	2.1
Dryer power at no load, units with integrated dryer	kW	1.2	1.2	1.2	1.4	1.4	1.4
Dryer power at no load, units with integrated dryer	hp	1.6	1.6	1.6	1.9	1.9	1.9
Refrigerant type, units with integrated dryer		R410A	R410A	R410A	R410A	R410A	R410A
Refrigerant quantity, units with integrated dryer	kg	0.8	0.8	0.8	0.9	0.9	0.9
Refrigerant quantity, units with integrated dryer	lb	1.8	1.8	1.8	1.9	1.9	1.9
Oil capacity	l	16.4	16.4	16.4	16.4	16.4	16.4
Oil capacity	US gal	4.12	4.12	4.12	4.12	4.12	4.12
Sound pressure level (according to ISO 2151:2004)	dB(A)	66	66	66	66	66	66

QGD 50

		7.5 bar	8.5 bar	10 bar	100 psi	125 psi	150 psi
Frequency	Hz	50	50	50	60	60	60
Maximum (unloading) pressure	bar(e)	7.5	8.5	10	7.4	9.1	10.8
Maximum (unloading) pressure	psig	109	123	145	107	132	157
Maximum (unloading) pressure, units with integrated dryer	bar(e)	7.3	8.3	9.8	7.2	8.9	10.6
Maximum (unloading) pressure, units with integrated dryer	psig	106	120	142	104	129	154
Reference working pressure	bar(e)	7	8	9.5	6.9	8.6	10.3

		7.5 bar	8.5 bar	10 bar	100 psi	125 psi	150 psi
Reference working pressure	psig	102	116	138	100	125	150
Pressure drop over dryer, units with integrated dryer	bar(e)	0.25	0.25	0.25	0.25	0.25	0.25
Pressure drop over dryer, units with integrated dryer	psig	3.6	3.6	3.6	3.6	3.6	3.6
Set point of thermostatic valve	°C	40	40	40	40	40	40
Set point of thermostatic valve	°F	104	104	104	104	104	104
Motor shaft speed	r/min	2956	2956	2956	3565	3565	3565
Nominal motor power	kW	37	37	37	37	37	37
Nominal motor power	hp	49.6	49.6	49.6	49.6	49.6	49.6
Temperature of air leaving outlet valve	°C	27	27	27	27	27	27
Temperature of air leaving outlet valve	°F	81	81	81	81	81	81
Pressure dew point, units with integrated dryer	°C	3	3	3	3	3	3
Pressure dew point, units with integrated dryer	°F	37.4	37.4	37.4	37.4	37.4	37.4
Temperature of air leaving outlet valve, units with integrated dryer	°C	23	23	23	23	23	23
Temperature of air leaving outlet valve, units with integrated dryer	°F	73	73	73	73	73	73
Dryer power at full load, units with integrated dryer	kW	1.34	1.4	1.4	1.6	1.6	1.6
Dryer power at full load, units with integrated dryer	hp	1.8	1.9	1.9	2.2	2.1	2.1
Dryer power at no load, units with integrated dryer	kW	1.2	1.2	1.2	1.4	1.4	1.4
Dryer power at no load, units with integrated dryer	hp	1.6	1.6	1.6	1.9	1.9	1.9
Refrigerant type, units with integrated dryer		R410A	R410A	R410A	R410A	R410A	R410A
Refrigerant quantity, units with integrated dryer	kg	1	0.8	0.8	1	0.9	0.9
Refrigerant quantity, units with integrated dryer	lb	2.1	1.8	1.8	2.2	1.9	1.9
Oil capacity	l	17.7	17.7	17.7	17.7	17.7	17.7
Oil capacity	US gal	4.12	4.12	4.12	4.12	4.12	4.12
Sound pressure level (according to ISO 2151:2004)	dB(A)	67	67	67	67	67	67

QGD 60

		7.5 bar	8.5 bar	10 bar	100 psi	125 psi	150 psi
Frequency	Hz	50	50	50	60	60	60
Maximum (unloading) pressure	bar(e)	7.5	8.5	10	7.4	9.1	10.8
Maximum (unloading) pressure	psig	109	123	145	107	132	157
Maximum (unloading) pressure, units with integrated dryer	bar(e)	7.3	8.3	9.8	7.2	8.9	10.6

		7.5 bar	8.5 bar	10 bar	100 psi	125 psi	150 psi
Maximum (unloading) pressure, units with integrated dryer	psig	106	120	142	104	129	154
Reference working pressure	bar(e)	7	8	9.5	6.9	8.6	10.3
Reference working pressure	psig	102	116	138	100	125	150
Pressure drop over dryer, units with integrated dryer	bar(e)	0.25	0.25	0.25	0.25	0.25	0.25
Pressure drop over dryer, units with integrated dryer	psig	3.6	3.6	3.6	3.6	3.6	3.6
Set point of thermostatic valve	°C	40	40	40	40	40	40
Set point of thermostatic valve	°F	104	104	104	104	104	104
Motor shaft speed	r/min	2956	2956	2956	3565	3565	3565
Nominal motor power	kW	45	45	45	45	45	45
Nominal motor power	hp	60.4	60.4	60.4	60.4	60.4	60.4
Temperature of air leaving outlet valve	°C	27	27	27	27	27	27
Temperature of air leaving outlet valve	°F	81	81	81	81	81	81
Pressure dew point, units with integrated dryer	°C	3	3	3	3	3	3
Pressure dew point, units with integrated dryer	°F	37.4	37.4	37.4	37.4	37.4	37.4
Temperature of air leaving outlet valve, units with integrated dryer	°C	23	23	23	23	23	23
Temperature of air leaving outlet valve, units with integrated dryer	°F	73	73	73	73	73	73
Dryer power at full load, units with integrated dryer	kW	1.34	1.34	1.4	1.6	1.6	1.6
Dryer power at full load, units with integrated dryer	hp	1.8	1.8	1.9	2.2	2.1	2.1
Dryer power at no load, units with integrated dryer	kW	1.2	1.2	1.2	1.4	1.4	1.4
Dryer power at no load, units with integrated dryer	hp	1.6	1.6	1.6	1.9	1.9	1.9
Refrigerant type, units with integrated dryer		R410A	R410A	R410A	R410A	R410A	R410A
Refrigerant quantity, units with integrated dryer	kg	1	1	0.8	1	0.9	0.9
Refrigerant quantity, units with integrated dryer	lb	2.1	2.1	1.8	2.2	1.9	1.9
Oil capacity	l	19	19	19	19	19	19
Oil capacity	US gal	4.39	4.39	4.39	4.39	4.39	4.39
Sound pressure level (according to ISO 2151:2004)	dB(A)	70	70	70	70	70	70

9 Instructions for use

Oil separator vessel

This vessel can contain pressurized air. This can be potentially dangerous if the equipment is misused.
This vessel must only be used as a compressed air/oil separator tank and must be operated within the limits specified on the data plate.
No alterations must be made to this vessel by welding, drilling or other mechanical methods without the written permission of the manufacturer.
The pressure and temperature of this vessel must be clearly indicated.
The safety valve must correspond with pressure surges of 1.1 times the maximum allowable operating pressure. It should guarantee that the pressure will not permanently exceed the maximum allowable operating pressure of the vessel.
Use only oil as specified by the manufacturer.

10 Guidelines for inspection

Guidelines

On the Declaration of Conformity / Declaration by the Manufacturer, the harmonised and/or other standards that have been used for the design are shown and/or referred to.

The Declaration of Conformity / Declaration by the Manufacturer is part of the documentation that is supplied with this compressor.

Local legal requirements and/or use outside the limits and/or conditions as specified by the manufacturer may require other inspection periods as mentioned below.

11 Pressure equipment directives

Components subject to 2014/68/EU Pressure Equipment Directive

The following table contains the necessary information for the inspection of all pressure equipment of category II and higher according to the Pressure Equipment Directive 2014/68/EU and all pressure equipment according to the Simple Pressure Vessel Directive 2014/29/EU.

Compressor type	Component	Description	Volume	Design pressure	Minimum and maximum design temperature	PED Class
30-45 kW	1625 430224	Vessel	30 l	15 bar(e)	-10 °C/ 120 °C	II
	0830 101068	Safety valve	-	-	-	IV
	0830 101069	Safety valve	-	-	-	IV

Compressor type	Component	Description	Number of cycles (1)	Minimum wall thickness	Inspection frequency (2)
30-45 kW	1625 5641 99	Vessel	2 x 10 ⁶	8 mm	10 years
	0830 1010 68	Safety valve	-	-	-
	0830 1010 69	Safety valve	-	-	-

The compressors conform to PED smaller than category II.

(1) The number of cycles refers to the number of cycles from 0 bar(e) to maximum pressure.

(2) The minimum wall thickness must be respected at all times. Inspection techniques such as ultrasonic or X-ray are equivalent to hydrostatic testing for this equipment.

12 Declaration of conformity

Insert logo here

EU DECLARATION OF CONFORMITY

1
 2 We, (1) declare under our sole responsibility, that the product
 3 Machine name :
 4 Machine type :
 5 Serial number :
 6
 7 Which falls under the provisions of article 12.2 of the EC Directive 2006/42/EC on the approximation of the laws of the Member States relating to machinery, is in conformity with the relevant Essential Health and Safety Requirements of this directive.

The machinery complies also with the requirements of the following directives and their amendments as indicated.

	Directive on the approximation of laws of the Member States relating to	Harmonized and/or Technical Standards used	Att'mnt
a	(2)	(3)	
b			X
c			
d			X
e			
f			
g			X

8.a The harmonized and the technical standards used are identified in the attachments hereafter

8.b <1> is authorized to compile the technical file.

	Conformity of the specification to the directives	Conformity of the product to the specification and by implication to the directives
--	--	--

11 Issued by	Engineering	Manufacturing
--------------	-------------	---------------

13
 14 Name
 15 Signature
 16 Date
 17 Place

84950D

Typical example of a Declaration of Conformity document

(1): Contact address:

Quincy Compressor
 701 North Dobson Avenue
 Bay Minette, AL 36507
 United States

(2): Applicable directives

(3): Standards used

On the Declaration of Conformity / Declaration by the Manufacturer, the harmonized and/or other standards that have been used for the design are shown and/or referred to.

The Declaration of Conformity / Declaration by the Manufacturer is part of the documentation that is supplied with this device.

Performance You Demand. Reliability You Trust.



www.quincycompressor.com

No. 2920 7190 02 / 2021 - 08 - Printed in Belgium