

PSE

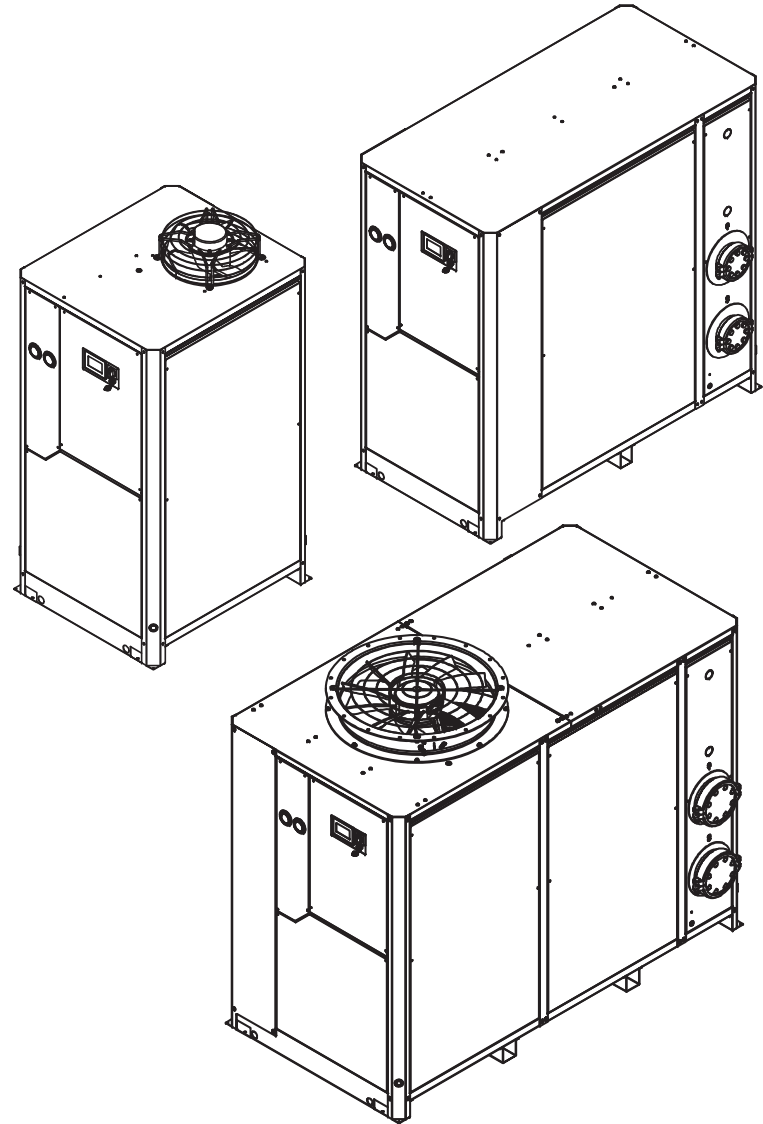

Refrigeration Dryer (60Hz)

PSE1400
PSE1600
PSE2000
PSE2400
PSE3000
PSE3800
PSE5000
PSE6000



EN User Manual
ES Manual de uso
FR Manuel d'utilisation

DATE: 14.02.2022 - Rev. 09
CODE: 398H271747



Index





1 Safety	1
1.1 Importance of the manual.....	1
1.2 Warning signals.....	1
1.3 Safety instructions	1
1.4 Residual risks.....	1
2 Introduction	2
2.1 Transportation	2
2.2 Handling.....	2
2.3 Inspection	2
2.4 Storage.....	2
3 Installation	2
3.1 Procedures.....	2
3.2 Operating space.....	2
3.3 Condenser Types	2
3.4 Installation Environment.....	2
3.5 Electrical connection.....	2
3.6 Condensate drain connection.....	2
4 Commissioning	2
4.1 Preliminary checks.....	2
4.2 Starting.....	2
4.3 Operation	3
4.4 Stop.....	3
5 Control	3
5.1 Home screen.....	3
5.2 Main menu	3
5.2.1 Machine status (I/O)	3
5.2.2 Pressure	4
5.2.3 Temperature	4
5.2.4 General.....	4
5.2.4.1 Language	5
5.2.4.2 Date/Time.....	5
5.2.4.3 Parameter.....	5
5.2.5 Serial number date.....	6
5.2.6 Download	6
5.3 Alarms/warnings	7
5.3.1 List of alarms/warnings	7
5.4 Rapid menu	8
6 Maintenance	9
6.1 General instructions	9
6.2 Refrigerant	9
6.3 Preventive Maintenance Programme.....	9
6.4 Dismantling	9
7 Troubleshooting	10
8 Appendix	

1 Safety

1.1 Importance of the manual

- Keep it for the entire life of the machine.
- Read it before any operation.
- Parker reserves the right to make changes to this user manual. Refer to the version that comes with the unit.

1.2 Warning signals



	Instruction for avoiding danger to persons
	Instruction for avoiding damage to the equipment.
	The presence of a skilled or authorized technician is required.
	There are symbols whose meaning is given in the para. 8.1

1.3 Safety instructions

 Every unit is equipped with an electric disconnecting switch for operating in safe conditions. Always use this device in order to eliminate risks during maintenance.

 This user manual is intended to aid both the end-user and service technician. Only a trained, qualified technician should remove panels to perform service.

 Do not exceed the design limits given on the data plate.

  It is the user's responsibility to avoid loads different from the internal static pressure. The unit must be appropriately protected whenever risks of seismic phenomena exist.

 Any safety devices for the compressed air circuit are to be provided by the user and must be selected according to the specification of the system and in accordance with local legislation.

Only use the unit for professional work and for its intended purpose.

The user is responsible for analyzing the application aspects for product installation, and following all the applicable industrial and safety standards and regulations contained in the product instruction manual or other documentation supplied with the unit.

Tampering or replacement of any parts by unauthorized personnel and/or improper machine use exonerate the manufacturer from all responsibility and invalidate the warranty.

The manufacturer declines present or future liability for damage to persons, things and the machine, due to negligence of the operators, non-compliance with all the instructions given in this manual, and non-application of current regulations regarding safety of the system.

The manufacturer declines any liability for damage due to alterations and/or changes to the packing.

It is the responsibility of the user to ensure that the specifications provided for the selection of the unit or components and/or options are fully comprehensive for the correct or foreseeable use of the machine itself

or its components.

 **IMPORTANT:** The manufacturer reserves the right to modify this manual at any time to provide the most comprehensive and updated information. The user is advised to consult the manual supplied with the unit.

1.4 Residual risks

The installation, start up, stopping and maintenance of the machine must be performed in accordance with the information and instructions given in the supplied technical documentation and always in such a way to avoid creating of a hazardous situation.

Some risks remain, that were unable to be eliminated during the design stage, which are listed below:

Part affected	Residual risk	Manner of exposure	Precautions
heat exchanger coil	small cuts	contact	avoid contact, wear protective gloves
fan grill and fan	lesions	insertion of pointed objects through the grill while the fan is in operation	do not poke objects of any type through the fan grill or place any objects on the grill
inside the unit: compressor and discharge pipe	burns	contact	avoid contact, wear protective gloves
inside the unit: metal parts and electrical wires	intoxication, electrical shock, serious burns	defects in the insulation of the power supply lines upstream of the electrical panel; live metal parts	adequate electrical protection of the power supply line; ensure metal parts are properly connected to earth
outside the unit: area surrounding the unit	intoxication, serious burns	fire due to short circuit or overheating of the supply line upstream of the unit's electrical panel	ensure conductor cross-sectional areas and the supply line protection system conform to applicable regulations

2 Introduction

This manual is in reference to Parker PSE1400-6000 refrigeration dryers designed to remove water vapor from compressed air.

2.1 Transportation

The packed unit must:

- remain upright;
- be protected against atmospheric agents;
- be protected against impacts.

2.2 Handling

Use a properly suited fork-lift truck for lifting. Avoid any type of impact when handling the dryer.

2.3 Inspection

- All the units are assembled, wired, charged with refrigerant and oil and tested under standard operating conditions in the factory;
- on receiving the machine check its condition: immediately notify the transport company in case of any damage;
- To avoid unnecessary handling of the dryer, unpackage the unit as close as possible to the place of installation.

2.4 Storage

If stacking is required, follow the instructions stated on the packaging. Keep the unit packaged in a clean, dry area that is protected from the elements, direct sunlight and/or other harsh conditions.

3 Installation

☞ Only competent personnel trained, qualified, and approved by Parker should perform installation, commissioning, service and repair procedures. Use caution when near the dryer and wear the proper protective equipment.

⚠ If installed in a place with fire hazard, provide a suitable fire-extinguishing system. The installed product must be protected against fire risk(Ref. EN378-3)

3.1 Procedures

Install indoors in a clean, dry area that is protected from the elements, direct sunlight and/or other harsh conditions.

☞ Comply with the instructions given in par. 8.2 and 8.3.

For reliable operation and warranty purposes, proper pre-filtration is recommended. Without a pre-filtration the dryer may see degradation in performance and/or permanent dryer failure. Warranty will be voided if the inlet air quality does not meet the required ISO8573-1 Class for particulate and total oil. Seller is excluded from any obligation of compensation or refund for and direct or indirect damage caused by its absence.

☞ Pre-filter element must be replaced at least once a year, or sooner as per manufacturer recommendations.

☞ Correctly connect the dryer to the compressed air inlet/outlet connections using pipe or hose that meets the temperature and pressure

requirements of the air compressor output. (see par.8.3 and 8.6).

3.2 Operating space

Leave a space of 5ft (1.5 m) around the unit.

Leave a space of 6,5ft (2 m) above dryer models with vertical condensation air expulsion.

3.3 Condenser Types

Air-cooled version (Ac)

Standard condenser type for all PSE models. Note: Do not duct away, create cooling air recirculation situations or obstruct the ventilation grills.

Water-cooled version (Wc)

Water-cooled version (Wc) - Note: It is recommended that a mesh filter be installed on the cooling water inlet (not included with PSE as standard).

☞  Inlet condensation water characteristics:

Temperature	≥50°F (10°C)	CL ⁻	<50 ppm
ΔT IN/OUT	41°-59°F (5-15°C)	CaCO ₃	70-150 ppm
Max % glycol	50	O ₂	<0.1 ppm
Pressure	43.5-145 PSig (3-10 barg)	Fe	<0.2 ppm
PH	7.5-9	NO ₃	<2 ppm
Electrical conductivity	10-500 μS/cm	HCO ₃ ⁻	70-300 ppm
Langelier saturation index	0-1	H ₂ S	<0.05 ppm
SO ₄ ²⁻	<50 ppm	CO ₂	<5 ppm
NH ₃	<1 ppm	Al	<0.2 ppm

Note: For special cooling water types, such as demineralized, deionized or distilled, it is necessary to contact the manufacturer to verify if the standard PSE condenser is suitable.

3.4 Installation Environment

PSE dryers are to be installed indoors only. To prevent damage to the internal parts of the dryer and air compressor, avoid installations where the surrounding air contains solid and/or gaseous pollutants (e.g. sulphur, ammonia, chlorine and installations in marine environments). The ducting of extracted air is not allowed for versions with axial fans.

3.5 Electrical connection

Use approved cable in that conforms with the local laws and regulations (for minimum cable section, see par. 8.3).

Install a differential thermal magnetic circuit breaker with contact opening distance 0.12in (3 mm) ahead of the system (RCCB - IDn = 0.3A) (see the relevant current local regulations).

The nominal current of the magnetic circuit breaker must be equal to the FLA with an interruption curve type D.

Select the power supply and insert a bridge as shown below:

S7-S6 for 400/3/50

S8-S6 for 460/3/60

Inside the electrical panel there is an instruction label.

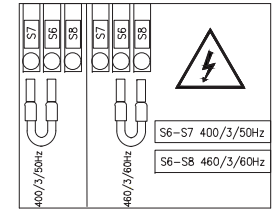

3.6 Condensate drain connection

☞ Make a connection to the draining system. Avoid connecting to a closed circuit shared by other pressurized discharge lines. Ensure proper condensate discharge. Dispose of all the condensate in conformity with current local environmental regulations.

4 Commissioning

4.1 Preliminary checks

Before commissioning the dryer, make sure:

- All information in section 3 was read, understood and carried out properly;
- the compressed air inlet and outlet isolation valves are closed and no air is flowing through the dryer;
- the power supply is correct;
- Note: If using a Wc version, open the cooling water circuit 5 minutes before starting the dryer.

4.2 Starting

- Switch the power on by turning the MAIN SWITCH “” to “I ON”:

⚠ **THE CRANKCASE HEATER MUST BE SWITCHED ON 12 HOURS BEFORE STARTING THE DRYER.**



EN - THE CRANKCASE HEATER MUST BE SWITCHED ON 12 HOURS BEFORE STARTING THE DRYER.



IT - LA RESISTENZA CARTER DEVE ESSERE INSERITA 12 ORE PRIMA DI AVVIARE L'ESSICCATORE.





FR - LA RESISTANCE CARTER DOIT ETRE BRANCHEE 12 HEURES AVANT LA MISE EN MARCHE DU SECHEUR.



DE - DIE VERSORGUNG DER KURBELWANNENHEIZUNG IST 12 STUNDEN VOR DER EINSCHALTUNG DES TROCKNERS FREIZUGEBEN.

touch to see home screen

- Touch  to start, the button changes the color from grey to

green, to signal that the dryer is now in operation .
Failure to comply with this rule may cause serious damage to the compressor.

c) Start the dryer without the air compressor load;

 Fans (Ac version): if connected with the wrong phase sequence they turn in the opposite direction, with the risk of being damaged (in this case the air exits the dryer cabinet from the condenser grilles instead from the fan grille - see par. 8.6 and 8.7 for correct air flow); immediately invert two phases.

- d) Wait 5 minutes, then slowly & partially open the inlet valve. Let the dryer reach line pressure before fully opening the inlet valve.
- e) Once the dryer is at line pressure and the inlet valve is completely open, slowly open the air outlet valve; the dryer is now drying.

Phases Monitor

If appears to display the alarm “phase monitor “, during the start up of the dryer, the user must verify the wiring of the input terminals of the disconnecting switch of the dryer.

4.3 Operation

- a) Always leave the dryer on when the compressor is on and working.
- b) The dryer operates automatically , therefore constant field adjustment to settings is not required. See section 5 for navigating controls.
- c) In the event of unforeseen excess air flows or spikes in moisture load, by-pass the dryer to avoid overloading it.
- d) Avoid inlet air temperature fluctuations.

4.4 Stop

- a) Stop the compressor or the air flow through the dryer and wait 2 minutes before shutting down the dryer;
Close the inlet air valve to ensure compressed air does not enter the dryer when disconnected or if an alarm occurs.
- b) Press  to switch off the dryer.

The button changes color from green to gray 





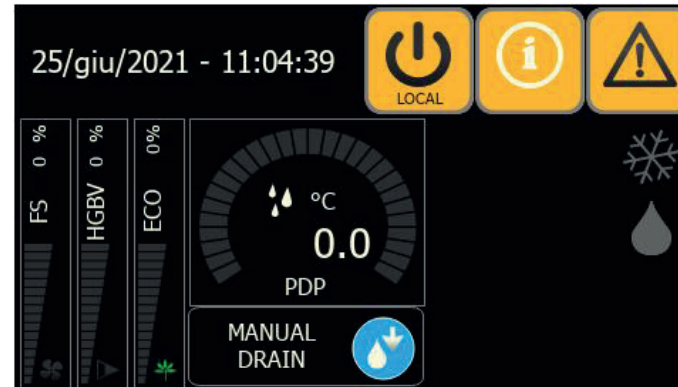

- c) Turn the MAIN SWITCH “” to “O OFF” to switch the power off.

 Wc version, close the water circuit with the dryer stopped.







5 Control

5.1 Home screen



Touch buttons	Function	
	Touch ON/OFF	 OFF (gray)
		 ON (verde)
	Local	Remote
	Access to information menu: machine status, pressures, temperatures, general settings, consumption, user password	
	Access to alarm menu: alarms/warnings and historical alarm.	
	Dryer OFF = grey light Cycling active = flashing green Compressor active = light blue	

other information

	Fan operation rate (only for air condenser version)		Hot gav valve operation rate		Energy saving % (cycling)
	Dew point trend		Shows the ON/OFF drain		
			Touch: for a manual drain		

5.2 Main menu

Touch  to enter on “Information” menu:

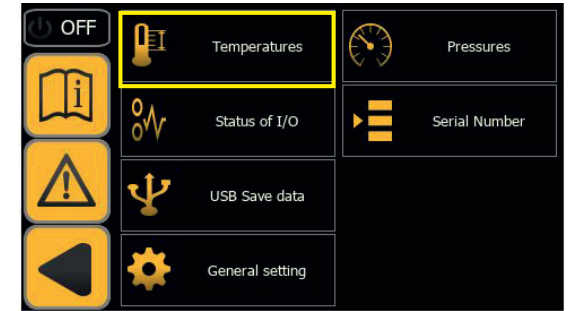

When one of the “touch buttons” is touched, for a few seconds the outline lights up to confirm that the selection has been made.

This is for each “touch button” present on the control panel.

Touch  to return to control panel.

5.2.1 Machine status (I/O)

Touch  to enter on “machine status” menu.
This is the list of inputs:

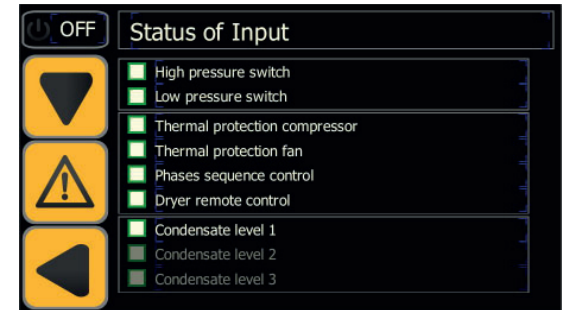

A led, close the description, indicates if the protections / functions / configurations is:

active = green light
no active = grey light.

e.g .

touch  to enter on the next page.

This is the list of outputs:

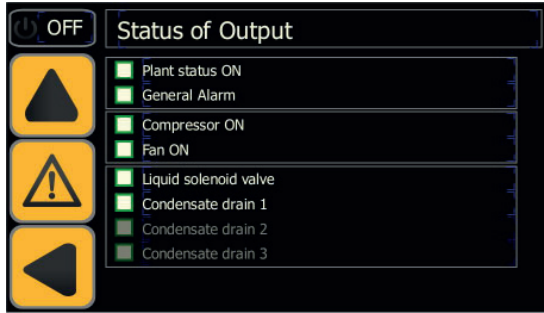

Touch to return to the previous menu.

5.2.2 Pressure

Touch to enter on "pressure" menu to visualize: condensing pressure, fan operating rate, evaporating pressure, hot gas valve operating rate.

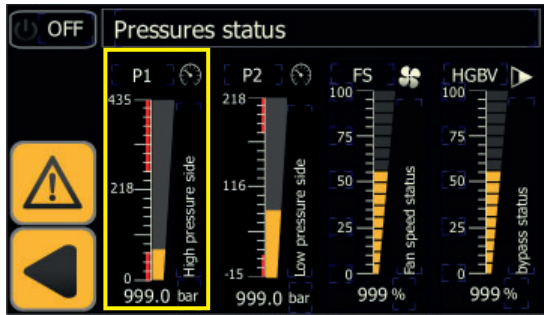

Use the "button touch" to see the graphic of the component.
e.g. "Condensing/Evaporating pressure"

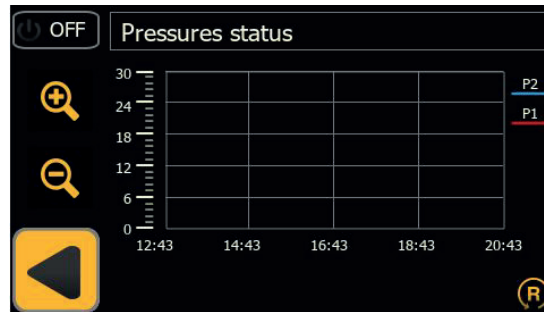

use and to scroll on the graph.

e.g. "Hot gas valve/fan operating rate"

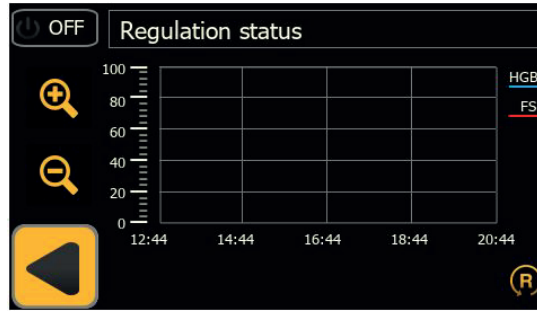

use and to scroll on the graph.

Touch to return to the previous menu.

Touch to return to control panel.

5.2.3 Temperature

Touch to visualize temperature readings by the temperature probes of the circuit diagram.

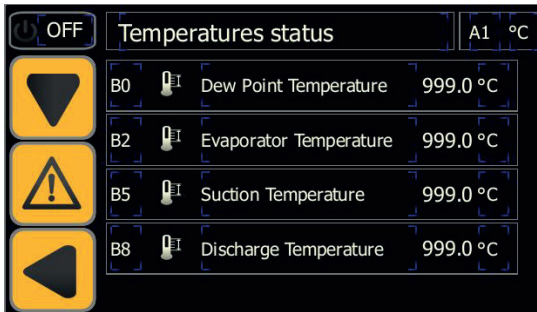

touch to enter on the next page.

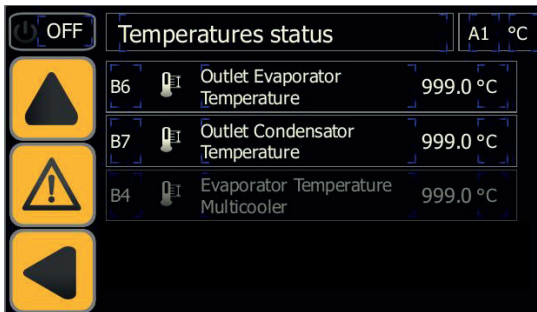

B4 = active only for multicooler version

use the "touch button" of one of the low pressure temperatures to see the graph of all the probes in the low pressure circuit diagram

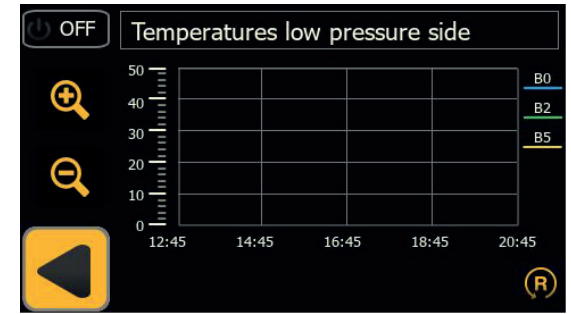

use and to scroll on the graph.

use the "touch button" of one of the high pressure temperatures to see the graph of all the probes in the high pressure circuit diagram

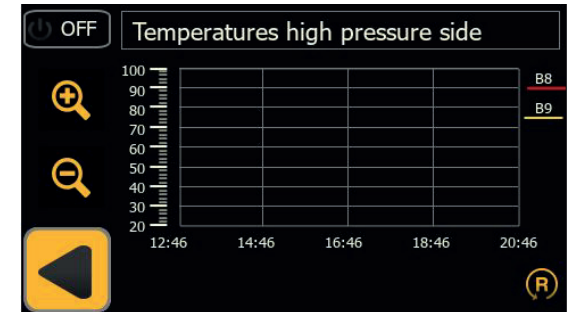

use and to scroll on the graph.

Touch to return to the previous menu.

5.2.4 General

Touch to enter on "general" menu with the following section: language; date/hour; parameter ; maintenance; cycling/continuous operating.

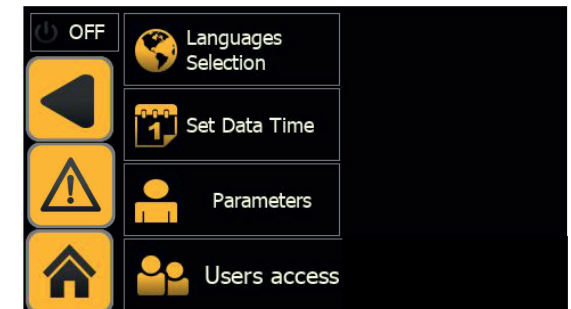

touch the "button touch" to enter on menu.

Touch to return to control panel.

5.2.4.1 Language

Touch  to enter on language menu



touch the language you need.
Automatically you return to the main menu with the chosen language.

5.2.4.2 Date/Time

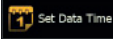
Touch  to enter on "date/time" menu

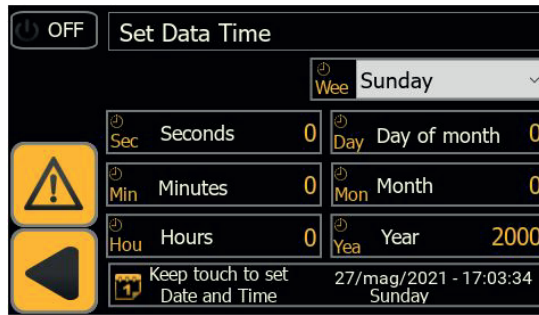

Touch Date/Time to proceed with the change.

Press for 2 seconds  to confirm.

Touch  to return to the previous menu.

Touch  to return to control panel.

5.2.4.3 Parameter

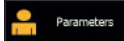
Touch  to enter on "parameter" menu with the following sections: probes, condensate drain, configuration, maintenance, cycli...

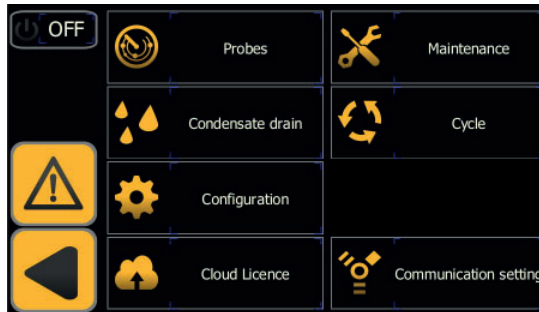

touch the "button touch" to enter on menu.

Touch  to return to control panel.

Probes

Touch  to set the warnings and delays or the minimum/maximum of dew point.

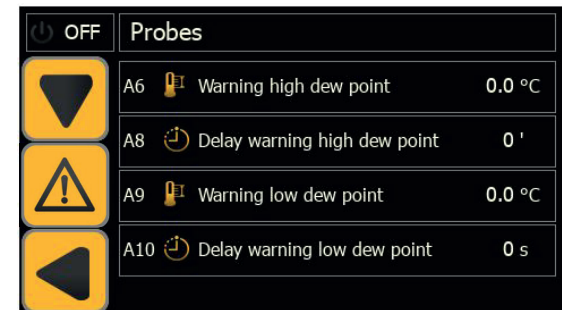

Condensate drain

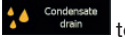
Touch  to enter on the menu "condensate drain"



it is possible to choose:
timed drain (choosing the closing and opening times);
capacitive drain;
contiuonous drain (external drain).

Touch  to return to the previous menu.

Configuration

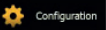
Touch  to enter on configuration display with the following menu:

- choice of temperature degree C° / F°;
- enabling remote control;
- enabling only alarms or alarms / warnings;
- reset the settings with the default parameters.

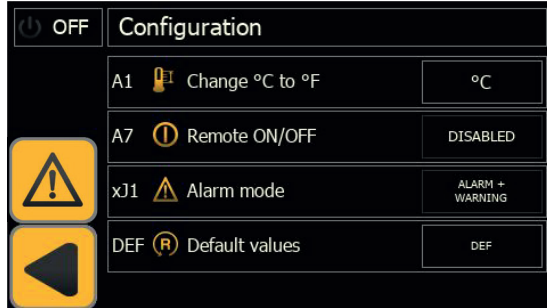



use the “button touch” close to the description to make your choice.

Touch  to return to the previous menu.

Maintenance

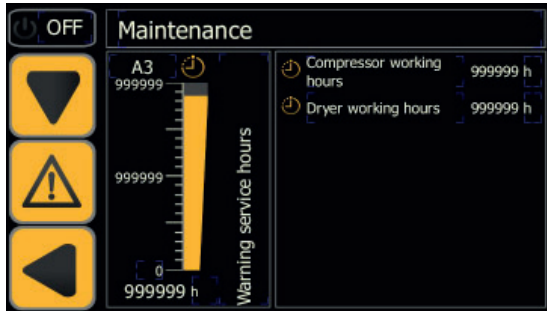
Touch  to see the work hours compressor/dryer.



Touch  to return to the previous menu.

Operating

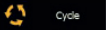
Touch  to choose the type of operating : continuous; cycling (energy saving).

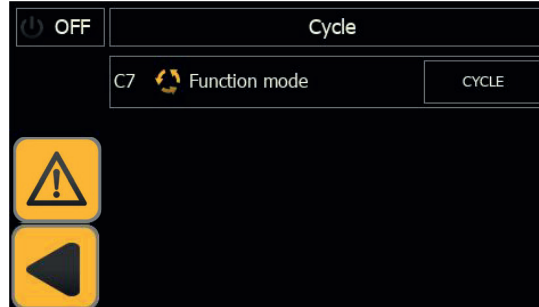



use the “button touch” close to the description to make your choice.

Touch  to return to the previous menu.

Cloud

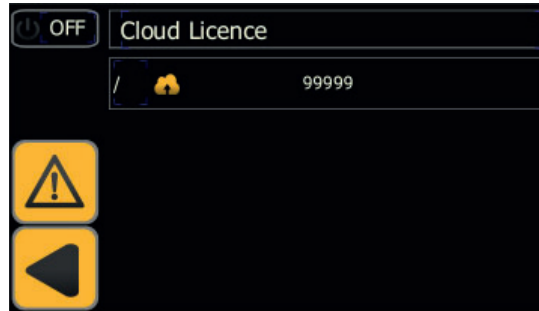
Touch  to see “password” to cloud.



Touch  to return to the previous menu.

Modbus

Touch  to set the Modbus parameters.

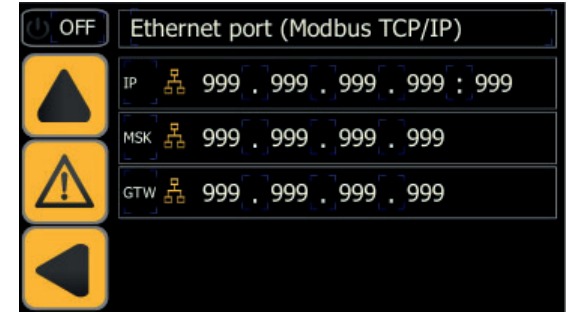
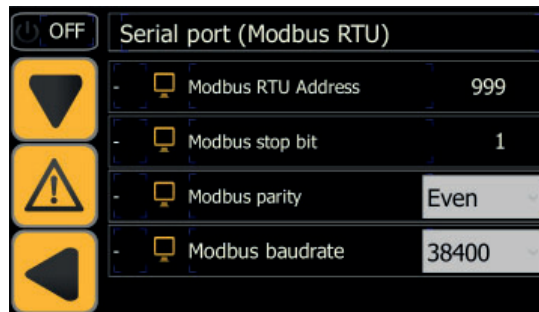

Touch  to return to the previous menu.

5.2.5 Serial number date

Touch  to enter on “serial number date” window.

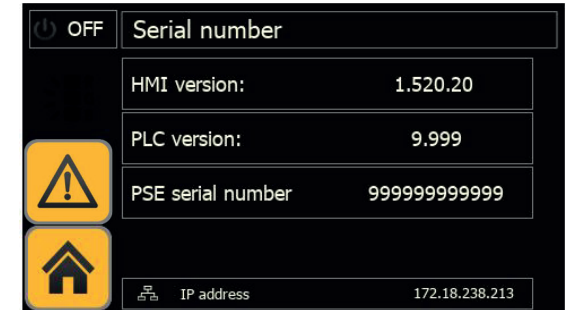

Touch  to return to control panel.

5.2.6 Download

Touch  to proceed with the download of the graphics of the temperatures and pressures. Use a USB with led , that show you the downloading phase.

Touch  to return to control panel.

5.3 Alarms/warnings

Touch  to enter on “alarms/warning” menu:

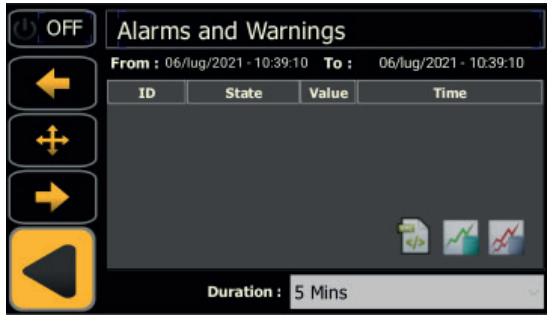

Touch “duration” to change the time of research.

Touch  to return to the previous menu.

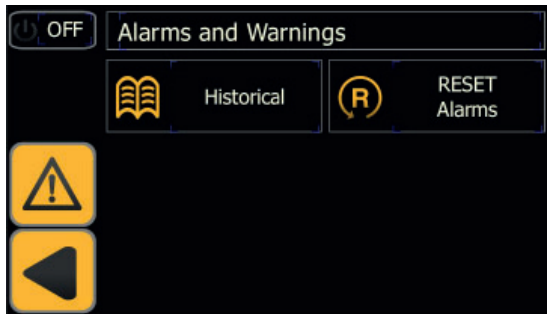

When the nominal working conditions have been restored, some warning and alarm are automatically reset, for other alarms/warning it is necessary to perform a manual reset.

Touch  to reset the alarm

Touch  to visualize the historical alarms with: the alarm code, the date, the number of alarms, the position in the sequence of occurrence, and the alarm activation time.

Touch  to return to control panel.

5.3.1 List of alarms/warnings

a = alarm





w = warning

aLD	low dew point alarm	temperature B0<A9 for more than A10 seconds.
aLT	low evaporator temperature alarm	temperature B2<A12 for more than A13 seconds
aHT2	high discharge temperature alarm	temperaure B8>A11
aHP	high pressure alarm	high pressure switch is tripped
aLP	low pressure alarm	low pressure switch is tripped
aLTA	low multicooter temperature alarm	temperature B4<A12 for more than A13 seconds
aPI	Compressor thermal protection alarm	compressor thermal protection is tripped
aPH	phase monitoring alarm	phase monitoring relay is tripped
aCM1	communication expansion 1 alarm	the expansion 1 is not communicating
aCM2	communication expansion 2 alarm	the expansion 2 is not communicating
wB0	warning probe B0	probe broken or not connected
wB2	warning probe B2	probe broken or not connected
wB4	warning probe B4	probe broken or not connected
wB5	warning probe B5	probe broken or not connected
wB6	warning probe B6	probe broken or not connected
wB8	warning probe B8	probe broken or not connected
aFP1	high pressure transmitter P1 alarm	transmitter broken or not connected
wHD	high dew point warning	temperature B0>A6 for more than A8 minutes
wHT1	high discharge temperature warning	temperature B8>A14 for more than A15 minutes
wHP1	high pressure warning	pressure P1>A16 for more than 2 seconds
wHB5	high suction temperature warning	temperture B5>A18 for more than 1 minute
wLP2	low pressure warning	pressure P2<A21 for more than 150 seconds
wSR	Scheduled maintenance warning	the service time is elapsed
wDR1	drain 1 warning	the condensate is not discharge from cooler 1
wDR2	drain 2 warning	the condensate is not discharge from cooler 2
wDR3	drain 3 warning	the condensate is not discharge from cooler 3
aFP2	low pressure transmitter P2 alarm	transmitter broken or not connected

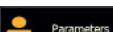

5.4 Rapid menu

Reach the menu in short steps:

Change of measurement unit from C° to F°

- Touch 
- Touch  General setting
- Touch  Parameters
- Touch  Configuration
- Touch the parameter “C°” or “F°” for make the change

Change Local/rOFF

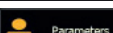
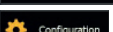
- Touch 
- Touch  General setting
- Touch  Parameters
- Touch  Configuration
- Enable / disable the parameter “Remote ON/OFF” .

View the temperature

- Touch 
- Touch  Temperatures
- Touch the temperature to see the graphs.



View the pressure

- Touch 
- Touch  Pressures
- Touch the pressure to see the graphs.

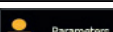
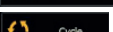
Switch to “cycling” operation

- Touch 
- Touch  General setting
- Touch  Parameters
- Touch  Cycle
- change the operation.

Change language



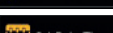

- Touch 
- Touch  General setting

- Touch  Languages Selection
- choose your language



Date/Time

- Touch 
- Touch  General setting
- Touch  Set Data Time
- update clock



Drain

- Touch 
- Touch  General setting
- Touch  Parameters
- Touch  Condensate drain
- choose your drain.

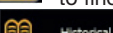
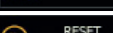
Alarm / warning

- Touch 
- Touch  to find historical alarm and reset alarm
- Touch  Historical to see your historical alarm.
- Touch  RESET Alarms to reset alarm.

Serial number date

- Touch 
- Touch  Serial Number

Setting parameter





- Touch 
- Touch  General setting
- Touch  Parameters
- Touch  Probes
- change the parameter.

Download

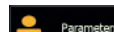

- Insert your USB
- Touch 

- Touch  for the download.

Cloud

- Touch 
- Touch  General setting
- Touch  Parameters
- Touch  Cloud Licence

Modbus

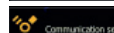
- Touch 
- Touch  General setting
- Touch  Parameters
- Touch  Communication setting

Restore default parameters

- Touch 
- Touch  General setting
- Touch  Parameters
- Touch  Configuration
- Touch “DEF” to restore the parameter.

6 Maintenance

- a) The machine is designed and built to guarantee continuous operation; however, the life of its components depends on the maintenance performed.
- b) When requesting assistance or spare parts, identify the machine's model number and serial number (located on the unit's serial label) and provide to Parker or an authorized Parker distributor.
- c) Circuits containing 5t < xx < 50t of CO₂ should be checked annually to identify any potential leaks.
Per European Regulation EU No. 517/2014 art. 4.3.a, 4.3.b) - Circuits containing 50t < xx < 50t of CO₂ should be checked for leaks every 6 months.
- d) Per European Regulation EU No. 517/2014 art. 6 - Machines containing 5t CO₂ or more, the operator must keep a written record of the quantity and type of refrigerant used, added or recovered during maintenance/repair and final disposal.

6.1 General instructions

-  Before any maintenance, make sure:
- the pneumatic circuit is no longer pressurized;
 - the dryer is disconnected from the main power supply

 Always use the Manufacturer's original spare parts: otherwise the Manufacturer is relieved of all liability regarding machine malfunctioning.

 In the event of refrigerant leakage, contact qualified and authorized personnel.

 The Schrader valve must only be used in case of machine malfunction: otherwise any damage caused by incorrect refrigerant charging will not be covered by the warranty.

6.2 Refrigerant.















 Charging: any damage caused by incorrect refrigerant replacement carried out by unauthorized personnel will not be covered by the warranty.

 The equipment contains fluorinated greenhouse gases. At normal temperature and pressure, the R513A refrigerant is a colorless gas classified in SAFETY GROUP A1 - EN378 (group 2 fluid according to Directive PED 2014/68/EU)
GWP (Global Warming Potential) = 573.

 In the event of refrigerant leakage, ventilate the room.

6.3 Preventive Maintenance Programme

To maximize the machines efficiency, reliability and longevity follow the preventative maintenance guide below:

Maintenance Activity Description	Maintenance Interval (standard operating conditions)				
	Daily	Weekly	4 Months	12 Months	36 Months
<p>Activity</p> <p>Check  Service </p>					
Check POWER ON indicator is lit.					
Check control panel indicators.					
Clean the filter of the water pressostatic valve, if it is not dirty increase the inspection interval (see instructions) (PSE750-1800)					
Check condensate drain.					
Clean condenser fins.					
Verify that the crankcase heater is correctly positioned					
Check electrical absorption.					
Check refrigerant leaks.					
Depressurize the dryer. Complete drain maintenance.					
Depressurize the dryer. Replace pre- and post-filter elements.					
Check temperature sensors. Replace if necessary.				 	
Dryer maintenance kit.					



The following are available (see par. 8.4):

- a) 3 years preventive maintenance kits;
- b) service kit for:
- compressor;
 - fan;
 - hot gas valve;

- water condenser;
- c) individual spare parts.

6.4 Dismantling

The refrigerant and the lubricating oil contained in the circuit must be recovered in conformity with current local environmental regulations. The refrigerant fluid is recovered before final scrapping of the equipment ((EU) No. 517/2014 art.8).

	Recycling Disposal 
structural work	steel/epoxy-polyester resins
exchanger	aluminium
pipes/headers	copper/aluminium/carbon steel
drain	polyamide
exchanger insulation	EPS (sintered polystyrene)
pipe insulation	synthetic rubber
compressor	steel/copper/aluminium/oil
condenser	copper/aluminium
refrigerant	R513A
valves	brass
electrical cables	copper/PVC

Índice





1 Seguridad	1
1.1 Importancia del manual	1
1.2 Señales de advertencia.....	1
1.3 Instrucciones de seguridad.....	1
1.4 Riesgos residuales:	1
2 Introducción	2
2.1 Transporte	2
2.2 Traslado.....	2
2.3 Inspección.....	2
2.4 Almacenaje.....	2
3 Instalación	2
3.1 Modalidades	2
3.2 Espacio operativo	2
3.3 Tipos de condensador	2
3.4 Entorno de instalación	2
3.5 Conexiónado eléctrico.....	2
3.6 Conexión del drenaje de condensados	2
4 Puesta en Marcha	2
4.1 Comprobaciones previas	2
4.2 Arranque	2
4.3 Funcionamiento	3
4.4 Parada.....	3
5 Control	3
5.1 Panel de control	3
5.2 Menú principal	3
5.2.1 Estado del aparato (I/O)	3
5.2.2 Presión	4
5.2.3 Temperatura	4
5.2.4 General.....	4
5.2.4.1 Idioma	5
5.2.4.2 Fecha/Tiempo	5
5.2.4.3 Parámetro.....	5
5.2.4.4 Fecha del número de serie	6
5.2.6 Descarga	6
5.3 Alarmas/advertencias	7
5.4 Lista de alarmas y avisos.....	7
5.5 Menú rápido	8
6 Mantenimiento	9
6.1 Advertencias generales.....	9
6.2 Refrigerante.....	9
6.3 Programa de mantenimiento preventivo.....	9
6.4 Desguace	9
7 Solución de problemas	10
8 Apéndice	

1 Seguridad

1.1 Importancia del manual

- Consérvelo durante toda la vida útil del equipo.
- Léalo antes de realizar cualquier operación.
- Parker se reserva el derecho a realizar cambios en este manual del usuario, consulte la versión instalada en el equipo.

1.2 Señales de advertencia



	Instrucción para evitar peligros personales
	Instrucción para evitar que se dañe el equipo
	Se requiere la intervención de un técnico experto y autorizado
	El significado de los símbolos utilizados se indica en el apartado 8.

1.3 Instrucciones de seguridad

 Antes de realizar cualquier operación de mantenimiento, desconecte siempre la máquina de la red eléctrica. Utilícelo siempre durante el mantenimiento.

 Este manual de usuario está destinado a ayudar tanto al usuario final como al técnico de servicio. Solo un técnico capacitado y calificado debe quitar los paneles para realizar el servicio.

 No supere los límites de proyecto que se indican en la placa de características.

  El usuario debe evitar cargas distintas de la presión estática interna. En caso de riesgo de fenómenos sísmicos, es necesario proteger adecuadamente la unidad..

 Todos los dispositivos de seguridad para el circuito de aire comprimido deben ser proporcionados por el usuario y deben seleccionarse de acuerdo con las especificaciones del sistema y de acuerdo con la legislación local.

La unidad debe utilizarse exclusivamente para uso profesional y con el objeto para el cual ha sido diseñada.

El usuario debe analizar todos los aspectos de la aplicación en que el producto se ha instalado, seguir todas las normas industriales de seguridad aplicables y todas las prescripciones relativas al producto descritas en el manual de uso y en la documentación redactada que se adjunta a la unidad.

La alteración o sustitución de cualquier componente por parte del personal no autorizado, así como el uso inadecuado de la unidad eximen de toda responsabilidad al fabricante y provocan la anulación de la garantía.

El fabricante declina toda responsabilidad presente o futura por daños personales o materiales derivados de negligencia del personal, incumplimiento de las instrucciones dadas en este manual o inobservancia de las normativas vigentes sobre la seguridad de la instalación.

El fabricante no asume ninguna responsabilidad por daños debidos a alteraciones y/o modificaciones del embalaje.

El usuario es responsable que las especificaciones suministradas para seleccionar la unidad o sus componentes y/o opciones sean exhaustivas para un uso correcto o razonablemente previsible de la misma unidad o de los componentes.

 **ATENCIÓN: El fabricante se reserva el derecho de modificar sin previo aviso la información de este manual. Para que la información resulte completa, se recomienda al usuario consultar el manual a pie de máquina.**

1.4 Riesgos residuales:

Las operaciones de instalación, puesta en marcha, apagado y mantenimiento del equipo deben realizarse de total conformidad con lo indicado en la documentación técnica del equipo y de manera tal que no se genere ninguna situación de riesgo. Los riesgos que no han podido eliminarse con recursos técnicos de diseño se indican en la tabla siguiente

parte del equipo	riesgo residual	modo	precauciones
batería de intercambio térmico	pequeñas heridas cortantes	contacto	evitar el contacto, usar guantes de protección
rejilla del ventilador y ventilador	lesiones	introducción de objetos puntiagudos en la rejilla mientras el ventilador está funcionando	no introducir ni apoyar ningún objeto en la rejilla de los ventiladores
interior del equipo: compresor y tubo de salida	quemaduras	contacto	evitar el contacto, usar guantes de protección
interior del equipo: partes metálicas y cables eléctricos	intoxicación, electrocución, quemaduras graves	defecto de aislamiento de los cables de alimentación que llegan al cuadro eléctrico del equipo; partes metálicas en tensión	protección eléctrica adecuada de la línea de alimentación; conectar cuidadosamente a tierra las partes metálicas
exterior del equipo: zona circundante	intoxicación, quemaduras graves	incendio por cortocircuito o sobrecalentamiento de la línea de alimentación del cuadro eléctrico del equipo	sección de los cables y sistema de protección de la línea de alimentación eléctrica conformes a las normas vigentes

2 Introducción

Este manual hace referencia a los secadores de refrigeración Parker PSE1400-6000 diseñados para eliminar el vapor de agua del aire comprimido.

2.1 Transporte

El equipo embalado debe mantenerse:

- en posición vertical;
- protegido de los agentes atmosféricos;
- protegido de golpes.

2.2 Traslado

Utilice una carretilla elevadora con horquillas, adecuada para el peso del equipo, y evite todo tipo de golpes.

2.3 Inspección

- Los equipos salen de fábrica ensamblados, cableados, cargados con refrigerante y aceite, y probados en las condiciones de trabajo nominales.
- Controle el equipo a su llegada y notifique inmediatamente al transportista si nota algún inconveniente.
- Para evitar manipulaciones innecesarias de la secadora, desembale el equipo lo más cerca posible del lugar de instalación.

2.4 Almacenaje

Si es necesario apilar, siga las instrucciones indicadas en el paquete. Mantenga la unidad empaquetada en un área limpia y seca que esté protegida de los elementos, la luz solar directa y / u otras condiciones adversas.

3 Instalación

☞ Solo personal competente capacitado, calificado y aprobado por Parker debe realizar los procedimientos de instalación, puesta en servicio, servicio y reparación. Tenga cuidado cuando esté cerca de la secadora y use el equipo de protección adecuado.

⚠ Si se instala en un lugar con peligro de incendio, proporcione un sistema de extinción de incendios adecuado. El producto instalado debe estar protegido contra el riesgo de incendio. (ref. EN378-3).

3.1 Modalidades

Instale en interiores en un área limpia y seca que esté protegida de los elementos, la luz solar directa y / u otras condiciones adversas.

☞ Respete las indicaciones dadas en los apartados 8.2 y 8.3.

Para una operación confiable y propósitos de garantía, se recomienda una filtración previa adecuada. Sin una prefiltración, la secadora puede ver una degradación en el rendimiento y / o una falla permanente de la secadora. La garantía se anulará si la calidad del aire de entrada no cumple con la Clase ISO8573-1 requerida para partículas y aceite total. El vendedor está excluido de cualquier obligación de compensación o reembolso por los daños directos o indirectos causados por su ausencia.

☞ El elemento de prefiltro debe ser sustituido al menos una vez al año

o antes, según las recomendaciones del fabricante.

☞ Conecte correctamente el secador a las conexiones de entrada / salida de aire comprimido utilizando una tubería o manguera que cumpla con los requisitos de temperatura y presión de la salida del compresor de aire. (vea el apartado 8.3 y 8.6).

3.2 Espacio operativo

☞ Deje un espacio libre de 5 ft (1.5 m) todo alrededor del equipo. En los modelos con expulsión vertical del aire de condensación, deje 6.5 ft (2 m) libres sobre el secador.

3.3 Tipos de condensador

Versión refrigerada por aire (Ac)

Tipo de condensador estándar para todos los modelos PSE. Nota: No conduzca, cree situaciones de recirculación de aire de refrigeración ni obstruya las rejillas de ventilación.

Versión refrigerada por agua (Wc)

Versión refrigerada por agua (Wc): Nota: Se recomienda instalar un filtro de malla en la entrada de agua de refrigeración (no se incluye con PSE como estándar)

☞ Características del agua de condensación utilizada:

Temperatura	≥50°F (10°C)	CL-	<50 ppm
ΔT IN/OUT	41°-59°F 5-15°C	CaCO3	70-150 ppm
Max % de glicol	50	O2	<0.1 ppm
Presión	43.5-145 PSig (3-10 barg)	Fe	<0.2 ppm
PH	7.5-9	NO3	<2 ppm
Conductividad eléctrica	10-500 μS/cm	HCO3-	70-300 ppm
Índice de saturación de Langelier	0-1	H2S	<0.05 ppm
SO42-	<50 ppm	CO2	<5 ppm
NH3	<1 ppm	Al	<0.2 ppm

Nota: Para tipos especiales de agua de refrigeración, como desmineralizada, desionizada o destilada, es necesario ponerse en contacto con el fabricante para verificar si el condensador PSE estándar es adecuado.

3.4 Entorno de instalación

El secador PSE se deben instalar solo en interiores. A fin de proteger los componentes internos del secador y del compresor de aire, no instale el equipo donde el aire circundante contenga contaminantes sólidos o gaseosos, en particular azufre, amoníaco y cloro. Evite también la instalación en ambiente marino.

En las versiones con ventiladores axiales, se desaconseja canalizar el aire agotado.

3.5 Conexión eléctrico

Utilice un cable homologado con arreglo a las reglamentaciones locales (para la sección mínima del cable, vea el apartado 8.3). Instale un interruptor magnetotérmico diferencial aguas arriba del equipo (RCCB - IDn = 0,3 A) con distancia 0.12in (3 mm) entre los contactos cuando el interruptor está abierto (consulte las disposiciones locales al respecto).

La corriente nominal "In" de dicho magnetotérmico debe ser igual a FLA y la curva di intervención de tipo D.

Seleccione la fuente de alimentación e inserte un puente como se muestra a continuación:

S7-S6 por 400/3/50

S8-S6 por 460/3/60

Dentro del cuadro eléctrico hay una etiqueta de instrucciones.

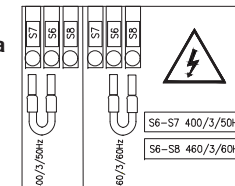

3.6 Conexión del drenaje de condensados

☞ Para conectar el equipo al sistema de drenaje, evite la conexión en circuito cerrado en común con otras líneas de descarga presurizadas. Asegúrese de que la descarga de condensado sea adecuada. Deseche los condensados con arreglo a las normas medioambientales vigentes.

4 Puesta en Marcha

4.1 Comprobaciones previas

Antes de poner en marcha el secador, asegúrese de que:

- Toda la información de la sección 3 fue leída, comprendida y ejecutada correctamente;
- las válvulas de entrada del aire están cerradas y salida de aire comprimido están cerradas y no fluye aire a través del secador;
- el suministro eléctrico es correcto;
- Nota: Si usa una versión Wc, abra el circuito de agua de enfriamiento 5 minutos antes de encender la secadora.

4.2 Arranque



a) encienda la alimentación girando el INTERRUPTOR PRINCIPAL

☞ a "I ON":

⚠ **LA RESISTENCIA DEL CÁRTER DEBE ACTIVARSE 12 HORAS ANTES DE PONER EN MARCHA EL SECADOR.**

	EN - THE CRANKCASE HEATER MUST BE SWITCHED ON 12 HOURS BEFORE STARTING THE DRYER.
	IT - LA RESISTENZA CARTER DEVE ESSERE INSERITA 12 ORE PRIMA DI AVVIARE L'ESSICCATORE.
	FR - LA RESISTANCE CARTER DOIT ETRE BRANCHEE 12 HEURES AVANT LA MISE EN MARCHÉ DU SECHÉUR.
	DE - DIE VERSORGUNG DER KURBELWANNENHEIZUNG IST 12 STUNDEN VOR DER EINSCHALTUNG DES TROCKNERS FREIZUGEBEN.

toque por volver al panel de control

b) toque  para arrancar, el botón cambia de atenuado a verde, para indicar que ahora el secador está en funcionamiento .

El incumplimiento de esta regla puede causar daños graves al compresor.

c) Encienda el secador antes que el compresor de aire;

 Ventiladores (versión Ac): si están conectados con la secuencia de fase incorrecta, girarán en dirección opuesta con riesgo de dañarse (en este caso el aire saldrá del armario del secador por las rejillas del condensador en vez de por la rejilla del ventilador - consulte el párr. 8.6 y 8.7 para el flujo de aire correcto); invierta inmediatamente las dos fases.

d) Espere 5 minutos, luego abra lenta y parcialmente la válvula de entrada. Deje que la secadora alcance la presión de la línea antes de abrir completamente la válvula de entrada.

e) Una vez que el secador esté a presión de línea y la válvula de entrada esté completamente abierta, abra lentamente la válvula de salida de aire; el secador ahora se está secando.

Monitor de fase

Si aparece la alarma "Monitor de fase" en la pantalla durante el arranque del secador, el usuario deberá revisar el cableado de los terminales de entrada del interruptor de desconexión del secador.

4.3 Funcionamiento

a) Deje siempre la secadora encendida cuando el compresor esté encendido y funcionando.

b) El secador funciona en modo automático, por lo que no es necesario realizar ajustes de campo constantes. Consulte la sección 5 para conocer los controles de navegación.

c) En caso de producirse flujos de aire excesivos e inesperados, haga una derivación para no sobrecargar el secador.

d) Evite las fluctuaciones de temperatura en el aire de entrada.

4.4 Parada

Detenga el compresor o el flujo de aire a través de la secadora y espere 2 minutos antes de apagar el secador;

Cierre la válvula de entrada de aire para asegurarse de que el aire comprimido no ingrese en el secador cuando se desconecta o si ocurre una alarma.

e) Pulse  para apagar el secador.

El botón cambia de color de verde a gris. 





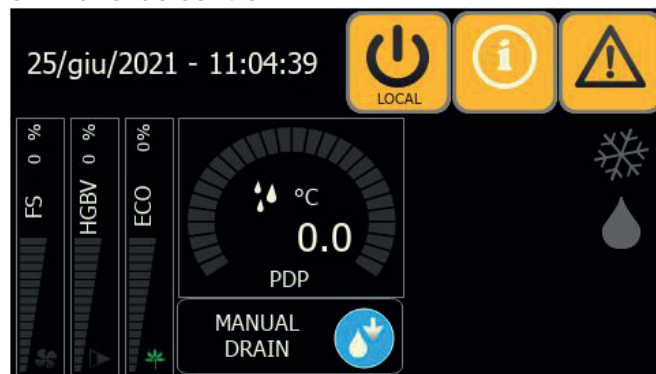

f) Gire el INTERRUPTOR PRINCIPAL "  " a "O OFF" para desconectar la alimentación.

 Versión Wc: cierre el circuito de agua con el secador apagado.

5 Control



5.1 Panel de control



Botones táctiles	Función	
	Tocar ON/OFF	 OFF (atenuado)
		 ON (verde)
	Locale	Remoto
	Acceso al menú de información: estado del aparato, presiones, temperaturas, ajustes generales, consumo, contraseña del usuario	
	Acceso al menú de alarmas: alarmas/advertencias e historial de alarmas.	
	Dryer OFF = luz gris Cycling activo = verde intermitente Compressor activo = luz blue	

información adicional

	Velocidad de funcionamiento del ventilador (solo para la versión con condensador de aire)		Velocidad de funcionamiento de la válvula de gas caliente		ahorro de energía % (ciclos)
---	---	---	---	---	------------------------------

	Tendencia de punto de condensación		Muestra el estado ON/OFF de la descarga Toque: para un drenaje manual
---	------------------------------------	---	--

5.2 Menú principal

Toque  para acceder al menú de "Información":

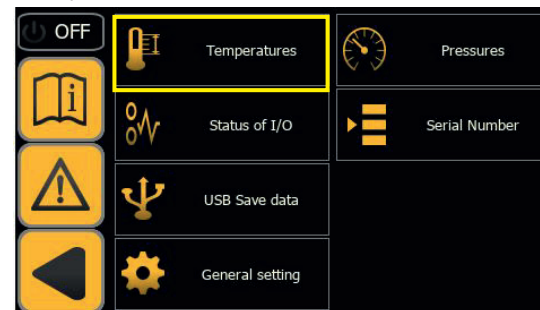

Cuando se toca uno de los "botones táctiles", durante unos segundos se ilumina el contorno para confirmar que se realizó la selección.

Esto se aplica a cada "botón táctil" presente en el panel de control.

Toque  para volver al panel de control.

5.2.1 Estado del aparato (I/O)

Toque  para acceder al menú de "estado del aparato". Esta es la lista de entradas:

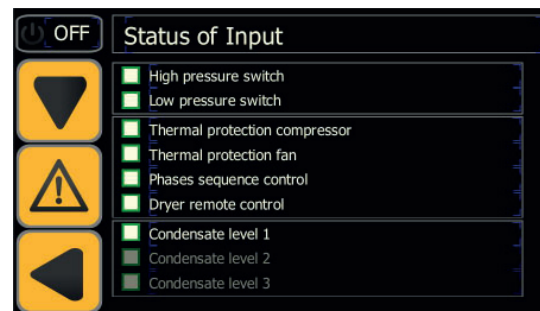

Un LED al lado de la descripción indica lo siguiente sobre las protecciones / funciones / configuración:
activo = luz verde
inactivo = atenuado.

Toque  para acceder a la siguiente página.

Esta es la lista de salidas:

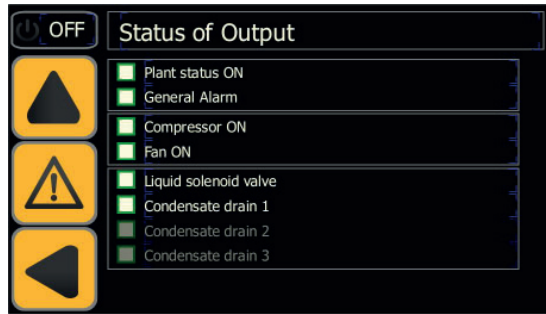

Toque para volver al menú anterior.

5.2.2 Presión

Toque para acceder al menú de “presión” y visualizar lo siguiente: presión de condensación, velocidad de funcionamiento del ventilador, presión de evaporación, velocidad de funcionamiento de la válvula de gas caliente.

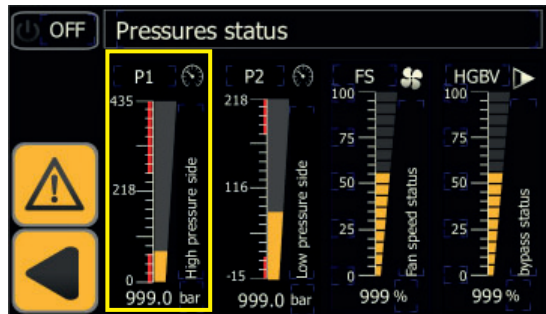

Toque em um parâmetro específico para visualizar sua tendência de dados de desempenho ao longo do tempo.

Por ej., “Presión de condensación/evaporación”

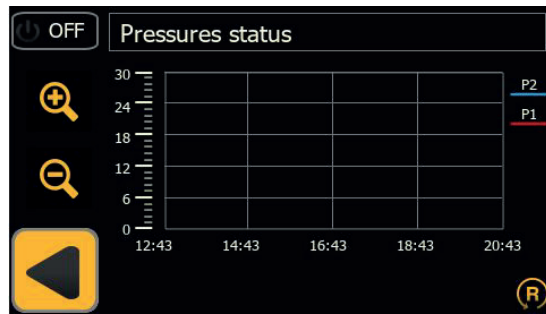

Utilice y para desplazarse por el gráfico.

Por ej., “Velocidad de funcionamiento de la válvula de gas caliente/ventilador”

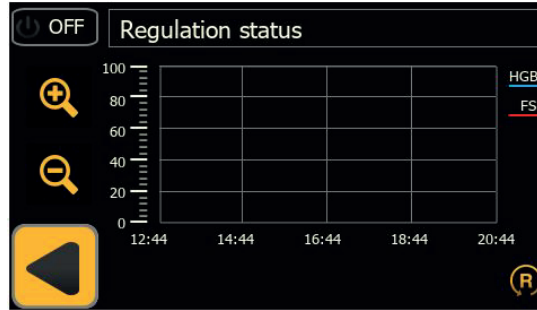

Utilice y para desplazarse por el gráfico.

Toque para volver al menú anterior.

Toque para volver al panel de control.

5.2.3 Temperatura

Toque para visualizar las lecturas de temperatura de las sondas de temperatura del diagrama de circuito.

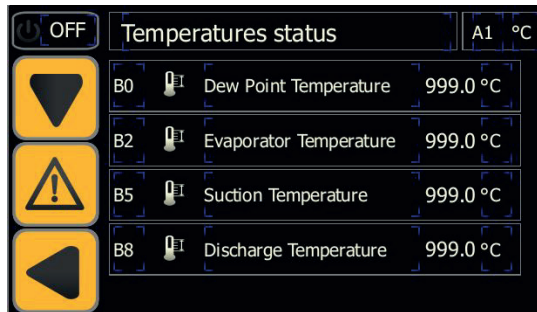

Toque para acceder a la siguiente página.

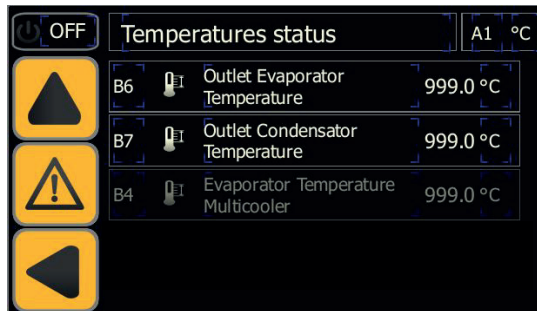

B4 = Activa solo para la versión Multicooler.

Toque em um dos valores de temperatura de baixa pressão para ver uma tendência de dados de todas as sondas no circuito de baixa pressão.

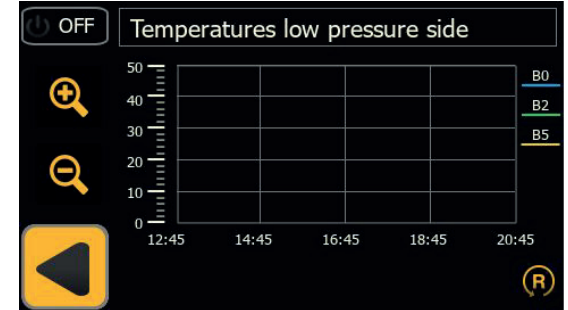

Utilice y para desplazarse por el gráfico.

Toque em um dos valores de temperatura de alta pressão para ver una tendencia de datos de todas las sondas no circuito de alta presión.

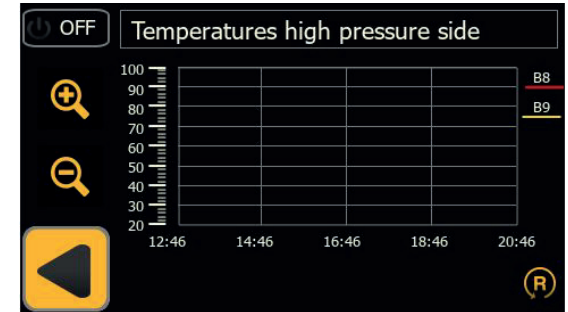

Utilice y para desplazarse por el gráfico.

Toque para volver al menú anterior.

5.2.4 General

Toque para acceder a un menú “general” con las siguientes secciones: idioma; fecha/hora; parámetro; mantenimiento; ciclos/funcionamiento continuo.

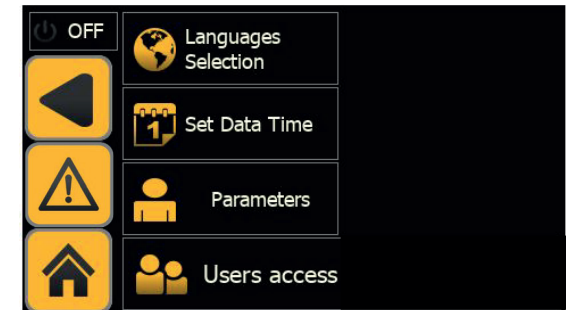

toque em qualquer menú para visualizar / ajustar.

Toque  para volver al panel de control.

5.2.4.1 Idioma

Toque  para acceder al menú de idioma.



Toque en el idioma que necesite.
Volverá automáticamente al menú principal con el idioma que haya elegido.

5.2.4.2 Fecha/Tiempo

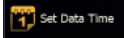
Toque  para acceder al menú de “fecha/tiempo”

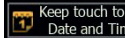

Toque Fecha/Tiempo para proceder con el cambio.

Presione durante 2 segundos  27/mag/2021 - 17:03:34 Sunday para confirmar.

Toque  para volver al menú anterior.

Toque  para volver al panel de control.

5.2.4.3 Parámetro

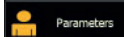
Toque  para acceder al menú de “parámetros” con las siguientes secciones: sondas, descarga de condensado, configuración, mantenimiento, ciclos.

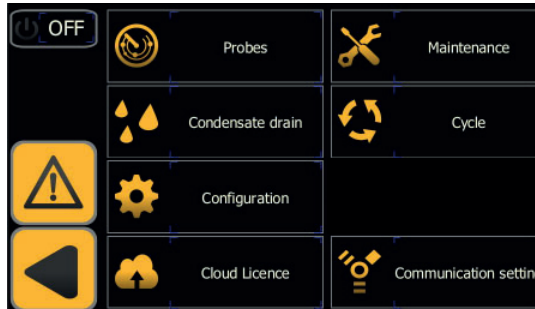

Toque el “botón táctil” para acceder al menú.

Toque  para volver al panel de control.

Sondas

Toque  para ajustar las advertencias, los retrasos o el límite mínimo/máximo del punto de condensación.

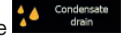

Descarga de condensado

Toque  para acceder al menú de “descarga de condensado”.

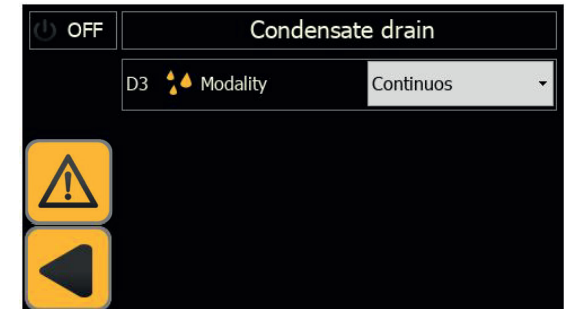

Puede elegir lo siguiente:
Descarga temporizada (selección de los tiempos de cierre y apertura);
Descarga capacitiva;
Descarga continua (externa).

Toque  para volver al menú anterior.

Configuración

Toque  para acceder a la pantalla de configuración con el siguiente menú:
 selección de la medida de temperatura °C / °F;
 activación del control remoto;
 activación solo de alarmas o de alarmas / advertencias;
 restablecimiento a los parámetros predeterminados.

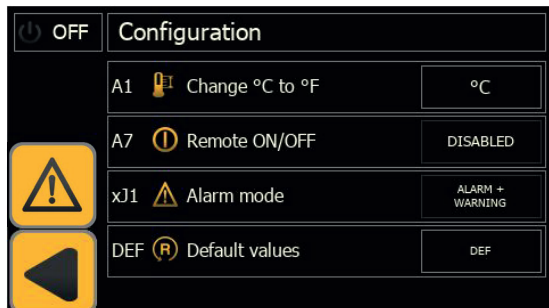

Utilice el “botón táctil” al lado de la descripción para seleccionar.

Toque  para volver al menú anterior.

Mantenimiento

Toque  para ver las horas de funcionamiento del compresor/ secador.

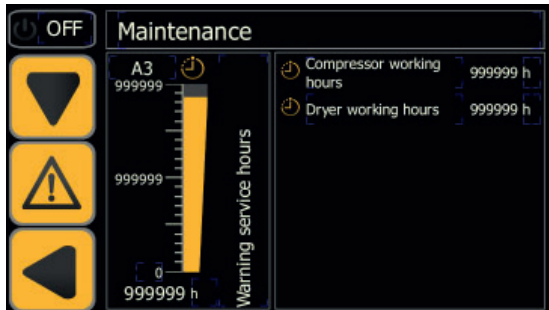

Toque  para volver al menú anterior.

Funcionamiento

Toque  para elegir el tiempo de funcionamiento: continuo; por ciclos (ahorro de energía).





Utilice el “botón táctil” al lado de la descripción para seleccionar.

Toque  para volver al menú anterior.

Cloud

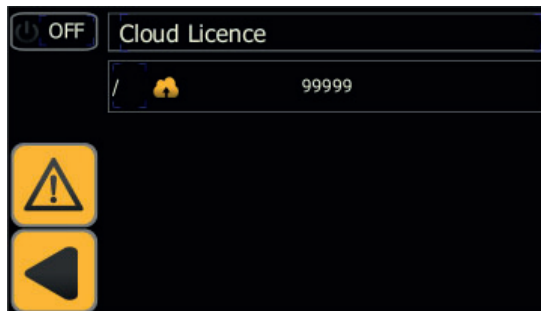
Toque  para ver “password” para cloud.



Toque  para volver al menú anterior.

Modbus

Touch  para configurar los parámetros de Modbus.

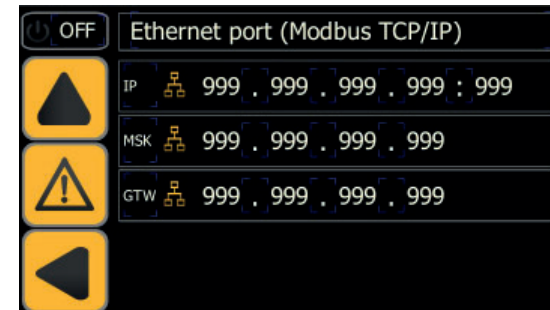
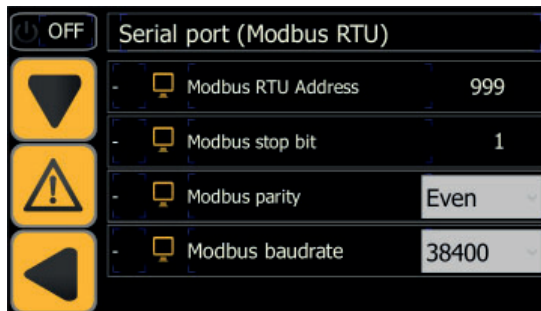

Toque  para volver al menú anterior.

5.2.5 Fecha del número de serie

Toque  para acceder al menú de “Serial number”.

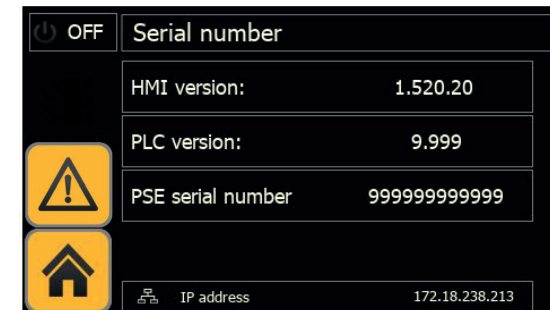

Toque  para volver al panel de control.

5.2.6 Descarga

Toque  para proceder con la descarga de los gráficos de temperaturas y presiones. Use um USB com led, que mostra a fase de download.

Toque  para volver al panel de control.

5.3 Alarmas/advertencias

Toque  para acceder al menú de “alarmas/advertencias”:

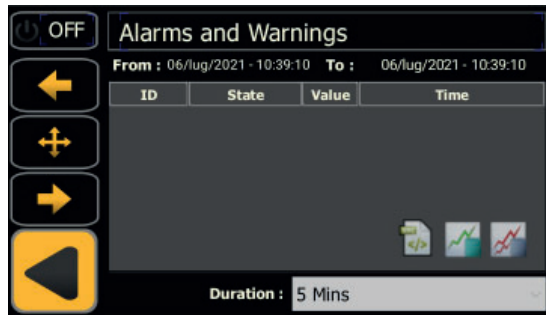

Toque “duration” para cambiar el tiempo de la investigación.

Toque  para volver al menú anterior.

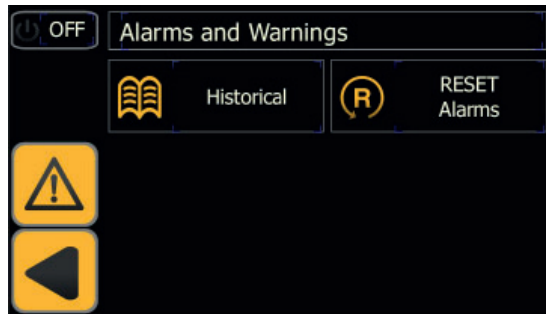

Cuando se han restablecido las condiciones de funcionamiento nominales, algunas advertencias y alarmas se reinician automáticamente; es necesario restablecer manualmente las demás alarmas/advertencias.

Toque  para reiniciar la alarma

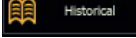
Toque  para ver el historial de alarmas con: código de alarma, fecha, número de alarmas, posición de la secuencia, y hora de activación de las alarmas.

Toque  para volver al panel de control.

5.4 Lista de alarmas y avisos

a = alarma



w = aviso

aLD	alarma Bajo punto de rocío	temperatura B0<A9 por más de A10 segundo .
aLT	alarma baja temperatura de evaporación	temperatura B2<A12 por más de A13 segundo
aHT2	alarma alta temperatura de descarga	temperatura B8>A11
aHP	alarma alta presión	presostato de alta presión activado
aLP	alarma baja presión	presostato de baja presión activado
aLTA	alarma baja temperatura multicooter	temperatura B4<A12 por más de A13 segundo
aPI	compressor thermal Protection alarm	thermal Protection compressor activado
aPH	alarma monitor de fase	monitor de fase activado
aCM1	alarma comunicación de la expansión 1	la expansión 1 no comunica
aCM2	alarma comunicación de la expansión 2	la expansión 2 no comunica
wB0	aviso sonda B0	sonda rota o no conectada
wB2	aviso sonda B2	sonda rota o no conectada
wB4	aviso sonda B4	sonda rota o no conectada
wB5	aviso sonda B5	sonda rota o no conectada
wB6	aviso sonda B6	sonda rota o no conectada
wB8	aviso sonda B8	sonda rota o no conectada
aFP1	aviso alta presión transmisor P1	transmisor rota o no conectada
wHD	aviso alto de punto de rocío	temperatura B0>A6 por más de A8 minutos
wHT1	aviso alta temperatura de descarga	temperatura B8>A14 por más de A15 minutos
wHP1	aviso alta presión	presión P1>A16 por más de 2 segundo
wHB5	aviso alta temperature de entrada	tempertura B5>A18 por más de 1 minuto
wLP2	aviso baja presión	presión P2<A21 por más de 150 segundos
wSR	Aviso Mantenimiento programado	tiempo de servicio transcurrido
wDR1	aviso drenaje de condensados 1	drenaje de condensados de secador 1 no descarga
wDR2	aviso drenaje de condensados 2	drenaje de condensados de secador 2 no descarga
wDR3	aviso drenaje de condensados 3	drenaje de condensados de secador 3 no descarga
aFP2	aviso baja presión transmisor P2	transmisor rota o no conectada



5.5 Menú rápido

Acceda al menú mediante pasos rápidos:

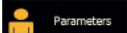
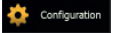
Cambiar las unidades de medida de °C a °F

- Toque 
- Toque 
- Toque 
- Toque 
- Toque el parámetro “°C” o “°F” para realizar el cambio.

Cambiar Local/rOFF

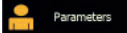
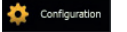
- Toque 
- Toque 
- Toque 
- Toque 
- Activar / desactivar el parámetro “ON/OFF remoto”.

Visualizar la temperatura

- Toque 
- Toque 
- Toque la temperatura para ver los gráficos.

Visualizar la presión

- Toque 
- Toque 
- Toque la presión para ver los gráficos.

Cambiar a funcionamiento “por ciclos”

- Toque 
- Toque 
- Toque 
- Toque 
- para cambiar el funcionamiento.

Cambiar el idioma

- Toque 
- Toque 

- Toque 
- para elegir el idioma.



Fecha/Tiempo

- Toque 
- Toque 
- Toque 
- para actualizar el reloj.

Descarga

- Toque 
- Toque 
- Toque 
- Toque 
- para elegir la descarga.

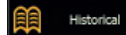
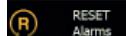

Alarma / advertencia

- Toque 
- Toque 
- para encontrar la alarma histórica y restablecer la alarma
- Toque 
- para ver los datos históricos.
- Toque 
- para restablecer la alarma.

Fecha del número de serie

- Toque 
- Toque 

Ajustar los parámetros



- Toque 
- Toque 
- Toque 
- Toque 
- para cambiar el parámetro.

Descarga

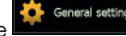
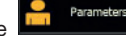

- Inserte el dispositivo USB
- Toque 

- Toque 
- para la descarga.

Cloud

- Toque 
- Toque 
- Toque 
- Toque 

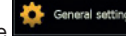
Modbus

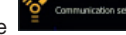
- Toque 
- Toque 
- Toque 
- Toque 

Restablecer los parámetros predeterminados

- Toque 
- Toque 
- Toque 
- Toque 
- Toque “DEF” para restablecer el parámetro.

6 Mantenimiento

- a) El aparato ha sido diseñado y fabricado para garantizar un funcionamiento continuo; No obstante, la vida útil de sus componentes depende del mantenimiento que se realice.
- b) Cuando pida ayuda o piezas sueltas, identifique el número de modelo y el número de serie de la máquina (que se encuentran en la etiqueta de serie de la unidad) y proporcione a Parker o un distribuidor Parker autorizado.
- c) Los circuitos que contengan $5t < xx < 50t$ de CO₂ deben revisarse anualmente para identificar posibles fugas. Según la normativa europea UE n.º 517/2014 art. 4.3.a, 4.3.b) - Los circuitos que contienen $50t < xx < 50t$ de CO₂ deben comprobarse cada 6 meses en busca de fugas.
- d) Según la normativa europea UE n.º 517/2014 art. 6 - Máquinas que contienen 5t CO₂ o más, el operador debe mantener un registro escrito de la cantidad y tipo de refrigerante usado, agregado o recuperado durante el mantenimiento / reparación y disposición final.

6.1 Advertencias generales

 Antes de realizar cualquier operación de mantenimiento, compruebe que:

- el circuito neumático no esté a presión,
- el secador esté desconectado de la red eléctrica.

 El uso de repuestos no originales exime al fabricante de toda responsabilidad por el mal funcionamiento del equipo.

 En caso de pérdida de refrigerante, llame a un técnico experto y autorizado.

 La válvula Schrader debe utilizarse sólo en caso de funcionamiento anómalo del equipo; de lo contrario, los daños causados por una carga incorrecta de refrigerante no serán reconocidos en garantía.

6.2 Refrigerante

 Operación de carga: los daños causados por una carga del refrigerante incorrecta realizada por personal no autorizado no serán reconocidos en garantía.

 El aparato contiene gases fluorados de efecto invernadero. El fluido refrigerante R513A, a temperatura y presión normales, es un gas incoloro perteneciente al SAFETY GROUP A1 - EN378 (fluido del grupo 2 según la directiva PED 2014/68/UE); GWP (Global Warming Potential) = 573.

 En caso de fuga de refrigerante, airee el local.

6.3 Programa de mantenimiento preventivo

Para maximizar la eficiencia, confiabilidad y longevidad de las máquinas, siga la guía de mantenimiento preventivo a continuación:



Acciones de mantenimiento	Intervalo de tiempo (condiciones de funcionamiento estándar)				
	Diarias	Semanales	4 Meses	12 Meses	36 Meses
comprobar  actuar 					
Comprobar que el indicador POWER ON está encendido.					
Comprobar todos los indicadores del panel de control.					
Limpiar el filtro de la válvula pre-sostática de agua, si no está sucio aumentar el intervalo de inspección (ver instrucciones) (PSE750-1800)					
Comprobar el purgador.					
Limpiar el condensador, rejilla y conexiones.					
Comprobar que la posición de la resistencia del cárter sea correcta					
Comprobar el consumo eléctrico.					
Comprobar las pérdidas de refrigerante.					
Despresurizar la instalación. Hacer mantenimiento integral del purgador.					
Despresurizar la instalación. Sustituir todos los elementos filtrantes de los filtros instalados.					
Comprobar las sondas de temperatura. Sustituir si fuera necesario.				 	
Conjunto de mantenimiento del secador.					

Están disponibles (apartado 8.4):

- a) kits de mantenimiento preventivo de los 3 años;
 b) kits de servicio
- compresor
 - ventilador
 - de válvula gas caliente
 - de condensador de agua
- c) piezas de repuesto individuales.

6.4 Desguace

El fluido refrigerante y el aceite lubricante contenidos en el circuito deben recogerse de conformidad con las normas locales. El líquido refrigerante se debe recuperar antes de la destrucción definitiva del equipo ((UE) N° 517/2014 art.8).

	Reciclaje Desecho 
estructura	acero/resinas epoxi-poliéster
intercambiador	aluminio
tuberías/colectores	cobre/aluminio/acero al carbono
drenaje condensados	polyamide
aislamiento intercambiador	EPS (poliestireno sinterizado)
aislamiento tuberías	caucho sintético
compresor	acero/cobre/aluminio/aceite
condensador	acero/cobre/aluminio
refrigerante	R513A
válvulas	latón
cables eléctricos	cobre/PVC

Sommaire





1 Sécurité	1
1.1 Importance de la notice	1
1.2 Signaux d'avertissement	1
1.3 Consignes de sécurité	1
1.4 Risques résiduels	1
2 Introduction	2
2.1 Transport	2
2.2 Manutention	2
2.3 Inspection ou visite	2
2.4 Stockage	2
3 Installation	2
3.1 Procédure	2
3.2 Espace de travail	2
3.3 Types de condenseurs	2
3.4 Environnement d'installation	2
3.5 Raccordement électrique	2
3.6 Raccordement purgeur des condensats	2
4 Mise en service	2
4.1 Contrôles préliminaires	2
4.2 Démarrage	2
4.3 Fonctionnement	3
4.4 Arrêt	3
5 Commande	3
5.1 Panneau de commande	3
5.2 Menu principal	4
5.2.1 État de la machine (E/S)	4
5.2.2 Pression	4
5.2.3 Température	4
5.2.4 Général	5
5.2.4.1 Langue	5
5.2.4.2 Date/Temps	5
5.2.4.3 Paramètre	5
5.2.5 Date du numéro de série	7
5.2.6 Télécharger	7
5.3 Alarmes/Avertissements	7
5.3.1 Liste des alarmes/avertissement	7
5.4 Menu Rapide	8
6 Entretien	9
6.1 Recommandations générales	9
6.2 Réfrigérant	9
6.3 Programme d'entretien préventif	9
6.4 Mise au rebut	9
7 Dépannage	10
8 Appendice	

1 Sécurité

1.1 Importance de la notice

- La notice doit être conservée pendant toute la durée de vie de la machine.
- Lire la notice avant toute opération ou intervention.
- Parker se réserve le droit d'apporter des modifications à ce manuel d'utilisation, consulter la version à bord de la machine.

1.2 Signaux d'avertissement



	Instructions pour éviter de faire courir des risques aux personnes.
	Instructions à suivre pour éviter de faire subir des dégâts à l'appareil.
	La présence d'un professionnel qualifié et agréé est exigée
	Sont présents des symboles dont la signification est donnée au paragraphe 8.

1.3 Consignes de sécurité

 Chaque unité est munie d'un sectionneur électrique pour permettre toute intervention en conditions de sécurité. Toujours actionner ce dispositif pour éliminer les risques pendant les opérations d'entretien.

 Ce manuel de l'utilisateur est destiné à aider à la fois l'utilisateur final et le technicien de maintenance. Seul un technicien formé et qualifié doit retirer les panneaux pour effectuer le service.

 Ne pas dépasser les limites définies par le projet, qui sont indiquées sur la plaque des caractéristiques.

  Il incombe à l'utilisateur d'éviter des charges différentes de la pression statique interne. En cas de risque d'activité sismique, l'unité doit être convenablement protégée.

 Tous les dispositifs de sécurité pour le circuit d'air comprimé doivent être fournis par l'utilisateur et doivent être sélectionnés selon les spécifications du système et conformément à la réglementation locale en vigueur.

N'utiliser l'unité que pour un usage professionnel et pour la destination prévue par le constructeur.

Il incombe à l'utilisateur d'analyser tous les aspects de l'application pour laquelle l'unité est installée, de suivre toutes les consignes industrielles de sécurité applicables et toutes les prescriptions inhérentes au produit contenues dans le manuel d'utilisation et dans tout autre documentation réalisée et fournie avec l'unité.

La modification ou l'adaptation ou le remplacement d'un composant quelconque par une personne non autorisée et/ou l'usage impropre de l'unité dégagent le constructeur de toute responsabilité et comportent l'annulation de la garantie.

Le constructeur ne saurait être tenu pour responsable pour tous les

dommages matériels aux choses ou à l'unité et pour tous les dommages physiques aux personnes dérivant d'une négligence des opérateurs, du non-respect de toutes les instructions de la présente notice, de l'application des normes en vigueur concernant la sécurité de l'installation. La responsabilité du constructeur est dégagée pour tous les dommages ou dégâts éventuels pouvant résulter de manipulations malveillantes et/ou de modifications de l'emballage.

L'utilisateur doit s'assurer que les conditions fournies pour la sélection de l'unité ou de ses composants et/ou options sont parfaitement conformes pour une utilisation correcte de cette même unité ou de ses composants.

 **ATTENTION: Le fabricant se réserve le droit de modifier sans aucun préavis les informations contenues dans ce manuel. Afin de disposer d'informations complètes et actualisées, il est recommandé à l'utilisateur de consulter le manuel présent à bord de l'unité.**

1.4 Risques résiduels

L'installation, la mise en marche, l'arrêt et l'entretien de la machine doivent être effectués conformément aux dispositions prévues par la documentation technique du produit et, quoiqu'il en soit, de manière à ne créer aucune situation de risque.

Les risques n'ayant pu être éliminés en phase de conception sont indiqués dans le tableau suivant.

partie concernée	risque résiduel	modalité	précautions
batterie d'échange thermique	petites coupures	contact	éviter tout contact, porter des gants de protection
grille ventilateur et ventilateur	lésions	introduction d'objets pointus à travers la grille lors du fonctionnement du ventilateur	n'introduire aucune sorte d'objets dans la grille des ventilateurs et ne poser aucun objet sur les grilles
partie interne de l'unité : compresseur et tuyau de refoulement	brûlures	contact	éviter tout contact, porter des gants de protection
partie interne de l'unité : parties métalliques et câbles électriques	intoxications, brûlures graves	incendie dû à un court-circuit ou une surchauffe de la ligne d'alimentation en amont du tableau électrique de l'unité	section des câbles et système de protection de la ligne d'alimentation électrique conformes aux normes en vigueur
partie externe de l'unité : zone environnante de l'unité	intoxications, brûlures graves	incendie dû à un court-circuit ou une surchauffe de la ligne d'alimentation en amont du tableau électrique de l'unité	section des câbles et système de protection de la ligne d'alimentation électrique conformes aux normes en vigueur

2 Introduction

Ce manuel fait référence aux sècheurs frigorifiques Parker PSE1400-6000 conçus pour éliminer la vapeur d'eau de l'air comprimé.

2.1 Transport

L'unité emballée doit rester :

- en position verticale ;
- à l'abri des intempéries ;
- à l'abri des chocs.

2.2 Manutention

Utiliser un chariot élévateur d'une capacité suffisante à soulever le poids de la machine. Éviter tous chocs pendant la manutention.

2.3 Inspection ou visite

- En usine, toutes les unités sont assemblées, câblées, chargées avec du réfrigérant et de l'huile et testées dans les conditions de travail normales ;
- Après réception de la machine, l'examiner soigneusement pour vérifier son état : recourir contre le transporteur pour les dommages éventuellement survenus au cours du transport ;
- Pour éviter toute manipulation inutile du sèche-linge, déballez l'unité le plus près possible de son lieu d'implantation.

2.4 Stockage

Si l'empilage est nécessaire, suivez les instructions indiquées sur l'emballage. Conservez l'appareil emballé dans un endroit propre et sec protégé des éléments, de la lumière directe du soleil et / ou d'autres conditions difficiles.

3 Installation

Seul le personnel compétent formé, qualifié et approuvé par Parker doit effectuer les procédures d'installation, de mise en service, de service et de réparation. Soyez prudent lorsque vous vous trouvez à proximité du sèche-linge et portez un équipement de protection approprié.

⚠ S'il est installé dans un endroit présentant un risque d'incendie, prévoir un système d'extinction d'incendie approprié. Le produit installé doit être protégé contre les risques d'incendie (réf. EN378-3).

3.1 Procédure

Installez à l'intérieur dans un endroit propre et sec qui est protégé des éléments, de la lumière directe du soleil et / ou d'autres conditions difficiles.

Respecter les indications des paragraphes 8.2 et 8.3.

Pour un fonctionnement fiable et à des fins de garantie, une préfiltration appropriée est recommandée. Sans préfiltration, le sècheur peut subir une dégradation des performances et / ou une panne permanente du sècheur. La garantie sera annulée si la qualité de l'air d'admission ne répond pas à la classe ISO8573-1 requise pour les particules et l'huile totale. Le Vendeur est exclu de toute obligation d'indemnisation ou de remboursement des dommages directs ou indirects causés par son absence.

L'élément préfiltrant doit être remplacé une fois par an ou plus, selon les recommandations du fabricant.

Raccordez correctement le sècheur aux connexions d'entrée / sortie d'air comprimé à l'aide d'un tuyau ou d'un tuyau qui répond aux exigences de température et de pression de la sortie du compresseur d'air. (voir paragraphe 8.3 et 8.6).

3.2 Espace de travail

Prévoir un espace de dégagement de 1.5 m autour de l'unité. Laisser 2 m d'espace au-dessus du sècheur pour les modèles à évacuation verticale de l'air de refroidissement.

3.3 Types de condenseurs

Version refroidie par air (Ac)

Type de condenseur standard pour tous les modèles PSE. Remarque: ne pas canaliser, créer des situations de recirculation de l'air de refroidissement ou obstruer les grilles de ventilation.

Version refroidie à l'eau (Wc)

Version refroidie par eau (Wc) - Remarque: il est recommandé d'installer un filtre à mailles sur l'entrée d'eau de refroidissement (non inclus avec le PSE en standard).

Caractéristiques de l'eau de condensation en entrée :

Température	≥50°F (10°C)	CL ⁻	<50 ppm
ΔT IN/OUT	41°-59°F 5-15°C	CaCO ₃	70-150 ppm
Max % glycole	50	O ₂	<0.1 ppm
Pression	43.5-145 PSig (3-10 barg)	Fe	<0.2 ppm
PH	7.5-9	NO ₃	<2 ppm
Conductivité électrique	10-500 μS/cm	HCO ₃ ⁻	70-300 ppm
Indice de saturation de Langelier	0-1	H ₂ S	<0.05 ppm
SO ₄ ²⁻	<50 ppm	CO ₂	<5 ppm
NH ₃	<1 ppm	Al	<0.2 ppm

Remarque: Pour les types d'eau de refroidissement spéciaux, tels que déminéralisée, désionisée ou distillée, il est nécessaire de contacter le fabricant pour vérifier si le condenseur PSE standard convient.

3.4 Environnement d'installation

Les sècheurs PSE doivent être installés uniquement à l'intérieur. Pour ne pas endommager les composants internes du sècheur et du compresseur d'air, éviter des installations où l'air des zones environnantes contient des contaminants : attention donc au soufre, à l'ammoniac, au chlore et aux installations en milieu marin.

Pour les versions avec ventilateurs axiaux, il est déconseillé de canaliser l'air épuisé.

3.5 Raccordement électrique

Utiliser un câble homologué aux sens des normes françaises en matière d'électricité et de la réglementation locale (pour la section minimale du câble, voir paragraphe 8.3).

Installer l'interrupteur magnéto-thermique différentiel en amont de l'installation (RCCB - IDn = 0.3A) avec une distance d'ouverture des contacts 0.12 in (3 mm) (voir réglementation locale en vigueur en la matière et s'y conformer).

Le courant nominal «In» de ce disjoncteur magnéto-thermique doit être égal à FLA et la courbe de déclenchement de type D.

Sélectionnez l'alimentation et insérez un pont comme indiqué ci-dessous
S7-S6 pour 400/3/50
S8-S6 pour 460/3/60
 À l'intérieur du panneau électrique, il y a une étiquette d'instructions.

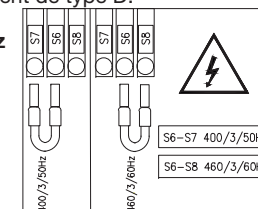

3.6 Raccordement purgeur des condensats

Réaliser le raccordement au système de décharge en évitant le raccordement en circuit fermé en commun avec les autres circuits de décharge pressurisés. Contrôler que les systèmes de décharge évacuent régulièrement les condensats. Évacuer tous les condensats conformément à la législation antipollution en vigueur.

4 Mise en service

4.1 Contrôles préliminaires

Avant la mise en service du dessiccateur, vérifiez que :

- Toutes les informations de la section 3 ont été lues, comprises et exécutées correctement ;
- la soupape d'admission d'air est ouverte et aucun écoulement d'air n'est présent dans le dessiccateur ;
- l'alimentation fournie est correcte ;
- Remarque: Si vous utilisez une version Wc, ouvrez le circuit d'eau de refroidissement 5 minutes avant de démarrer le sèche-linge.

4.2 Démarrage

a) Mettre sous tension en tournant l'interrupteur général «  » sur

« I ON » :

⚠ LA RESISTANCE CARTER DOIT ETRE BRANCHEE 12 HEURES

AVANT LA MISE EN MARCHÉ DU SECHEUR.

	EN - THE CRANKCASE HEATER MUST BE SWITCHED ON 12 HOURS BEFORE STARTING THE DRYER.
	IT - LA RESISTENZA CARTER DEVE ESSERE INSERITA 12 ORE PRIMA DI AVVIARE L'ESSICCATORE.
	FR - LA RESISTANCE CARTER DOIT ETRE BRANCHEE 12 HEURES AVANT LA MISE EN MARCHÉ DU SECHEUR.
	DE - DIE VERSORGUNG DER KURBELWANNENHEIZUNG IST 12 STUNDEN VOR DER EINSCHALTUNG DES TROCKNERS FREIZUGEBEN.

Appuyer pour revenir le panneau de commande

b) Appuyer sur pour démarrer. Le bouton change de couleur, de gris il devient vert, pour indiquer que le dessiccateur est maintenant en marche .

Le non-respect de cette instruction peut endommager gravement le compresseur.

c) Démarrer le dessiccateur avant le compresseur d'air.

Ventilateurs (version Ac) : s'ils sont raccordés dans l'ordre de phases incorrect, ils tourneront dans la direction opposée, avec le risque qu'ils subissent des dégâts (dans ce cas, l'air sort de l'armoire du dessiccateur par les grilles du condenseur plutôt que par les grilles des ventilateurs - pour le débit d'air correct, voir les par. 8.6 et 8.7) ; inverser immédiatement deux phases.

d) Attendez 5 minutes, puis ouvrez lentement et partiellement la soupape d'admission. Laissez le sécheur atteindre la pression de la ligne avant d'ouvrir complètement la vanne d'entrée.

e) Une fois que le sécheur est à la pression de la ligne et que la vanne d'entrée est complètement ouverte, ouvrez lentement la vanne de sortie d'air; le sèche-linge sèche maintenant

Moniteur des phases

Si l'alarme « Moniteur des phases » s'affiche pendant le démarrage du dessiccateur, l'utilisateur doit vérifier le câblage des bornes d'entrée du sectionneur du dessiccateur.

4.3 Fonctionnement

- Laissez toujours le dessiccateur allumé lorsque le compresseur est en marche et fonctionne.
- Le dessiccateur travaillant en automatique, il n'est donc pas nécessaire d'ajuster constamment les réglages sur le terrain. Voir la section 5 pour la navigation dans les commandes.
- En cas d'excès d'air imprévu ou de pics de charge d'humidité, contourner le dessiccateur pour éviter de le surcharger.
- Éviter les variations de température d'entrée.

4.4 Arrêt

Arrêtez le compresseur ou le flux d'air à travers le sécheur et attendez 2 minutes avant d'arrêter le dessiccateur; Fermez la vanne d'air d'admission pour vous assurer que l'air comprimé ne pénètre pas dans le dessiccateur lorsqu'il est déconnecté ou en cas d'alarme.

e) Appuyer sur pour mettre le dessiccateur hors tension.

Le bouton change de couleur et devient gris.

f) Tourner l'interrupteur général « » sur « O OFF » pour mettre hors tension.

En version Wc, fermer le circuit d'eau avec le dessiccateur arrêté.

5 Commande

5.1 Panneau de commande

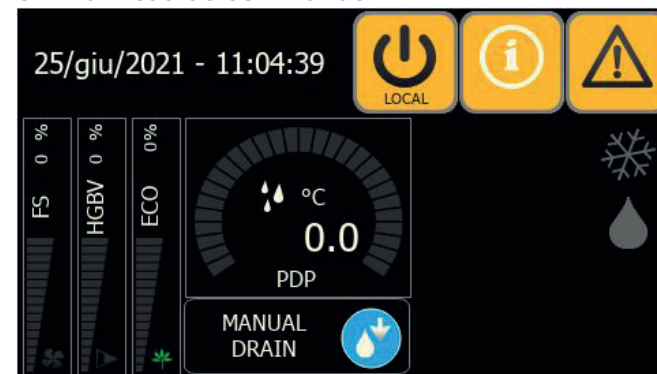

Boutons	Fonction	
	Bouton ON/OFF	OFF (gris)
		ON (vert)
local	à distance	
	Accès au menu Information : état de la machine, pressions, températures, paramètres généraux, consommation, mot de passe utilisateur	
	Accès au menu Alarme : alarmes/avertissements et historique des alarmes.	
	Dryer OFF = gris clair Cycling active = vert clignotant Compressor active = bleu clair	

Autres informations

	Vitesse de fonctionnement du ventilateur (uniquement pour la version à condenseur à air)		Vitesse de fonctionnement de la soupape des gaz chauds		économie d'énergie.% (Cycle)
--	--	--	--	--	------------------------------

	Tendance du point de rosée		Affiche l'état ON/OFF du purgeur
			Appuyer: pour une purge manuelle

5.2 Menu principal

Appuyer sur  pour ouvrir le menu Information :

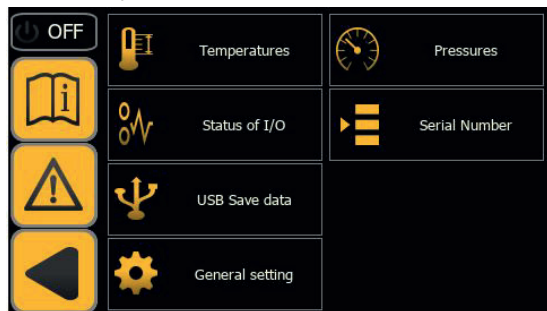

Quand un des boutons est enfoncé pendant quelques secondes, le contour s'allume pour confirmer que la sélection a été effectuée.

Ceci vaut pour tous les boutons du panneau de commande.

Appuyer sur  pour revenir les panneau de commande

5.2.1 État de la machine (E/S)

Appuyer sur  pour ouvrir le menu État de la machine.
Liste des entrées :

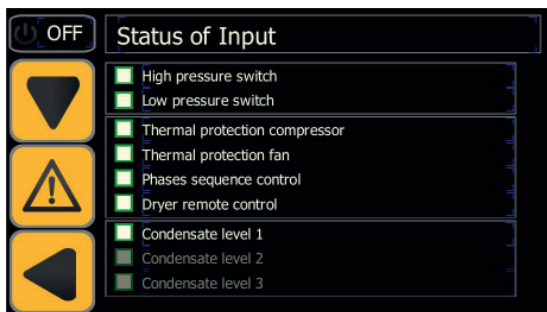

Une LED à côté de la description indique si les protections / fonctions / configurations sont :
actives = vert clair
pas actives = gris clair

Appuyer sur  pour passer à la page suivante.

Liste des sorties :

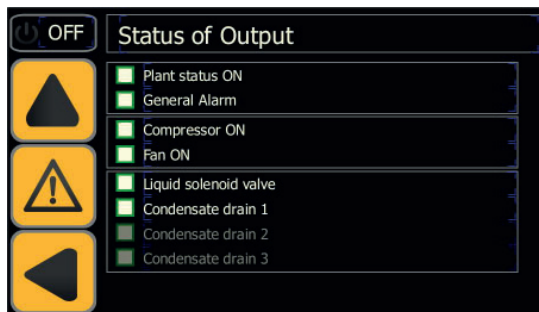

Appuyer sur  pour revenir au menu précédent.

5.2.2 Pression

Appuyer sur  pour ouvrir le menu Pression pour visualiser : la pression de condensation, la vitesse de fonctionnement du ventilateur, la pression d'évaporation, la vitesse de fonctionnement de la soupape des gaz chauds.

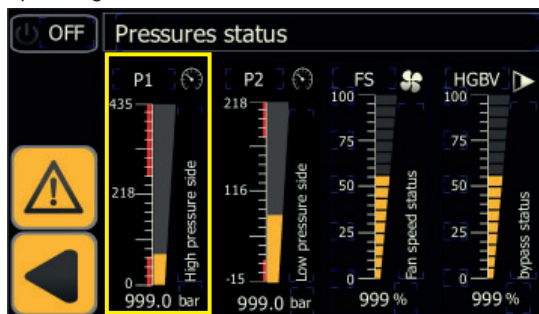

Appuyez sur un paramètre spécifique pour afficher la tendance des données de ses performances au fil du temps. p.ex. Pression de condensation/d'évaporation

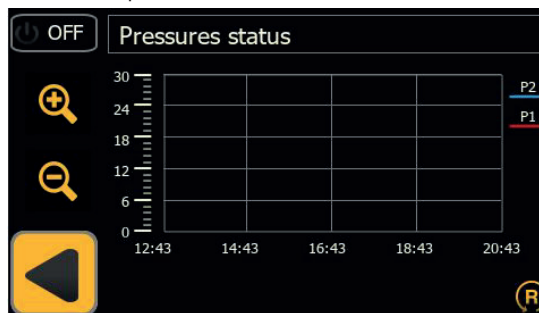

Utiliser  et  pour faire défiler le graphique.

p.ex. Vitesse de fonctionnement de la soupape des gaz chauds/du ven-

tilateur

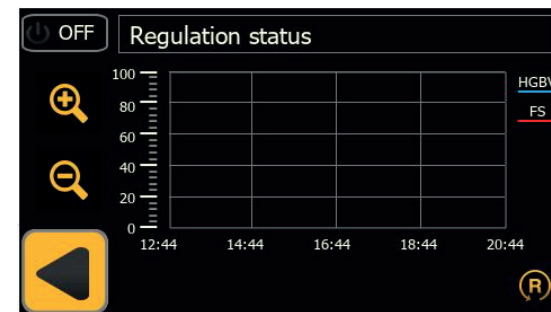

Utiliser  et  pour faire défiler le graphique.

Appuyer sur  pour revenir au menu précédent.

Appuyer sur  pour revenir les panneau de commande

5.2.3 Température

Appuyer sur  pour afficher les températures relevées par les capteurs de température du schéma du circuit.

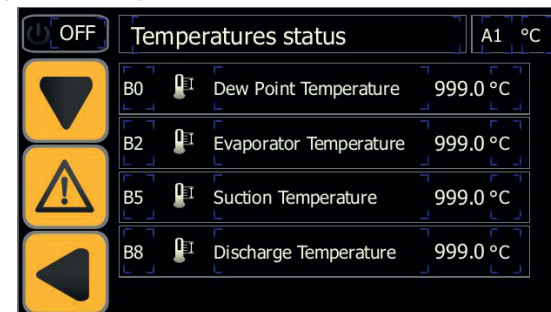

Appuyer sur  pour passer à la page suivante.

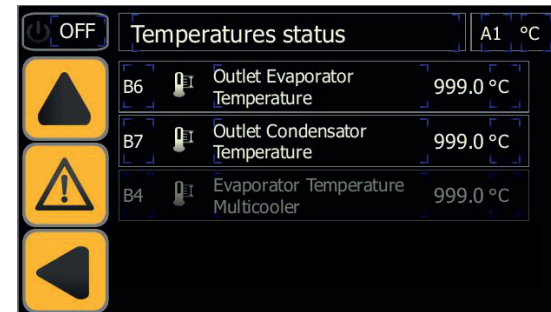

B4 = actif uniquement pour la version multicooler.

Appuyez sur l'une des valeurs de température basse pression pour voir

une tendance des données de toutes les sondes du circuit basse pression.

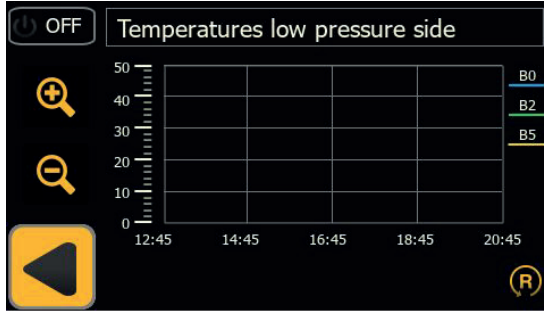

Utiliser et pour faire défiler le graphique.

Appuyez sur l'une des valeurs de température haute pression pour voir une tendance des données de toutes les sondes du circuit haute pression.

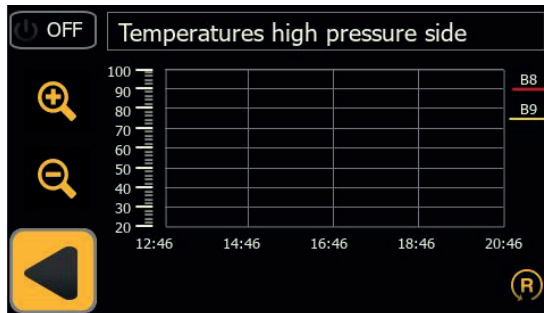

Utiliser et pour faire défiler le graphique.

Appuyer sur pour revenir au menu précédent.

5.2.4 Général

Appuyer sur pour ouvrir le menu Général qui propose les sections suivantes : langue ; date/heure ; paramètre ; maintenance ; cycle/fonctionnement continu.

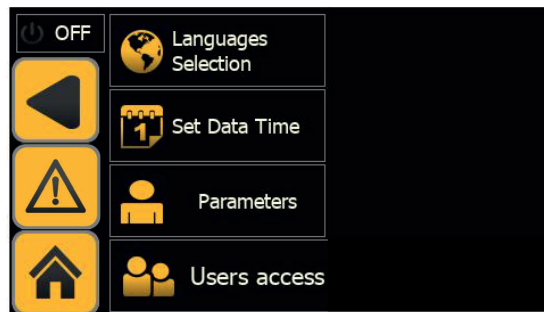

Appuyer un menu pour afficher / régler.

Appuyer sur pour revenir les panneau de commande

5.2.4.1 Langue

Appuyer sur pour ouvrir le menu Langue.



Appuyer sur la langue souhaitée.

Le système revient automatiquement au menu principal dans la langue choisie.

5.2.4.2 Date/Temps

Appuyer sur pour ouvrir le menu Date/temps.

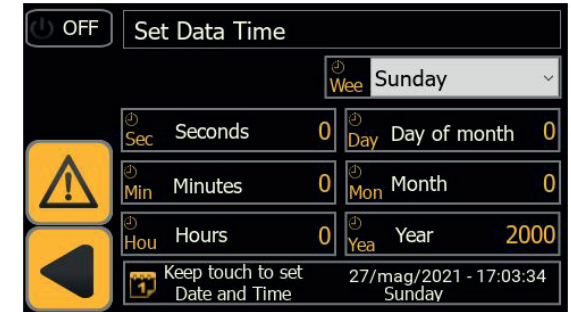

Appuyer sur Date/Temps pour effectuer la modification.

Appuyez pendant 2 secondes pour confirmer.

Appuyer sur pour revenir au menu précédent.

Appuyer sur pour revenir à l'écran d'accueil.

5.2.4.3 Paramètre

Appuyer sur pour ouvrir le menu Paramètre qui propose les sections suivantes : capteurs, purgeur, configuration de l'eau de condensation, maintenance, cycle.

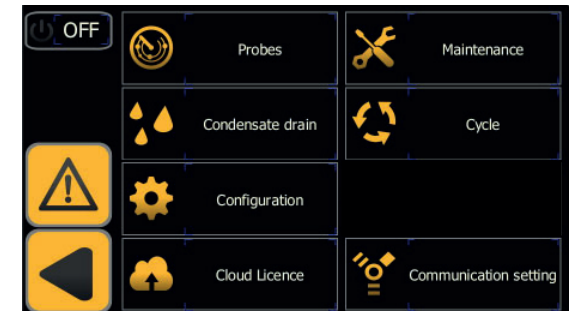

Appuyer sur le bouton pour ouvrir le menu.

Appuyer sur pour revenir les panneau de commande

Capteurs

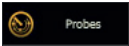
Appuyer sur  pour paramétrer les avertissements et les retards ou le point de rosée minimum/maximum.



Purgeur de l'eau de condensation

Appuyer sur  pour ouvrir le menu Purgeur de l'eau de condensation.



pour fixer:
 Purgeur temporisé (avec choix des heures de fermeture et d'ouverture) ;
 Purgeur capacitif ;
 Purgeur continu (purgeur externe).

Appuyer sur  pour revenir au menu précédent.

Configuration

Appuyer sur  pour ouvrir l'écran de configuration avec le menu suivant :
 Choix de l'affichage de température en °C / °F ;
 Activation du démarrage à distance ;
 Activation des alarmes uniquement ou des alarmes / avertissements ;
 Rétablissement des paramètres par défaut.

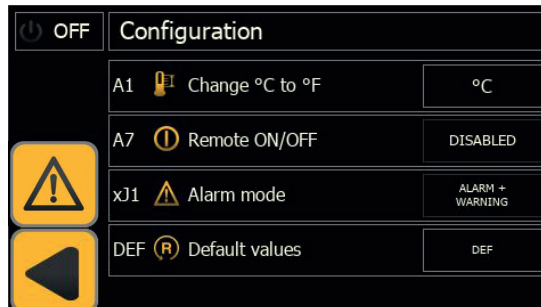



Utiliser le bouton pour fermer la description et faire son choix.

Appuyer sur  pour revenir au menu précédent.

Maintenance

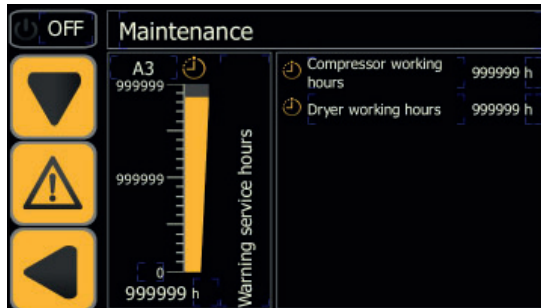
Appuyer sur  pour afficher les heures de fonctionnement du compresseur/dessiccateur.



Appuyer sur  pour revenir au menu précédent.

Fonctionnement

Appuyer sur  pour choisir le type de fonctionnement : continu ; cycle (économie d'énergie).





Touchez le paramètre pour effectuer le réglage

Appuyer sur  pour revenir au menu précédent.

Cloud

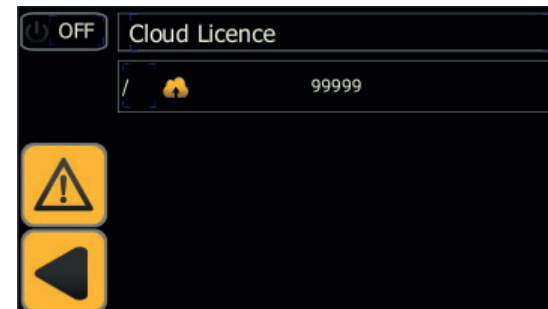
Appuyer sur  pour voir « password » pour le cloud .



Appuyer sur  pour revenir au menu précédent.

Modbus

Appuyer sur  pour régler les paramètres Modbus.

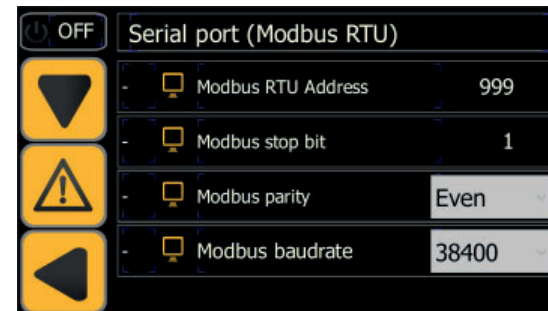

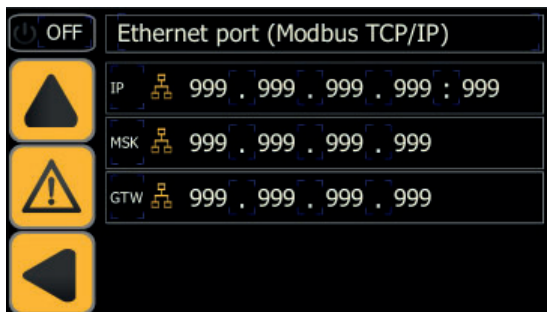

Appuyer sur pour revenir au menu précédent.

5.2.5 Date du numéro de série

Appuyer sur pour ouvrir le menu «serial number».

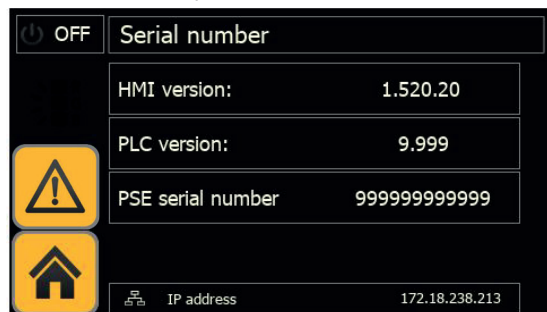

Appuyer sur pour revenir les panneau de commande.

5.2.6 Télécharger

Appuyer sur pour télécharger les graphiques des températures et des pressions. Utilisez une clé USB avec led, qui vous montre la phase de téléchargement.

Appuyer sur pour revenir les panneau de commande.

5.3 Alarmes/Avertissements

Appuyer sur pour ouvrir le menu Alarmes/Avertissements.



Touchez « duration » pour modifier l'heure de la recherche.

Appuyer sur pour revenir au menu précédent.

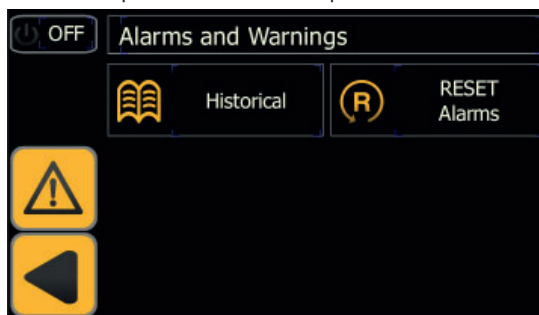

Après le rétablissement des conditions de fonctionnement nominales, certains avertissements et certaines alarmes sont réinitialisés automatiquement. D'autres doivent être réinitialisés manuellement.

Appuyer sur pour réinitialiser l'alarme.

Appuyer sur pour afficher l'historique des alarmes avec les informations suivantes : code alarme, date, nombre d'alarmes, position dans l'ordre d'occurrence et date/heure d'activation des alarmes.

Appuyer sur pour revenir les panneau de commande

5.3.1 Liste des alarmes/avertissement



a = alarme
w = avertissement

aLD	alarme Bas point de rosée	température B0<A9 pour plus de A10 seconds.
aLT	alarme basse température d'évaporation.	température B2<A12 pour plus de A13 seconds
aHT2	alarme de température de refoulement élevée	température B8>A11
aHP	alarme haute pression	pressostat haute pression activé
aLP	alarme basse pression	pressostat basse pression activé
aLTA	alarme basse température multicoocter	température B4<A12 pour plus de A13 seconds
aPI	alarme Protection thermique compresseur.	protection thermique compresseur activé
aPH	alarme moniteur de phase	moniteur de phase activé
aCM1	alarme communication expansion 1	l'expansion 1 ne communique pas
aCM2	alarme communication expansion 2	l'expansion 2 ne communique pas
wB0	avertissement sonde B0	sonde cassée ou non connectée
wB2	avertissement sonde B2	sonde cassée ou non connectée
wB4	avertissement sonde B4	sonde cassée ou non connectée
wB5	avertissement sonde B5	sonde cassée ou non connectée
wB6	avertissement sonde B6	sonde cassée ou non connectée
wB8	avertissement sonde B8	sonde cassée ou non connectée
aFP1	alarme haute pression transmetteur P1	transmetteur cassée ou non connectée
wHD	avertissement haute point de rosée	température B0>A6 pour plus de A8 minutes
wHT1	avertissement de température de refoulement élevée	température B8>A14 pour plus de A15 minutes
wHP1	avertissement haute pression	pression P1>A16 pour plus de 2 seconds
wHB5	avertissement de température d'aspiration élevée	température B5>A18 pour plus de 1 minute
wLP2	avertissement basse pression	pression P2<A21 pour plus de 150 seconds
wSR	avertissement Entretien programmé	le temps de service défini a expiré
wDR1	avertissement purgeur de condensats 1	le condensat ne s'écoule pas du sécheur 1
wDR2	avertissement purgeur de condensats 2	le condensat ne s'écoule pas du sécheur 2
wDR3	avertissement purgeur de condensats 3	le condensat ne s'écoule pas du sécheur 3
aFP2	alarme basse pression transmetteur P2	transmetteur cassée ou non connectée



5.4 Menu Rapide

Ouvrir le menu en quelques étapes :

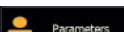
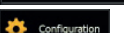
Modifier l'unité de mesure °C en °F

- Appuyer sur 
- Appuyer sur 
- Appuyer sur 
- Appuyer sur 
- Appuyer sur le paramètre °C ou °F pour effectuer la modification

Modifier Local/rOFF

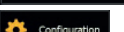
- Appuyer sur 
- Appuyer sur 
- Appuyer sur 
- Appuyer sur 
- Activer/désactiver le paramètre Démarrage à distance ON/OFF.

Afficher la température

- Appuyer sur 
- Appuyer sur 
- Appuyer sur la température pour afficher les graphiques.

Afficher la pression

- Appuyer sur 
- Appuyer sur 
- Appuyer sur la pression pour afficher les graphiques.

Passer en mode Cycle

- Appuyer sur 
- Appuyer sur 
- Appuyer sur 
- Appuyer sur 
- Modifier le mode de fonctionnement

Modifier la langue

- Appuyer sur 
- Appuyer sur 

- Appuyer sur 
- Choisir la langue



Date/Temp

- Appuyer sur 
- Appuyer sur 
- Appuyer sur 
- Mettre à jour l'horloge

Purgeur

- Appuyer sur 
- Appuyer sur 
- Appuyer sur 
- Appuyer sur 
- Choisir le purgeur

Alarme / Avertissement

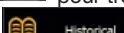
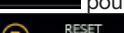
- Appuyer sur 
- Touch  pour trouver l'alarme historique et réinitialiser l'alarme
- Touch  pour afficher l'historique
- Appuyer sur  pour réinitialiser l'alarme.

Date du numéro de série

- Appuyer sur 
- Appuyer sur 

Réglage du paramètre





- Appuyer sur 
- Appuyer sur 
- Appuyer sur 
- Appuyer sur 
- Modifier le paramètre

Télécharger

- Insérer la clé USB
- Appuyer sur 

- Appuyer sur  pour télécharger.

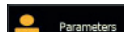
Rétablir les paramètres par défaut

- Appuyer sur 
- Appuyer sur 
- Appuyer sur 
- Appuyer sur 
- Appuyer sur DEF pour rétablir le paramètre.

6 Entretien

- a) La machine est conçue et fabriquée pour garantir un fonctionnement continu ; toutefois, la durée de vie de ses composants est directement liée à l'entretien effectué.
- b) Pour toute demande d'assistance ou de pièces détachées, identifier le numéro de modèle et le numéro de série de la machine (situés sur l'étiquette de série de l'unité) et les fournir à Parker ou à un distributeur Parker agréé.
- c) Les circuits contenant 5t < xx < 50t ou CO₂ doit être vérifié annuellement pour identifier toute fuite potentielle. Conformément au règlement européen UE n° 517/2014 art. 4.3.a, 4.3.b) - Les circuits contenant 50t < xx < 50t de CO₂ doivent être vérifiés pour les fuites tous les 6 mois.
- d) Conformément au règlement européen UE n° 517/2014 art. 6 - Machines contenant 5t de CO₂ ou plus, l'exploitant doit conserver un enregistrement écrit de la quantité et du type de fluide frigorigène utilisé, ajouté ou récupéré lors de la maintenance / réparation et de l'élimination finale.

6.1 Recommandations générales

-  Avant toute opération d'entretien, s'assurer que :
- le circuit d'air comprimé n'est plus sous pression ;
 - que le sècheur soit débranché du réseau d'alimentation électrique.

 Utiliser toujours des pièces de rechange d'origine ; dans le cas contraire, le constructeur est dégagé de toute responsabilité pour le mauvais fonctionnement de la machine.

 En cas de fuite du réfrigérant, appeler un professionnel qualifié et agréé par le constructeur.

 La vanne ou valve Schrader ne doit être utilisée qu'en cas d'anomalie de fonctionnement de la machine : dans le cas contraire, les dommages causés par une charge de réfrigérant incorrecte ne seront pas reconnus au titre de la garantie.

6.2 Réfrigérant















 Opération de charge : les dommages éventuels causés par une charge incorrecte de réfrigérant effectuée par un personnel non habilité ne seront pas reconnus au titre de la garantie.

 L'appareil contient des gaz à effet de serre fluorés. Le fluide frigorigène R513A à température et pression normales est un gaz incolore appartenant au SAFETY GROUP A1 - EN378 (fluide groupe 2 selon la directive PED 97/23/EC); GWP (Global Warming Potential) = 573.

 En cas de fuite de réfrigérant, aérer le local.

6.3 Programme d'entretien préventif

Pour maximiser l'efficacité, la fiabilité et la longévité des machines, suivez le guide d'entretien préventif ci-dessous:

Description opération d'entretien	Périodicité d'entretien recommandée (conditions de fonctionnement standard)				
	Tous les jours	Toutes les semaines	Tous les 4 mois	Tous les 12 mois	Tous les 36 mois
Opération contrôler  service 					
Contrôler que le témoin POWER ON est allumé					
Contrôler les indicateurs du tableau des commandes.					
Nettoyer le filtre de la vanne pressostatique à eau s'il n'est pas sale augmenter l'intervalle de contrôle (voir notice) (PSE750-1800)					
Contrôler le purgeur des condensats.					
Nettoyer les ailettes du condenseur					
Contrôler le positionnement correct de la résistance carter.					
Contrôler la consommation électrique.					
Contrôler les fuites de réfrigérant.					
Dépressurisation de l'installation. Effectuer l'entretien du purgeur.					
Dépressurisation de l'installation. Remplacer les éléments du préfiltre et du post-filtre.					
Contrôler les sondes de température. Remplacer si nécessaire.				 	
Kit d'entretien séchoir.					



Sont disponibles (voir paragraphe 8.4) :

- a) Kits d'entretien préventif 3 ans ;
b) Kits d'entretien

- compresseur ;
 - ventilateur ;
 - soupape à gaz chaud ;
 - condenseur d'eau ;
- c) pièces détachées.

6.4 Mise au rebut

Le fluide frigorigène et le lubrifiant (huile) contenus dans le circuit devront être récupérés selon la législation antipollution. La récupération du fluide réfrigérant est effectuée avant la destruction définitive de l'équipement ((UE) N° 517/2014 art.8).

	Recyclage Élimination 
charpenterie (ossature)	acier/résines époxy-polyester
échangeur	aluminium
tuyauteries/collecteurs	cuivre/aluminium/acier au carbone
purgeur	polyamide
isolation échangeur	EPS (polystyrène fritté)
isolation tuyauteries	caoutchouc synthétique
compresseur	acier/cuivre/aluminium/huile
condenseur	cuivre/aluminium
réfrigérant	R513A
valves ou vannes	laiton
câbles électriques	cuivre/PVC



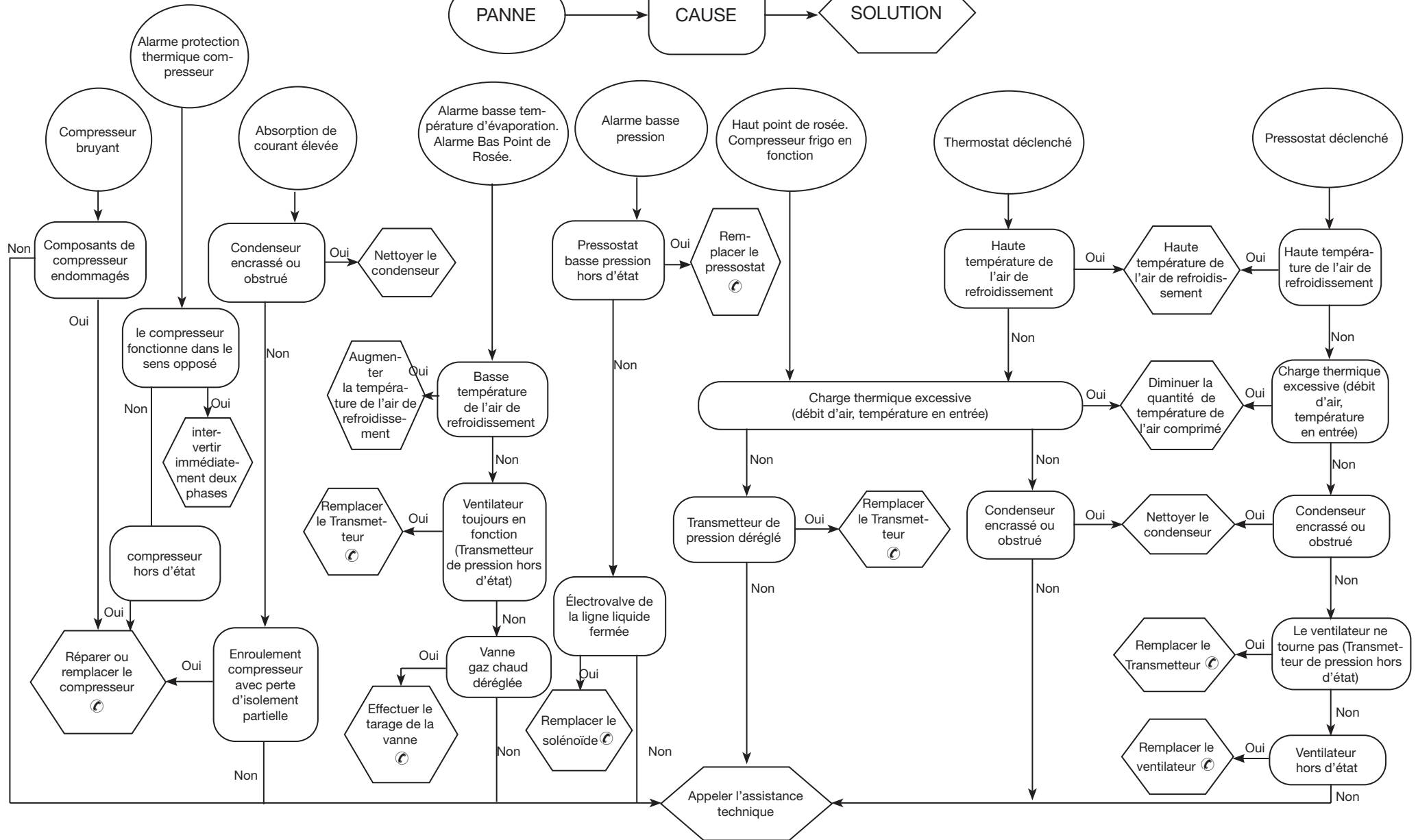

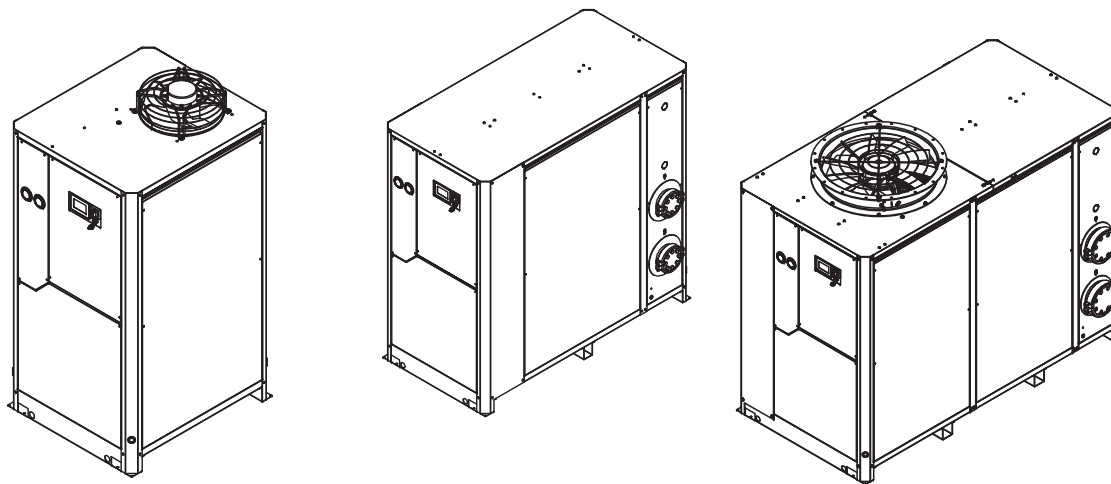









7 Dépannage





























CONTENTS

8.1 LEGEND	2
8.2 INSTALLATION DIAGRAM	4
8.3 TECHNICAL DATA	5
8.4 SPARE PARTS	6
8.5 EXPLODED DRAWING	8
8.6 DIMENSIONAL DRAWING	17
8.7 REFRIGERANT CIRCUIT	24
8.8 WIRING DIAGRAM PSE 1400-2000	30
WIRING DIAGRAM PSE 2400-6000	41

Symbol	/EN/ES/FR
	Weight / Peso/ Poids /
	/ Ambient temperature / Temperatura ambiente / Température Ambiente
	/ During transport and stockage / Durante transporte y almacenaje / Pendant le transport et le stockage
	/ After installation / Después de la instalación / Après l'installation
	/ Air-side max. working pressure / Presión máxima de trabajo lado aire / Pression maximum d'utilisation côté air
	/ Compressed air inlet temperature / Temperatura entrada aire comprimido / Température entrée air comprimé
	/ Minimum cable size for electrical connection. / Sección mínima cable homologado para conexionado Eléctrico / Section minimale câble homologué pour le raccordement électrique.
	/ Compressed air inlet / Entrada aire comprimido / Entrée air comprimé
	/ Compressed air outlet / Salida aire comprimido / Sortie air comprimé
	/ Cooling water inlet / Entrada agua de enfriamiento / Entrée eau de refroidissement
	/ Cooling water outlet / Salida agua de enfriamiento / Sortie eau de refroidissement
	/ Calibration values / Valores de calibración / Valeurs de réglage
	/ Electrical supply inlet / Entrada alimentación eléctrica / Entrée alimentation électrique
	/ Condensate drain / Drenaje de condensados / Purge des condensats
	/ Limit of equipment / Límite del equipo / Limite de l'appareil

Symbol	/EN/ES/FR
	/ Sound pressure level (1m distance in free field - according to ISO 3746). / Nivel de presión sonora (a 1 m de distancia en campo libre, según norma ISO 3746) / Niveau de pression sonore à 1 mètre de distance en champ libre (selon norme ISO 3746)
	/ Cooling air outlet / Salida aire de enfriamiento / Sortie air de refroidissement
	/ Cooling air inlet / Entrada aire de enfriamiento / Entrée air de refroidissement
	/ General alarm / Alarma general / Alarme générale
	/ Optional / Opcional / Option
	/ Compressor / Compresor / Compresseur
	/ Refrigerant condenser / Condensador refrigerante / Condenseur réfrigérant
	/ Sewp heat exchanger
	/ Fan motor / Electroventilador / Électroventilateur
	/ Refrigerant filter / Filtro refrigerante / Filtre réfrigérant
	/ Liquid line solenoid valve / Electroválvula línea de líquido / Électrovanne ligne de liquide
	/ Expansion capillary / Capillar expansión / Tubo de détente
	/ Evaporator / Evaporador / Évaporateur
	/ Low pressure transmitter
	/ Pressure point / Toma de presión / Prise de pression
	/ Pressure gauge
	/ Low pressure switch / Presostato baja presión / Pressostat basse pression
	/ Electronic hot gas valve / Válvula gas caliente / Vanne gas valve
	/ High pressure swith / Presostato alta presión / Pressostat haute pression
	/ High pressure transmitter
	/ Condensate drain valve / Grifo drenaje condensados / Robinet décharge condensats

Symbol	/EN/ES/FR
	/ Condensate filter valve / Filtro drenaje condensados / Filtre décharge condensats
	/ Condensate drain solenoid valve / Electroválvula drenaje condensados / Électrovanne décharge condensats / Škidruma separators
	/ Water pressostatic valve / Válvula presostática agua / Valve presostatique eau
WPV	
-	/ Panels / Paneles / Panneaux
A1	/ Control Card / Tarjeta electrónica / Carte électronique
A2	/ Serial card / Tarjeta serie / Carte série
AI	/ Analog Inputs / Entradas analógicas / Entrées analogiques
B0	/ Dew point temperature sensor / Sensor temperatura punto rocío / Capteur de température dew point
B2	/ Evaporation temperature sensor / Sensor temperatura evaporación / Capteur de température évaporation
B3	/ Ambient temperature sensor
B5	/ Suction temperature sensor
B8	/ Discharge temperature sensor / Sensor temperatura salida refrigerante / Capteur de température départ réfrigérant
Cs	/ Condensate level sensor / Sensor de nivel / Capteur de niveau
EH1	/ Crankcase heater / Resistencia cárter / Résistance carter
FA1	/ Control card fuse / Fusible tarjeta electrónica / Fusible carte électronique
FU1-4 FU11	/ Fuses / Fusibles / Fusibles
DI	/ Digital Inputs / Entradas digitales / Entrées numériques
KA1	/ High pressure alarm relay / Relé alarma presostato alta presión / Relais alarme pressostat haute pression
KM1	/ Compressor contactor / Contactor compresor / Contacteur compresseur
KM2	/ Fan contactor / Contactor ventilador / Contacteur ventilateur
QF1	/ automatic switch / Interruptor automático / Interrup. automatique
QS1	/ Main power switch / Interruptor general / Interrupteur général
RO	/ Remote Off / Apagado remoto / Def remoto

Symbol	/EN/ES/FR
SL	/ Serial line / Línea serie / Liaison série
TC1	/ Auxiliary transformer / Transformador auxiliares / Transformateur auxiliaires
DO	/ Digital Outputs / Salidas digitales / Sorties numériques
X1-X5	/ Terminal blocks / Borneras / Boîtes à bornes
(#)	<p>Components for models with TIMED drain. For other external drains, consult the constructor's manual.</p> <p>Componentes presentes en el modelo con sistema de drenaje TEMPORIZADO. Para los dispositivos de drenaje externos, consulte el manual de fábrica respectivo.</p> <p>Composants présents dans les modèles avec purgeur temporisé. Pour d'autres purgeurs externes, consulter la notice spécifique du constructeur.</p>

1	2	3	4
Air compressor Compresor de aire Compresseur d'air	Dryer Secador Sécheur	By-pass unit Grupo by-pass Groupe by-pass	Filter (3 micron filtration or better) near dryer air inlet Filtro (filtración de 3 micrones o mejor) cerca de la entrada de aire de la secadora Filtre (filtration des particules de 3 microns minimum) à proximité de l'orifice d'admission d'air du sécheur

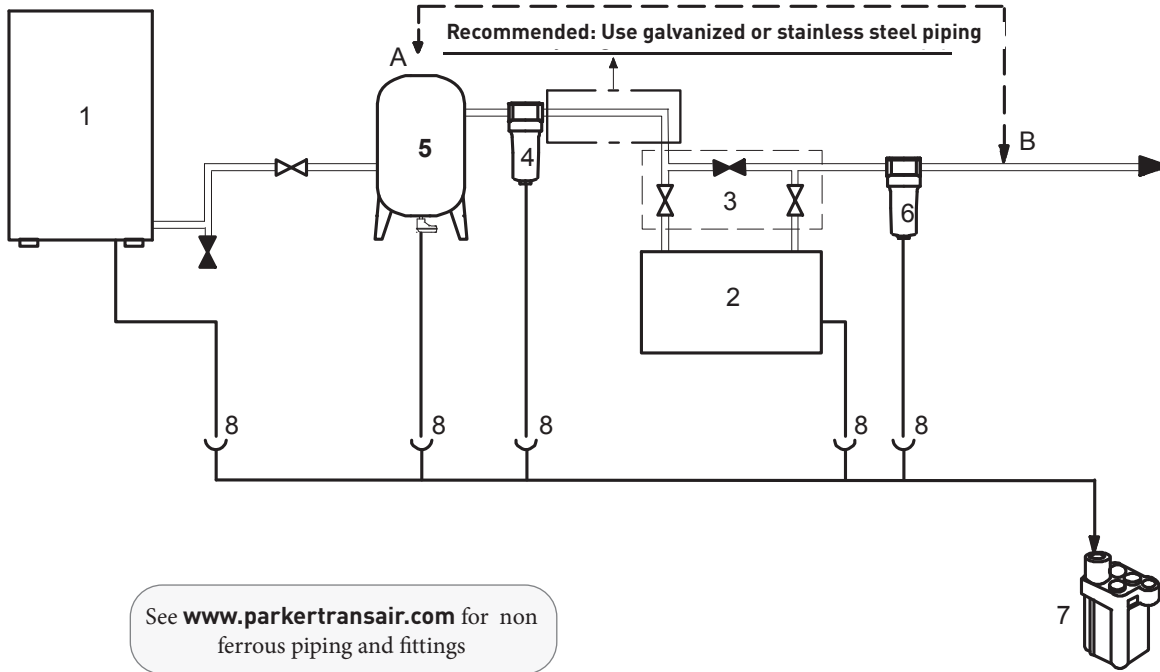









See www.parkertransair.com for non ferrous piping and fittings



Safety relief valves should not exceed dryer design pressure
Válvulas de seguridad para no superar la presión de diseño del secador
Soupapes de sécurité, pour ne pas dépasser la pression préétablie du sécheur

Use flexible hoses for air connections if the compressed air system is subject to vibration.
Tubos flexibles para las conexiones de aire si la red está expuesta a vibraciones
Tuyaux flexibles pour raccords de l'air si le réseau est soumis à des vibrations

5	6	7	8
Tank in position A or in B Depósito en la posición A o B Réservoir en position A ou B	Outlet filter Filtro de salida Filtre en sortie	Oil-Water separator Separador agua-aceite Séparateur eau-huile	Condensate drain Drenaje de condensados Purgeur des condensats

Use pulsation dampers if compressed air system is subject to pulsation
Amortiguadores si la red está expuesta a pulsaciones
Amortisseurs hydrauliques appropriés si le réseau est soumis à des pulsations

Model	Weight 	Refrigerant R513A				N° of coolers	MIN.- MAX Ambient Temperature 		Compressed air inlet Temperature 	F.L.A.[A] 460V±10% /3Ph/60Hz	MOP	MCA	Minimum cable size for electrical connection	Connections			Sound pressure level 
		Ac		Wc			During transport and stockage 	After installation 						Compres. air IN/OUT 	Cooling Water IN/OUT 	Conden. drain 	
	Kg	Kg	CO ₂ e(t)	Kg P. T./S&T	CO ₂ e(t) P.T./S&T	N°			A	A	A	Ø [mm2]	-	NPT-F	NPT-F	[dB (A)]	
PSE 1400	380	2.6	1.49	2.0/-	1.1/-	1	32-122°F (0-50°C)	41-122°F (5-50°C)	41-149°F (5-65°C)	14.2	30	17.5	4G10AWG	4" FLG ANSI 150	1"	69	
PSE 1600	420	2.8	1.6	2.5/-	1.43/-	1				20.5	40	25.5					
PSE 2000	730	7.6	4.35	2.4/3.2	1.37/1.83	2				31.6	65	39	4G8AWG	6" FLG ANSI 150	1.1/4"		
PSE 2400	770	7.0	4.01	7.5/8.5	4.3/4.87	2				37.8	80	47					
PSE 3000	-	-	-	-/-	-/-	2				37.8	80	47					
PSE 3800	850	6.0	3.44	5.5/6.0	3.15/3.44	2				37.8	80	47	4G4AWG				
PSE 5000	1070	15	8.61	12.0/-	6.88/-	3				52.3	110	65	8" FLG ANSI 150				
PSE 6000	1210	13.0	7.45	8.4/-	4.82/-	3				59.4	125	74					

Calibration values 	Hot gas valve 12 - HGV	Pressure condensation		High pressure Switch 13-HP	Low pressure Switch 10-LP	Operating Pressure Max 	Water pressostatic valve 3-WPV	IP	Safety valve
		Pressure	Fan speed						
PSE 1400-5000	35-38 psi 2.4-2.6 bar	145-188psi 10-13 bar	0 % 100 %	290psi 20 bar	14.5-29psi 1.0-2.0 bar	203psi 14 bar	232psi 16 bar	54	-
PSE 6000									320psi 22 bar

P.T. = Plate type exchanger; S&T= Shell and tube exchanger

COMPONENTS		See par. 8.5	PSE 1400	PSE 1600	PSE 2000	PSE 2400	PSE3000	PSE 3800	PSE 5000	PSE 6000
3 years preventive maintenance kits	Ac	⑥ ⑫ ⑮ B1 B2 B3 KM2	398H473757							
	Wc	⑥ ⑮ B1 B2 B3								
Electrical Kit	Ac/Wc		398H473759							
Compressor kit	Ac/Wc	① ⑧ KM1	398H473766	398H473768	398H473769	398H473770			398H473771	398H473772
Fan kit	Ac	③ KM2	398H473774			398H473775			398H473776	
Hot gas valve kit	Ac/Wc	④ ⑫	398H473779	398H473780	398H473781			398H473782		
Refrigerant condenser	Ac	②	ET-398H114845			ET-398H114846			ET-398H114847	
Plate type exchanger	Wc	②.1	on request			on request	on request			on request
Shell & tube exchanger	Wc	②.2	ET-398H186234	ET-398H186235	ET-398H186236	ET-398H186237			ET-398H186193	
Water pressostatic valve	Wc	③.	ET-398H378209			ET-398H378204			Et-398H378220	
Refrigerant filter	Ac/Wc	④	398H206223	398H206224						
Liquid line solenoid valve	Ac/Wc	⑤	ET-398H183148							
Water - air exchanger / Separator / Air-air exchanger	Ac/Wc	⑦	on request	on request	on request	on request	on request	on request	on request	on request
Low Pressure transmitter	Ac	⑧	ET-398H275315							
Pressure gauge	Ac	⑩ ⑭	ET-398H354042							
Low pressure switch	Ac/Wc	⑪	ET-398H354061							
High pressure switch	Ac	⑬	ET-398H354060							
High Pressure transmitter	Ac	⑮	ET-398H275311							

COMPONENTS		See par. 8.5	PSE 1400	PSE 1600	PSE 2000	PSE 2400	PSE3000	PSE 3800	PSE 5000	PSE 6000
Water pressostatic valve	Wc P.T.	28.1	398H378209			398H378204	398H378204	398H378204	398H378204	398H378220
	Wc S&T	28.2	398H378202			398H378203	398H378204	398H378204	398H378204	398H378220
Safety Valve kit	Ac/Wc	30	-			-			398H473783	
Electronic card touch AVC6200	Ac/Wc	A1	398H473785							
Expansion EVE6000	Ac/Wc	-	398H473786							
Display touch	Ac	-	398H473788							
	Wc	-	398H473788Y001							
Hot gas valve control	Ac/Wc	-	398H473789							
Dew point/ evaporator temperature sensor	Ac/Wc	B0	398H275233							
Evaporation temperature sensor	Ac/Wc	B2	398H275233							
Ambient temperature sensor	Ac/Wc	B3	398H275233							
Suction temperature sensor	Ac/Wc	B5	398H275233							
Discharge temperature sensor	Ac/Wc	B8	398H275972							
Condensate level sensor	Ac/Wc	CS	398H275752							
Phases monitor	Ac/Wc	A4	398H256366			-				
Main disconnect switch	Ac/Wc	QS1	398H256424							
Compressor Automatic switch	Ac/Wc	QF1	398H256294		398H256363	ET-398H256201			ET-398H256200	
Compressor contactor	Ac/Wc	KM1	398H256246		398H256325	398H256296			ET-398H256251	
Fan contactor	Ac	KM2	398H256243							
Auxiliary transformer	Ac/Wc	TC1	ET-398H255854							
Condensate drain solenoid valve	Ac/Wc	16-17-18	398H698218							

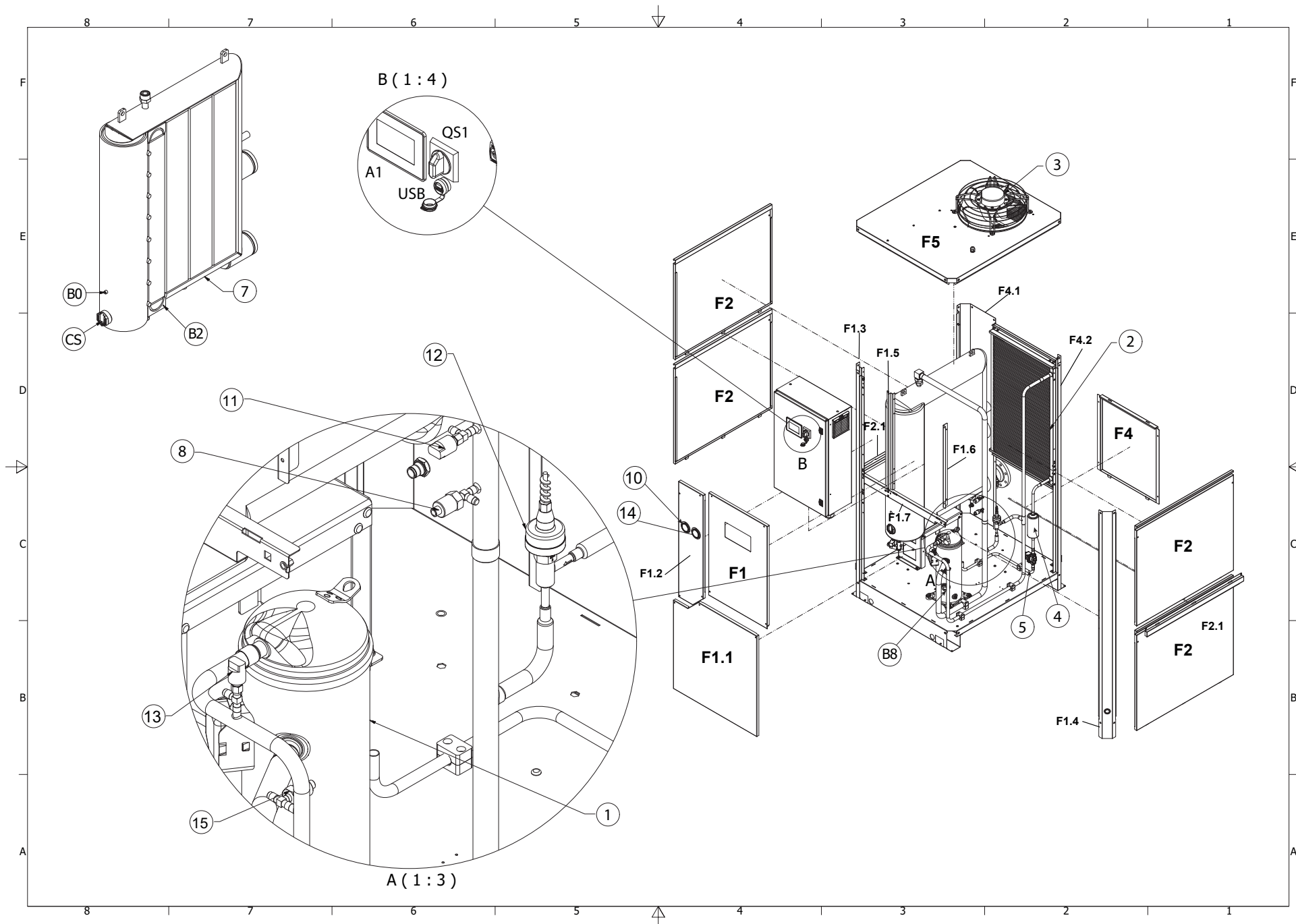

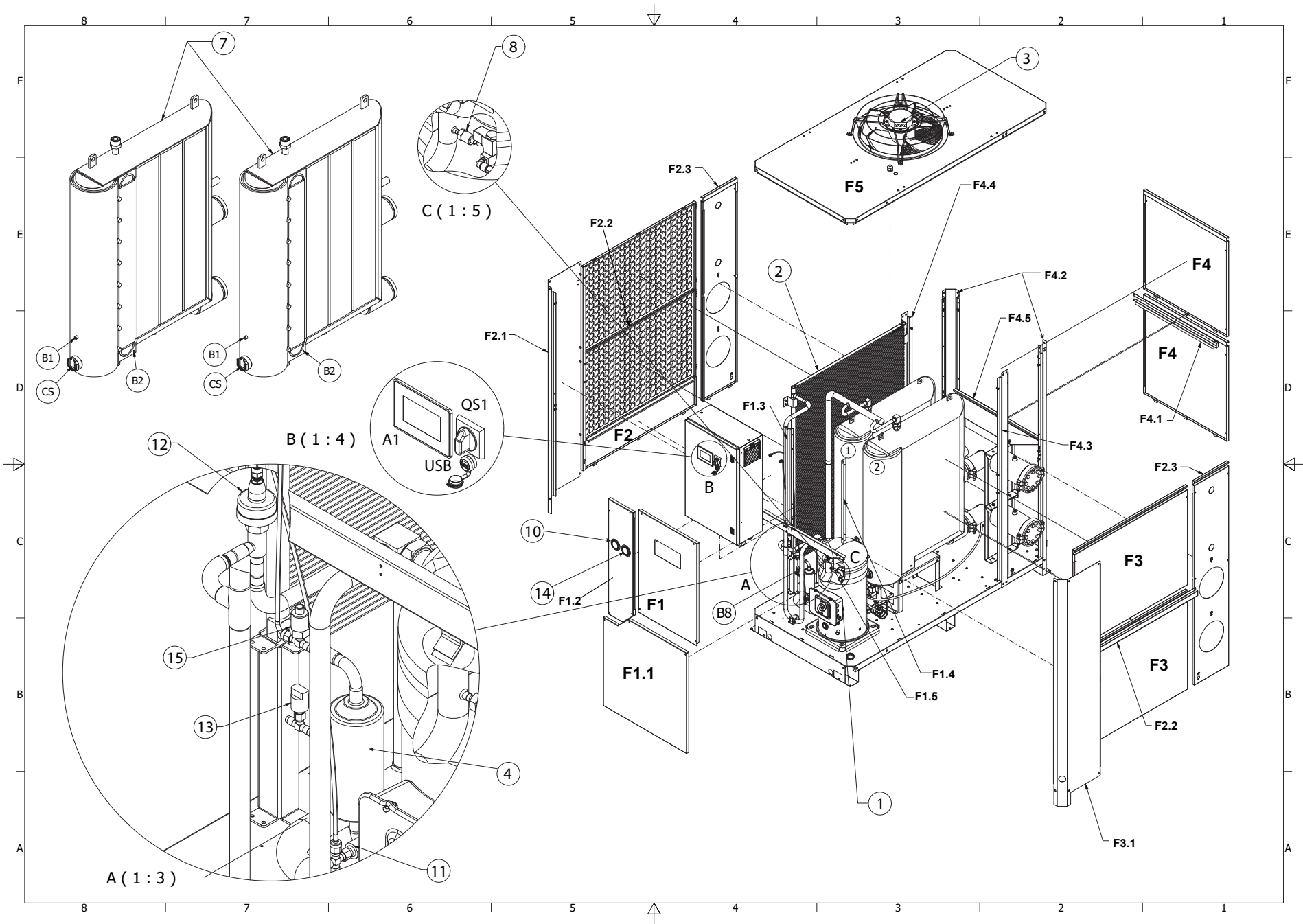

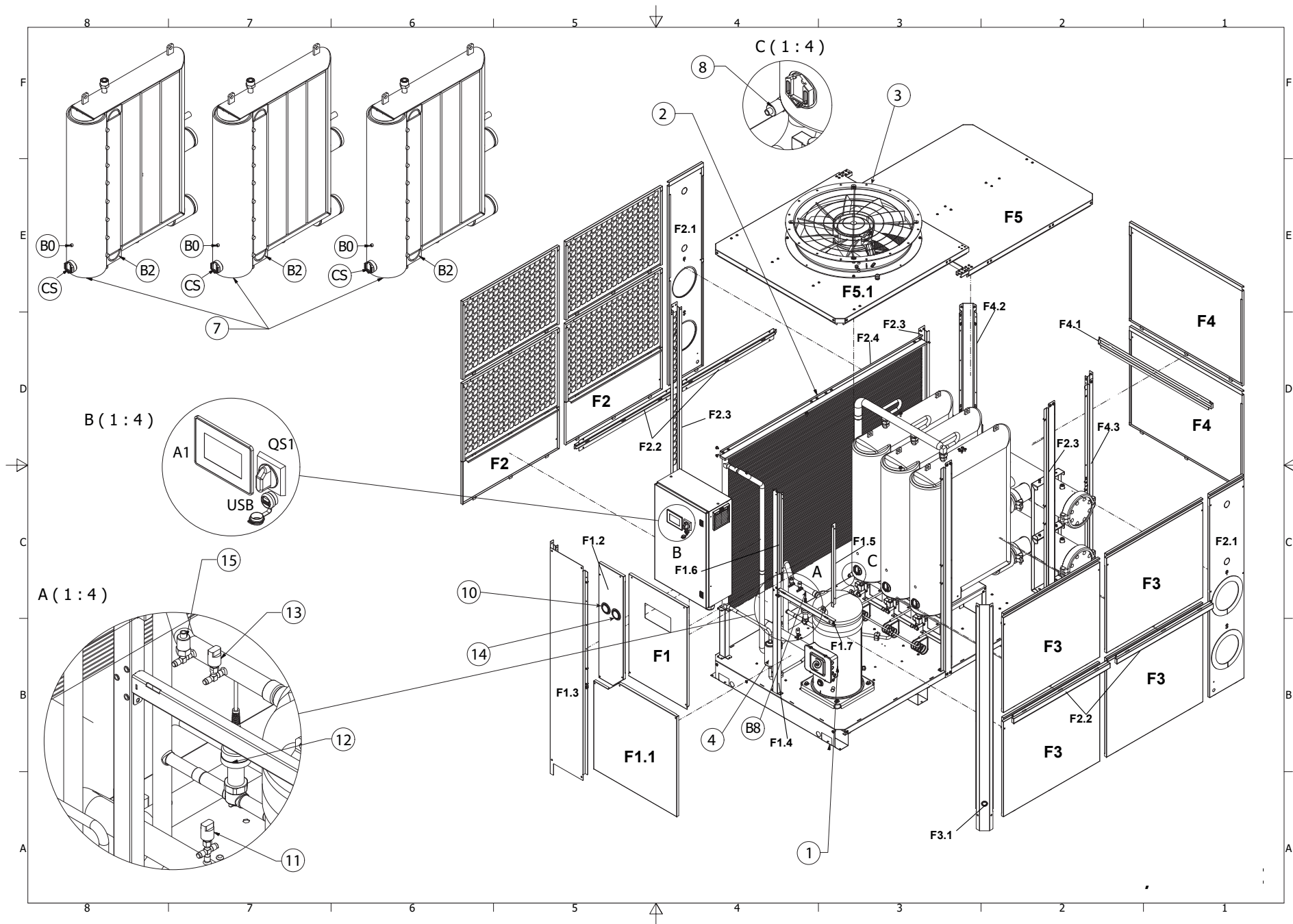

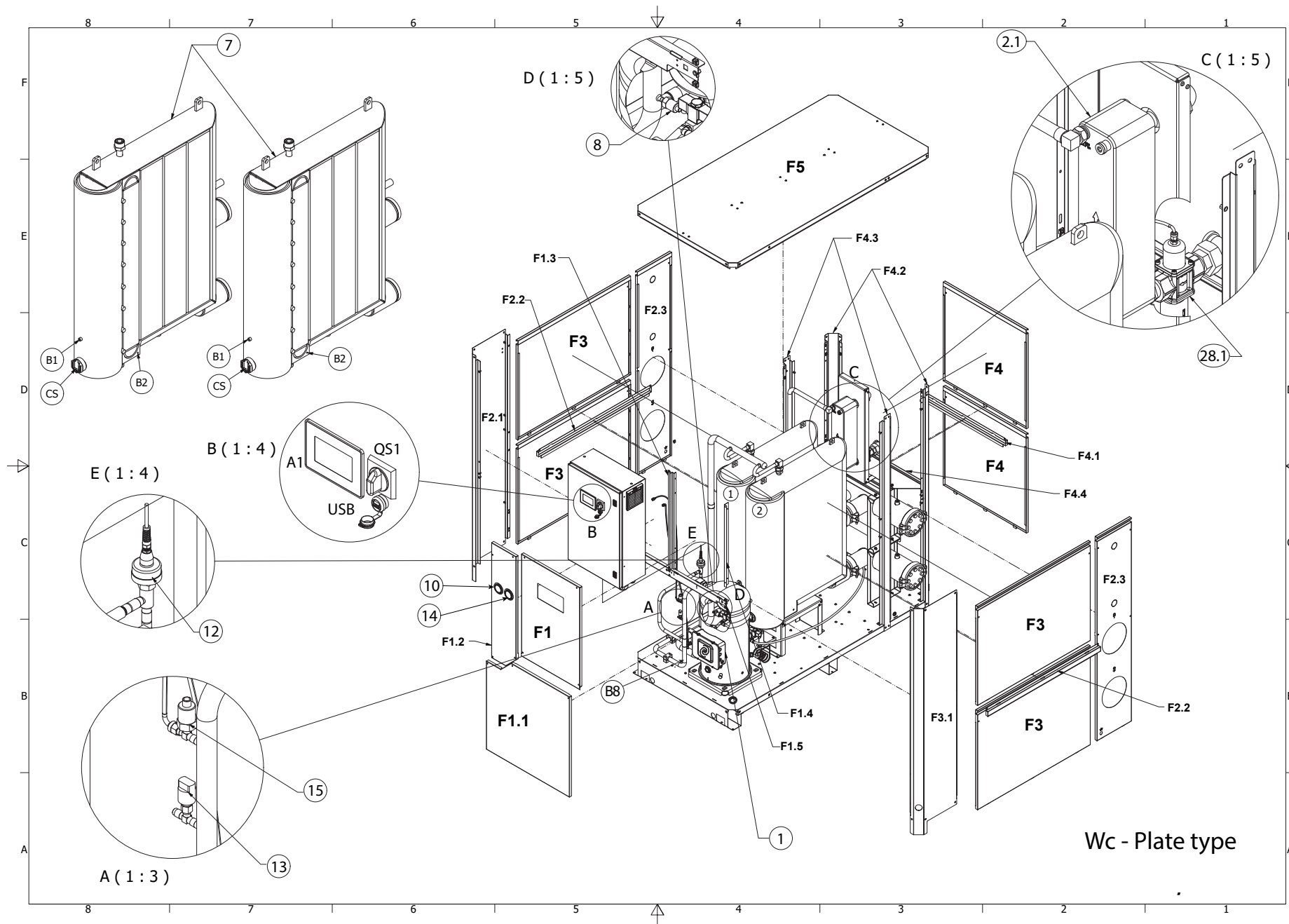

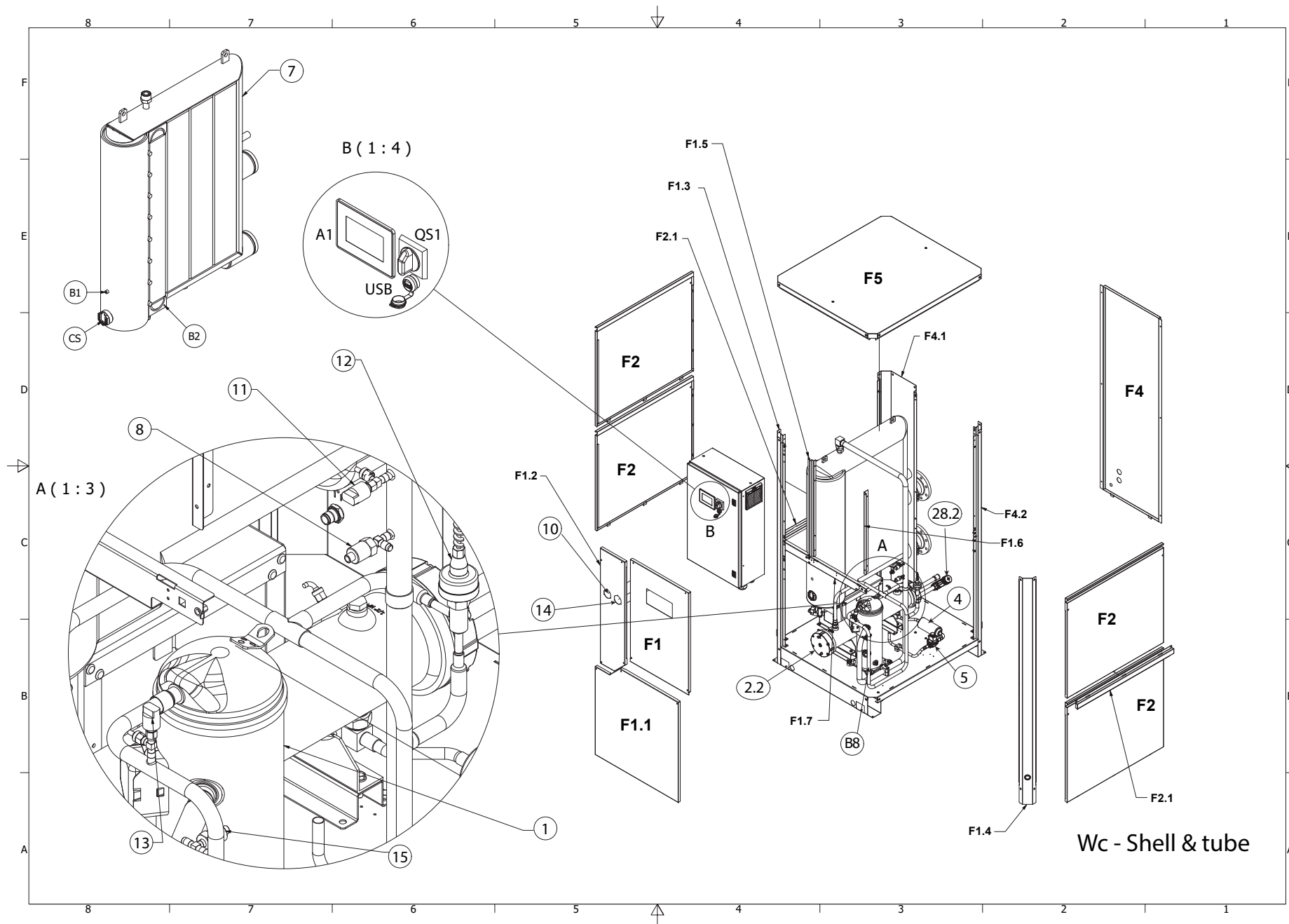

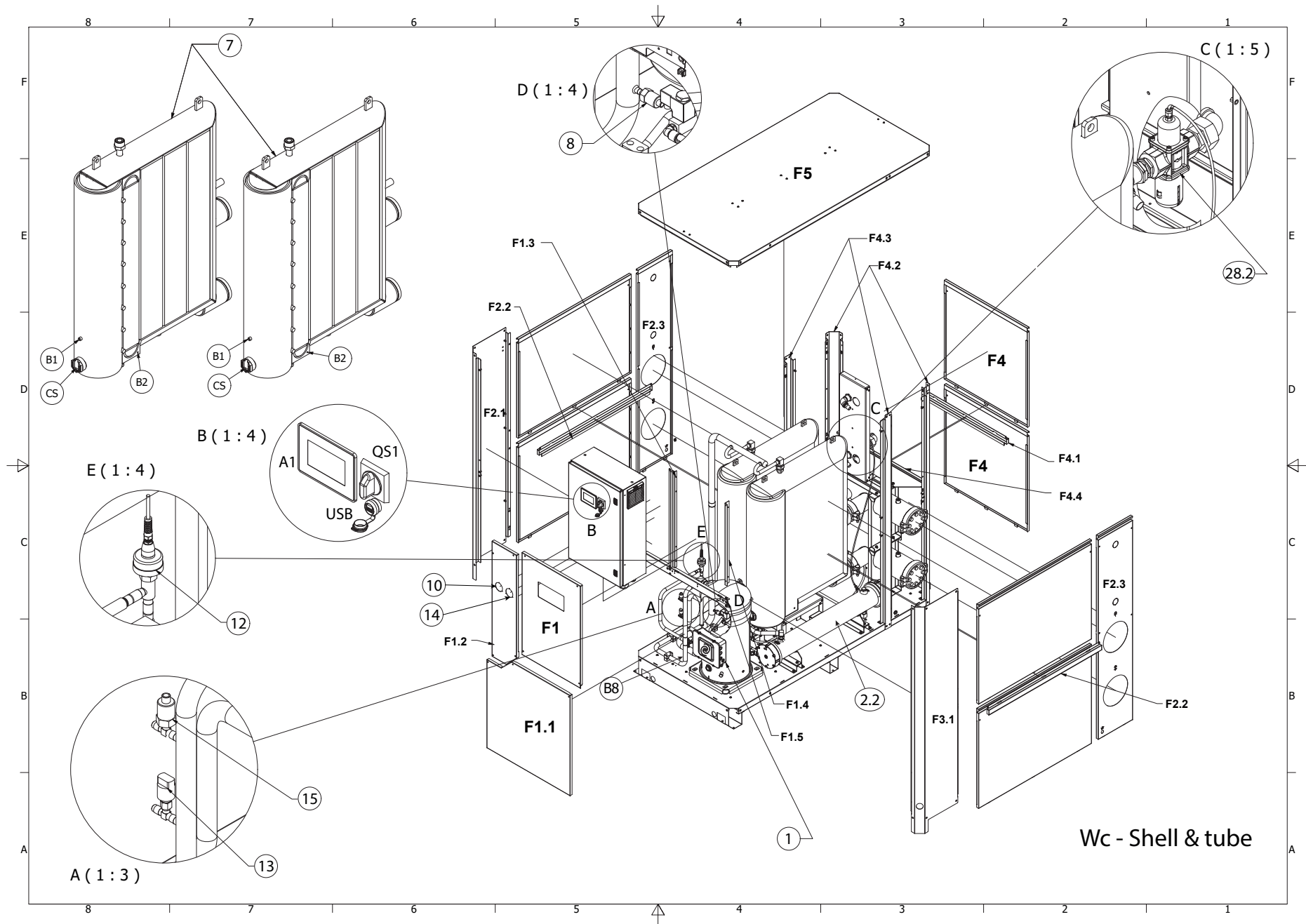

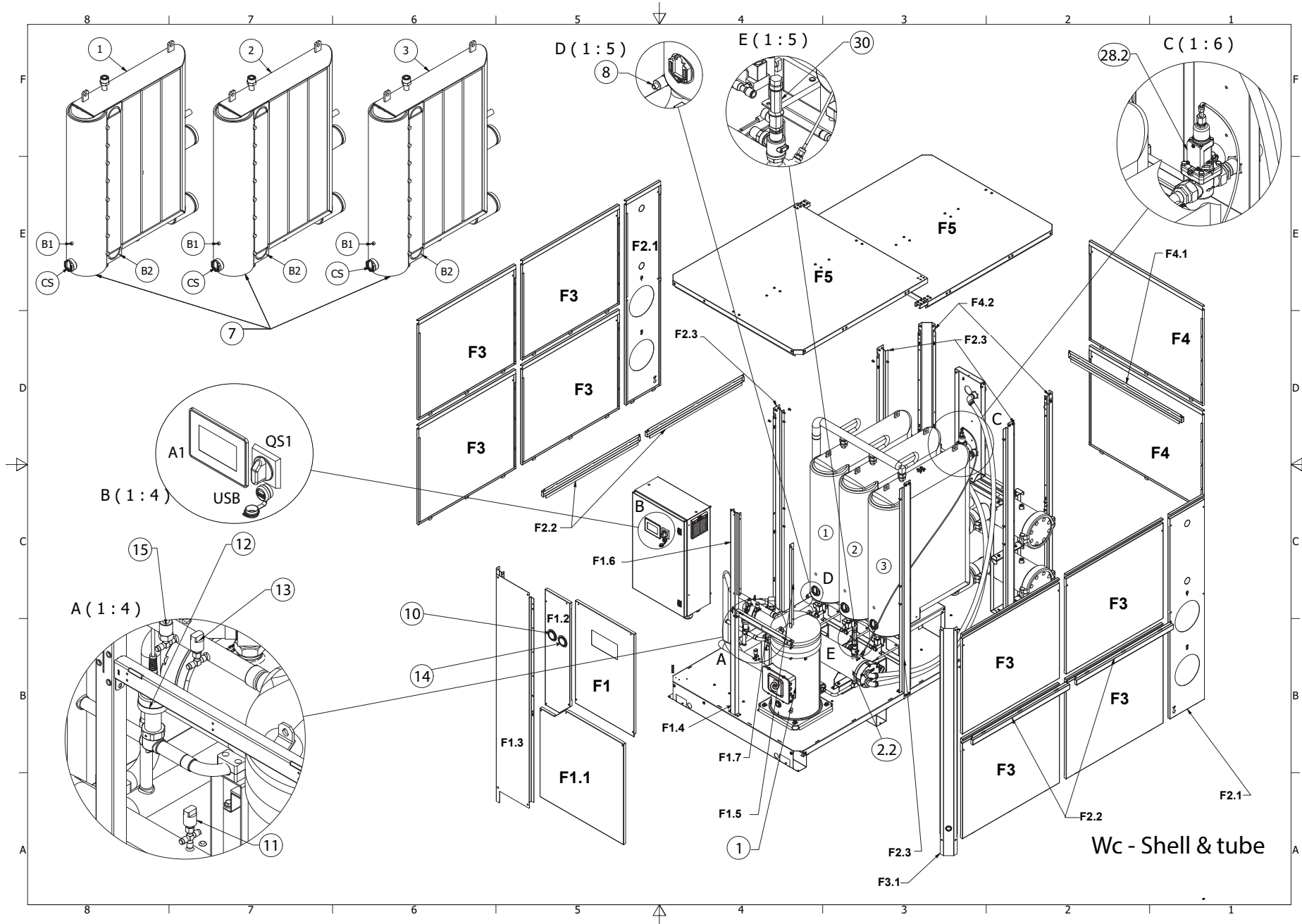

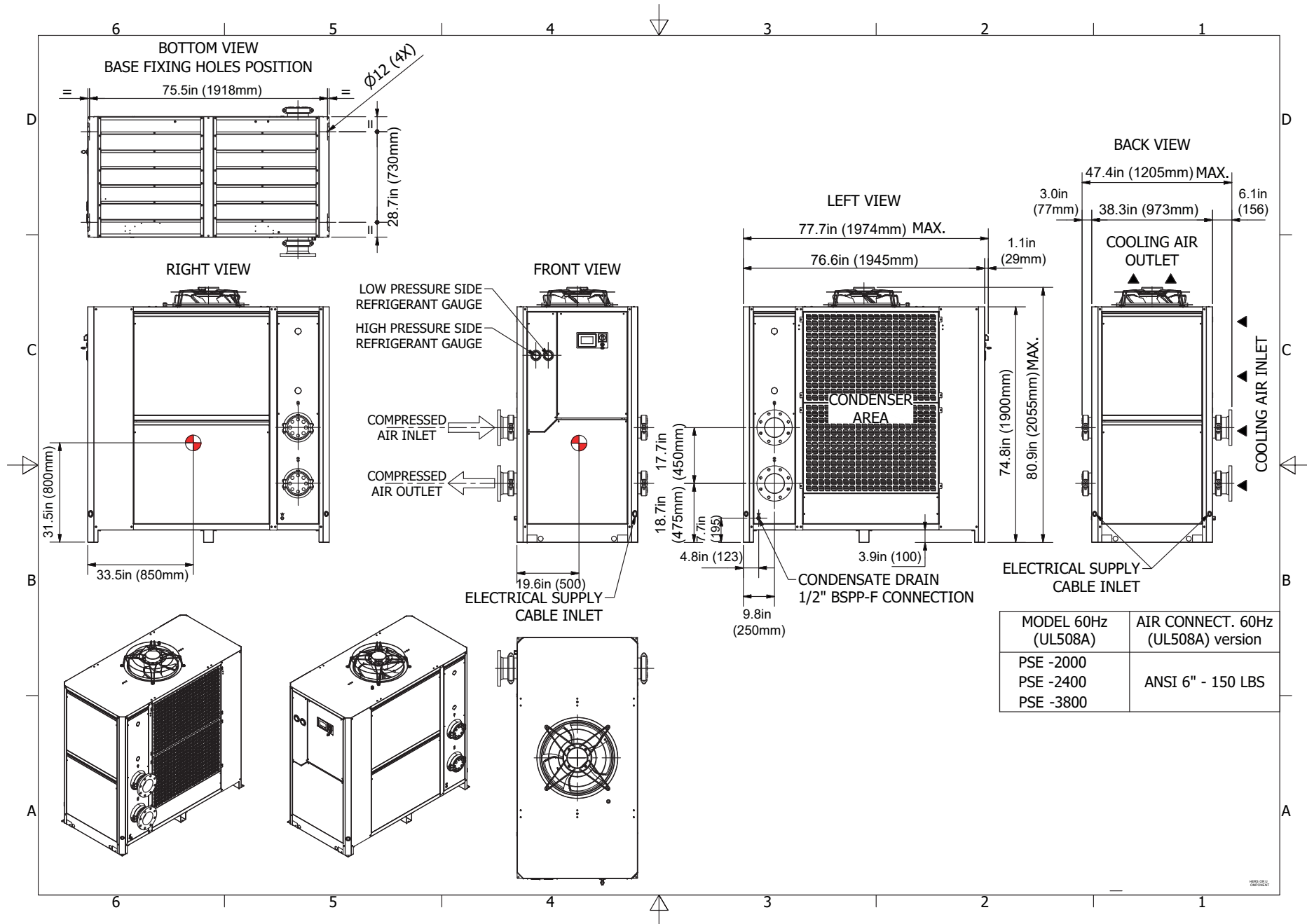

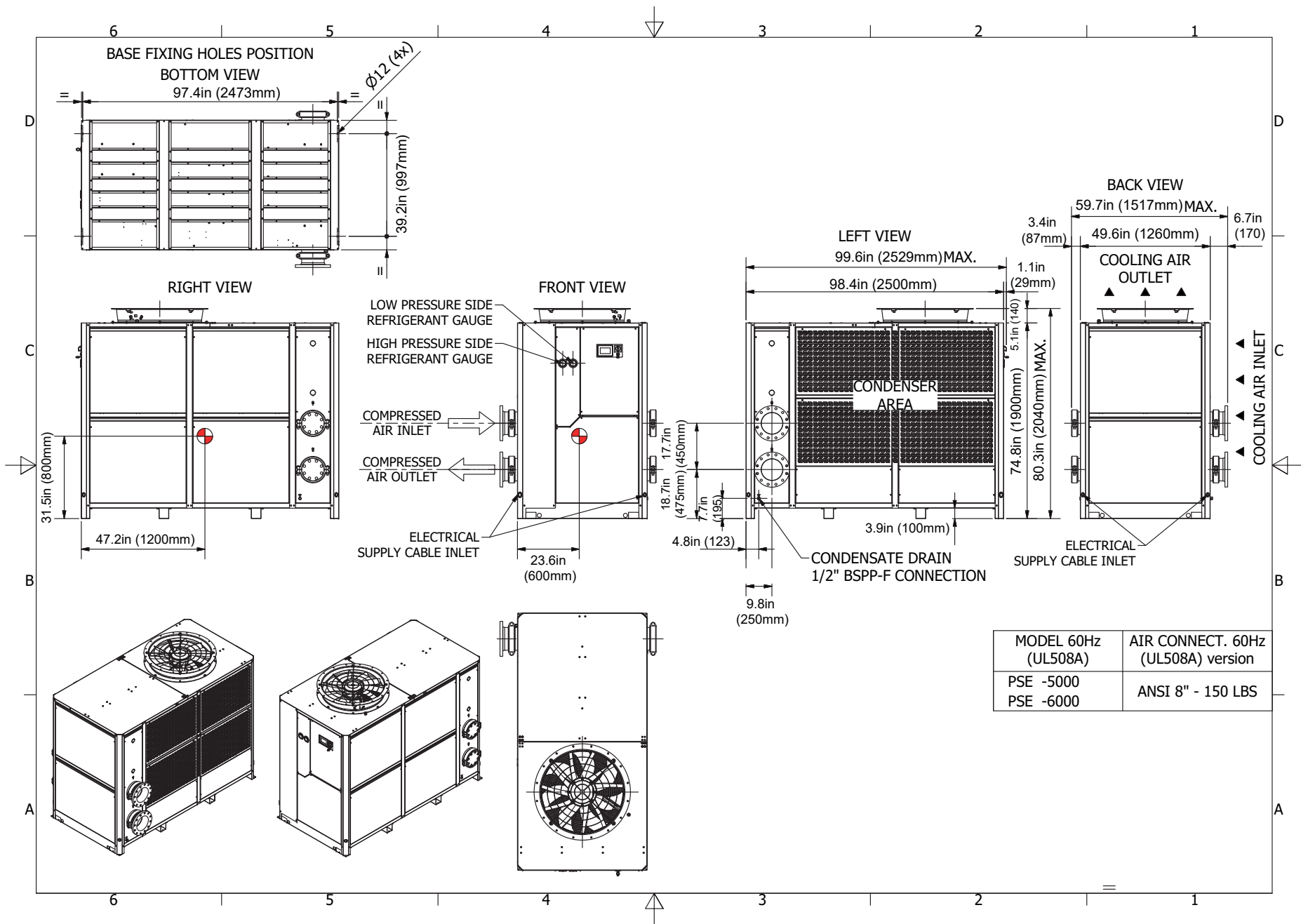

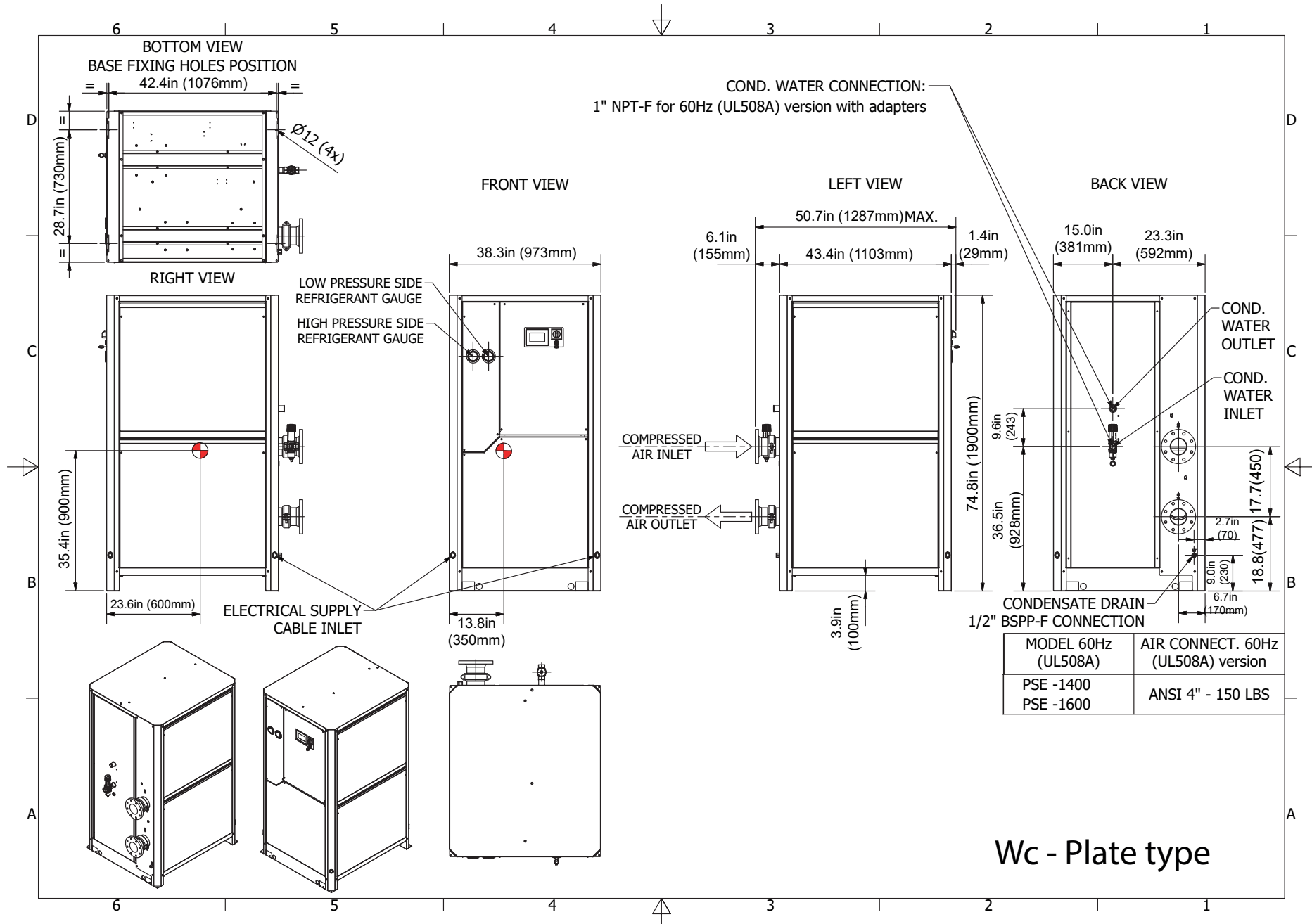

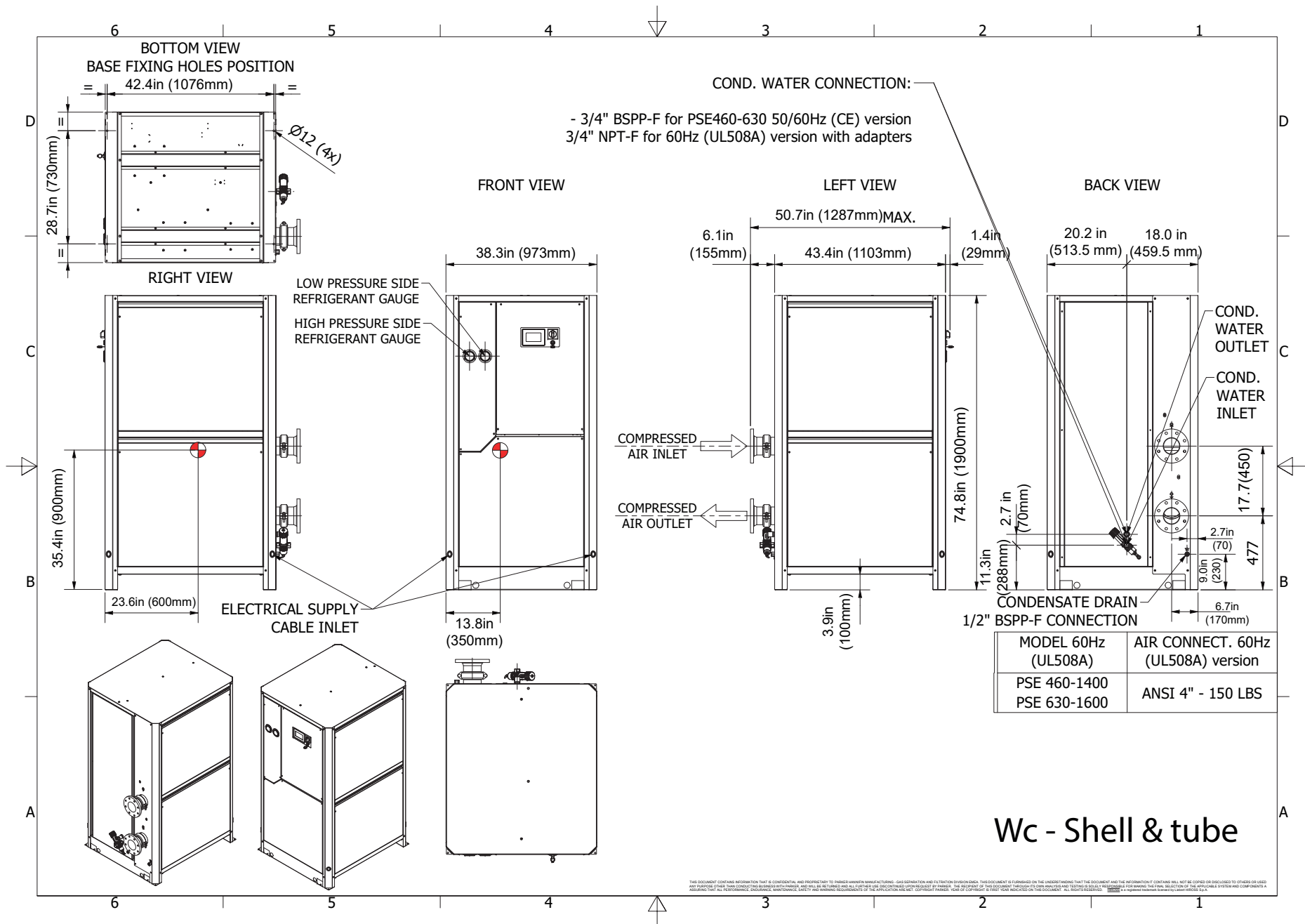

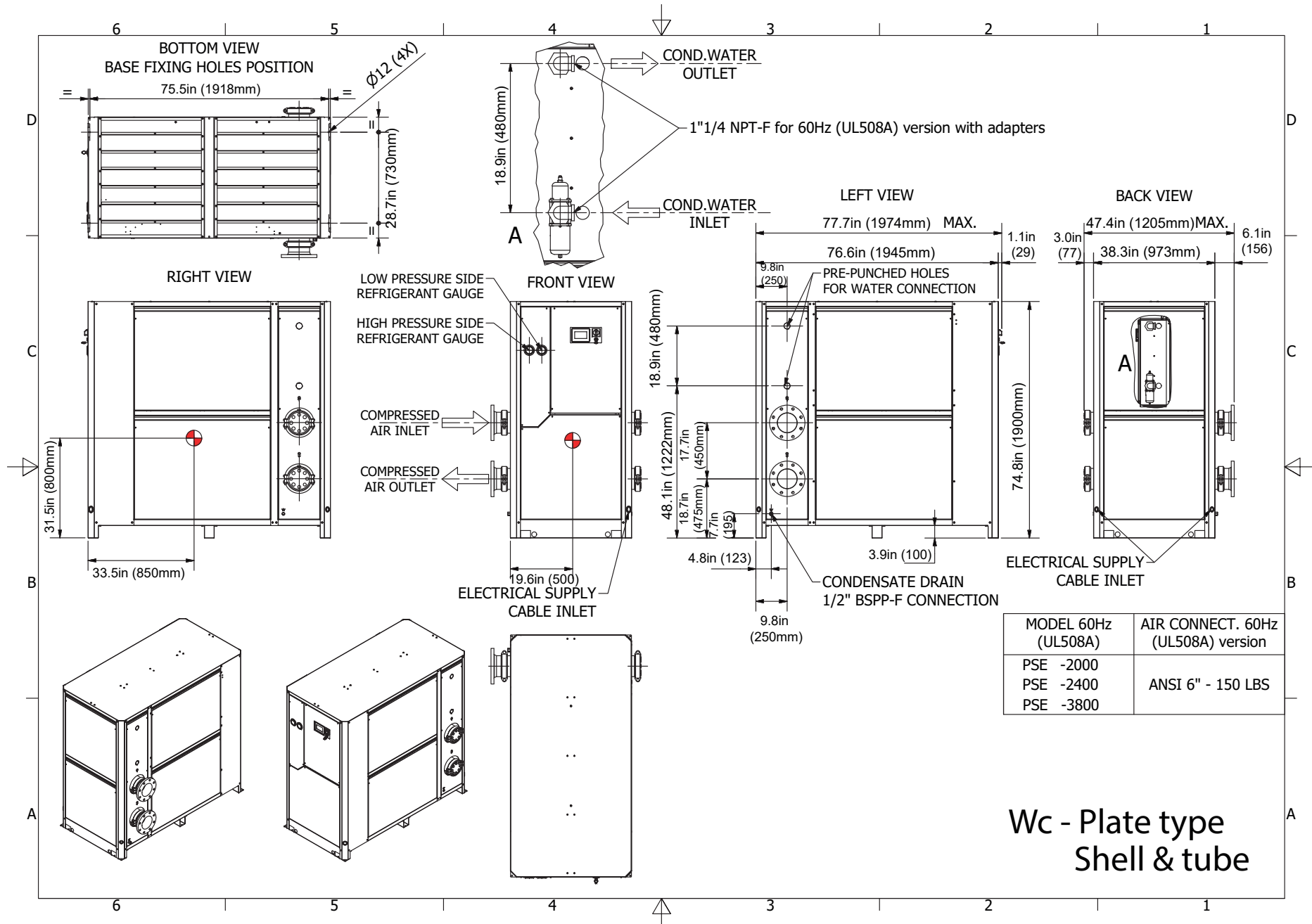

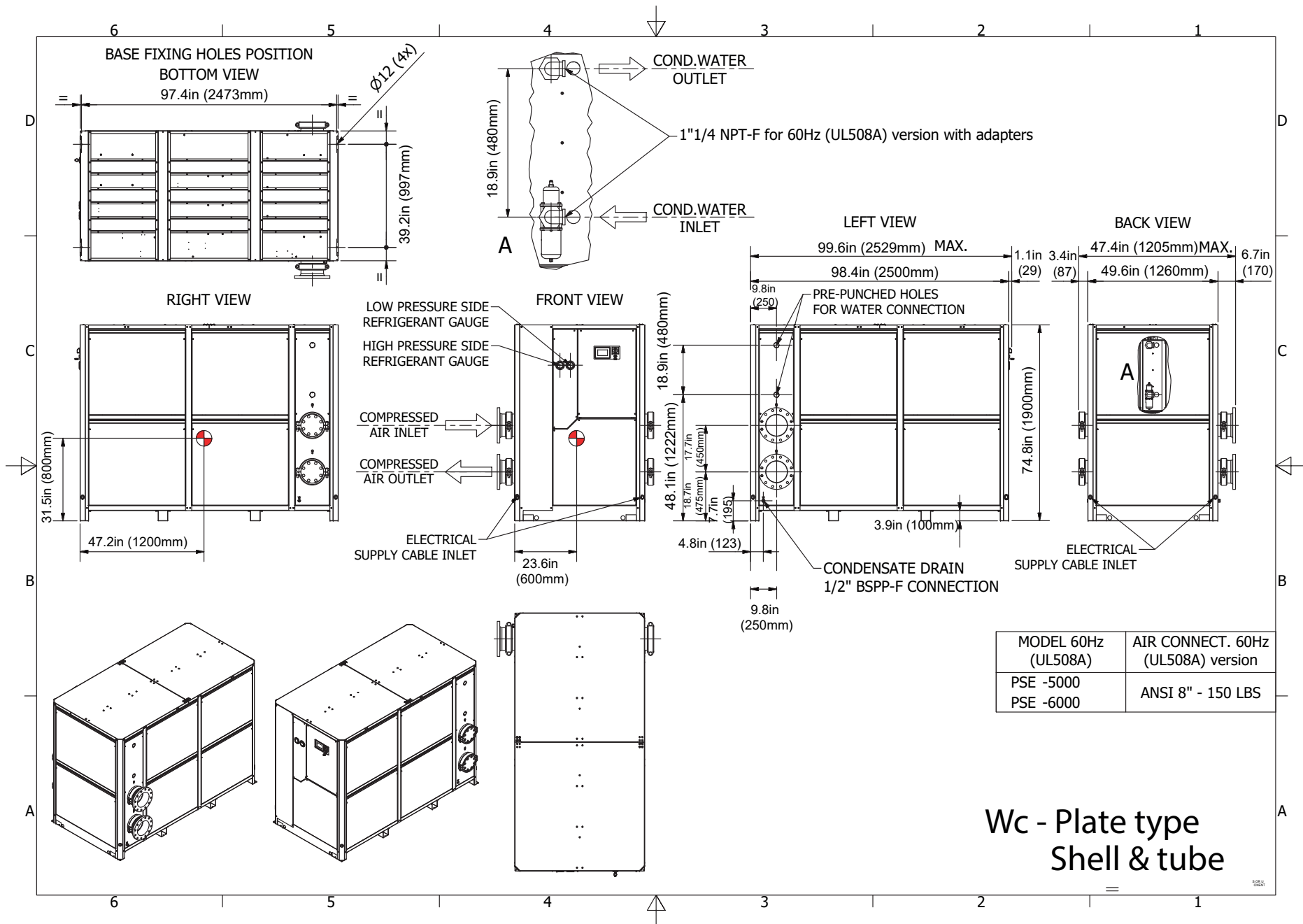

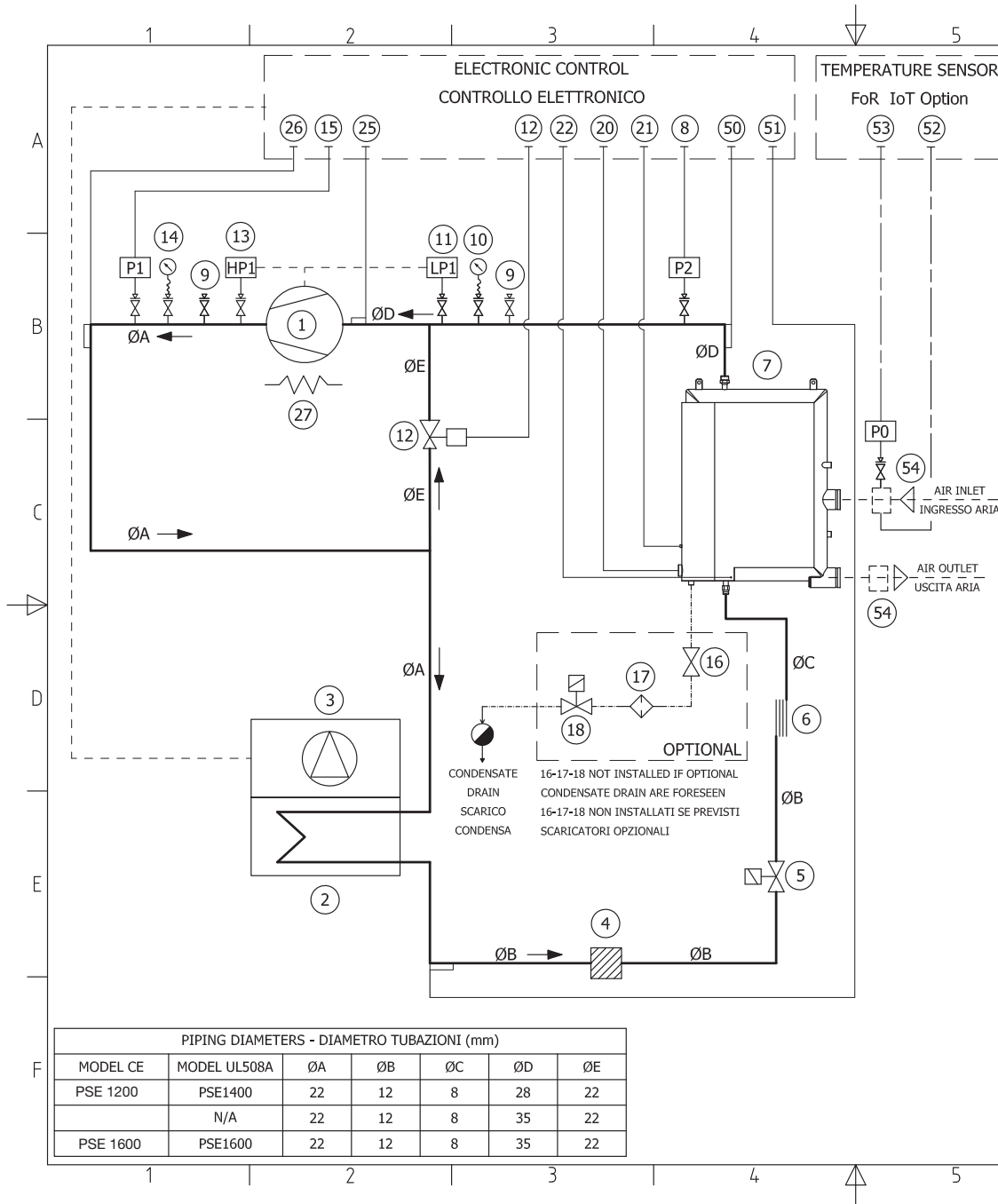

TEMPERATURE SENSOR FOR IoT Option			
54		AIR INLET OUTLET ADAPTER JOINT	GIUNTO INGRESSO USCITA ARIA
53	P0	AIR INLET PRESSURE SENSOR	TRASMETTITORE INGRESSO ARIA
52	B9	AIR INLET TEMPERATURE SENSOR	SONDA TEMP. INGRESSO ARIA

51	B7	OUTPUT CONDENSER SENSOR	SONDA USCITA CONDENSATORE
50	B6	OUTPUT EVAPORATOR SENSOR	SONDA USCITA EVAPORATORE
28			
27	EH1	CRANKCASE HEATER COMPRESSOR	RESISTENZA CARTER COMPRESSORE
26	B8	REFRIGER.DISCHARGE TEMP.SENSOR	SONDA TEMP.MANDATA REFRIGER.
25	B5	REFRIGER.SUCTION TEMP.SENSOR	SONDA TEMP.ASPIRAZ. REFRIGER.
24			
23			
22	B2	EVAPORATOR SENSOR	SONDA EVAPORATORE
21	B0	DEW POINT TEMPERATURE SENSOR	SONDA TEMP.PUNTO DI RUGIADA
20	CS3	CONDENSATE LEVEL SENSOR	SENSORE DI LIVELLO CONDENSA
19			
18	YV3	CONDENS,DRAIN SOLENOID VALVE	ELETTROVALV.SCARICO CONDENSA
17		CONDENSATE FILTER VALVE	FILTRO SCARICO CONDENSA
16		CONDENSATE DRAIN VALVE	RUBINETTO SCARICO CONDENSA
15	P1	HIGH PRESSURE TRANSMITTER	TRASMETTITORE ALTA PRESSIONE
14	HP1	HIGH PRESS.SIDE REFRIG.GAUGE	MANOMETRO ALTA PRESSIONE
13	HP1	HIGH PRESSURE SWITCH	PRESSOSTATO ALTA PRESSIONE
12	YV2	ELECTRONIC HOT GAS VALVE	VALVOLA GAS CALDO ELETTRONIC.
11	LP1	LOW PRESSURE SWITCH	PRESSOSTATO BASSA PRESSIONE
10		LOW PRESS.SIDE REFRIG.GAUGE	MANOMETRO BASSA PRESSIONE
9		PRESSURE CONNECTION	PRESA DI PRESSIONE
8	P2	LOW PRESSURE TRANSMITTER	TRASMETTITORE BASSA PRESSIONE
7		HEAT-EXCHANGER	SCAMBIATORE DI CALORE
6	C1	EXPANSION CAPILLARY	CAPILLARE ESPANSIONE
5	YV1	LIQUID LINE SOLENOID VALVE	ELETTROVALV.LINEA DI LIQUIDO
4		REFRIGERANT FILTER	FILTRO REFRIGERANTE
3	EV1	FAN	VENTILATORE
2		REFRIGERANT CONDENSER	CONDENSATORE REFRIGERANTE
1	MC	COMPRESSOR	COMPRESSORE
Pos.	Ref.	DESCRIPTION	DENOMINAZIONE

PIPING DIAMETERS - DIAMETRO TUBAZIONI (mm)						
MODEL CE	MODEL UL508A	ØA	ØB	ØC	ØD	ØE
PSE 1200	PSE1400	22	12	8	28	22
	N/A	22	12	8	35	22
PSE 1600	PSE1600	22	12	8	35	22

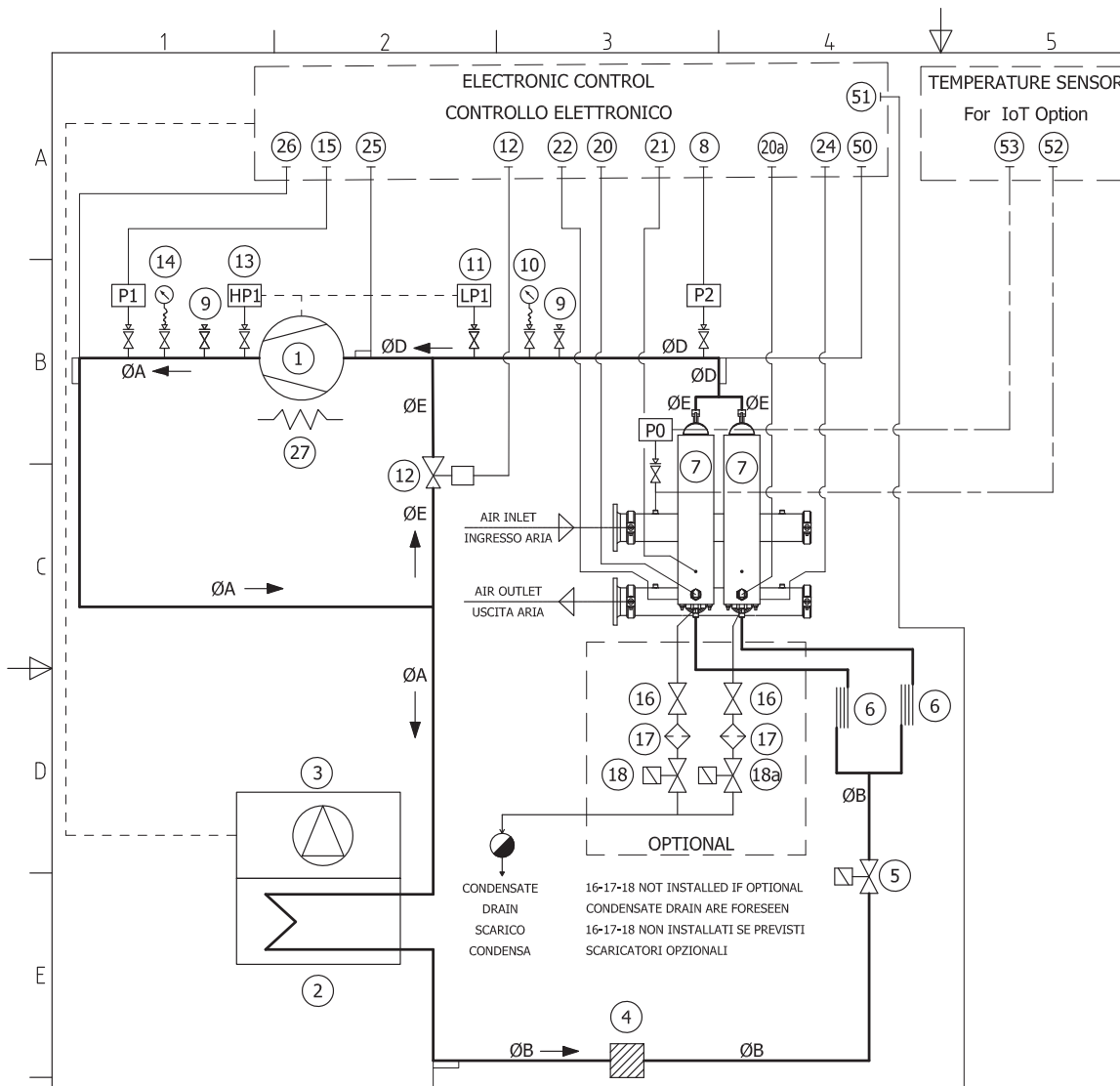

TEMPERATURE SENSOR FOR IoT OPTION			
53	P0	AIR INLET PRESSURE SENSOR	TRASMETTITORE INGRESSO ARIA
52	B9	AIR INLET TEMPERATURE SENSOR	SONDA TEMP. INGRESSO ARIA

51	B7	OUTPUT CONDENSER SENSOR	SONDA USCITA CONDENSATORE
50	B6	OUTPUT EVAPORATOR SENSOR	SONDA USCITA EVAPORATORE
28			
27	EH1	CRANKCASE HEATER COMPRESSOR	RESISTENZA CARTER COMPRESSORE
26	B8	REFRIGER.DISCHARGE TEMP.SENSOR	SONDA TEMP.MANDATA REFRIGER.
25	B5	REFRIGER.SUCTION TEMP.SENSOR	SONDA TEMP.ASPIRAZ. REFRIGER.
24	B4	EVAPORATOR SENSOR(Multicooler)	SONDA EVAPORATORE(Secondo evap)
23			
22	B2	EVAPORATOR SENSOR	SONDA EVAPORATORE
21	B0	DEW POINT TEMPERATURE SENSOR	SONDA TEMP.PUNTO DI RUGIADA
20a	CS4	CONDENSATE LEVEL SENSOR	SENSORE DI LIVELLO CONDENSA
20	CS3	CONDENSATE LEVEL SENSOR	SENSORE DI LIVELLO CONDENSA
19			
18a	YV4	CONDENS.DRAIN SOLENOID VALVE	ELETTROVALV.SCARICO CONDENSA
18	YV3	CONDENS.DRAIN SOLENOID VALVE	ELETTROVALV.SCARICO CONDENSA
17		CONDENSATE FILTER VALVE	FILTRO SCARICO CONDENSA
16		CONDENSATE DRAIN VALVE	RUBINETTO SCARICO CONDENSA
15	P1	HIGH PRESSURE TRANSMITTER	TRASMETTITORE ALTA PRESSIONE
14		HIGH PRESS.SIDE REFRIG.GAUGE	MANOMETRO ALTA PRESSIONE
13	HP1	HIGH PRESSURE SWITCH	PRESSOSTATO ALTA PRESSIONE
12	YV2	ELECTRONIC HOT GAS VALVE	VALVOLA GAS CALDO ELETTRONIC.
11	LP1	LOW PRESSURE SWITCH	PRESSOSTATO BASSA PRESSIONE
10		LOW PRESS.SIDE REFRIG.GAUGE	MANOMETRO BASSA PRESSIONE
9		PRESSURE CONNECTION	PRESA DI PRESSIONE
8	P2	LOW PRESSURE TRANSMITTER	TRASMETTITORE BASSA PRESSIONE
7		HEAT-EXCHANGER	SCAMBIATORE DI CALORE
6	C1	EXPANSION CAPILLARY	CAPILLARE ESPANSIONE
5	YV1	LIQUID LINE SOLENOID VALVE	ELETTROVALV.LINEA DI LIQUIDO
4		REFRIGERANT FILTER	FILTRO REFRIGERANTE
3	EV1	FAN	VENTILATORE
2		REFRIGERANT CONDENSER	CONDENSATORE REFRIGERANTE
1	MC	COMPRESSOR	COMPRESSORE
Pos.	Ref.	DESCRIPTION	DENOMINAZIONE

PIPING DIAMETERS - DIAMETRO TUBAZIONI (mm)						
MODEL CE	MODEL UL508a	ØA	ØB	ØC	ØD	ØE
PSE 2000	PSE2000	22	12	8	28	22
PSE 2400	PSE2400	22	12	8	35	22
PSE 3800	PSE3000-3800	22	12	8	35	22

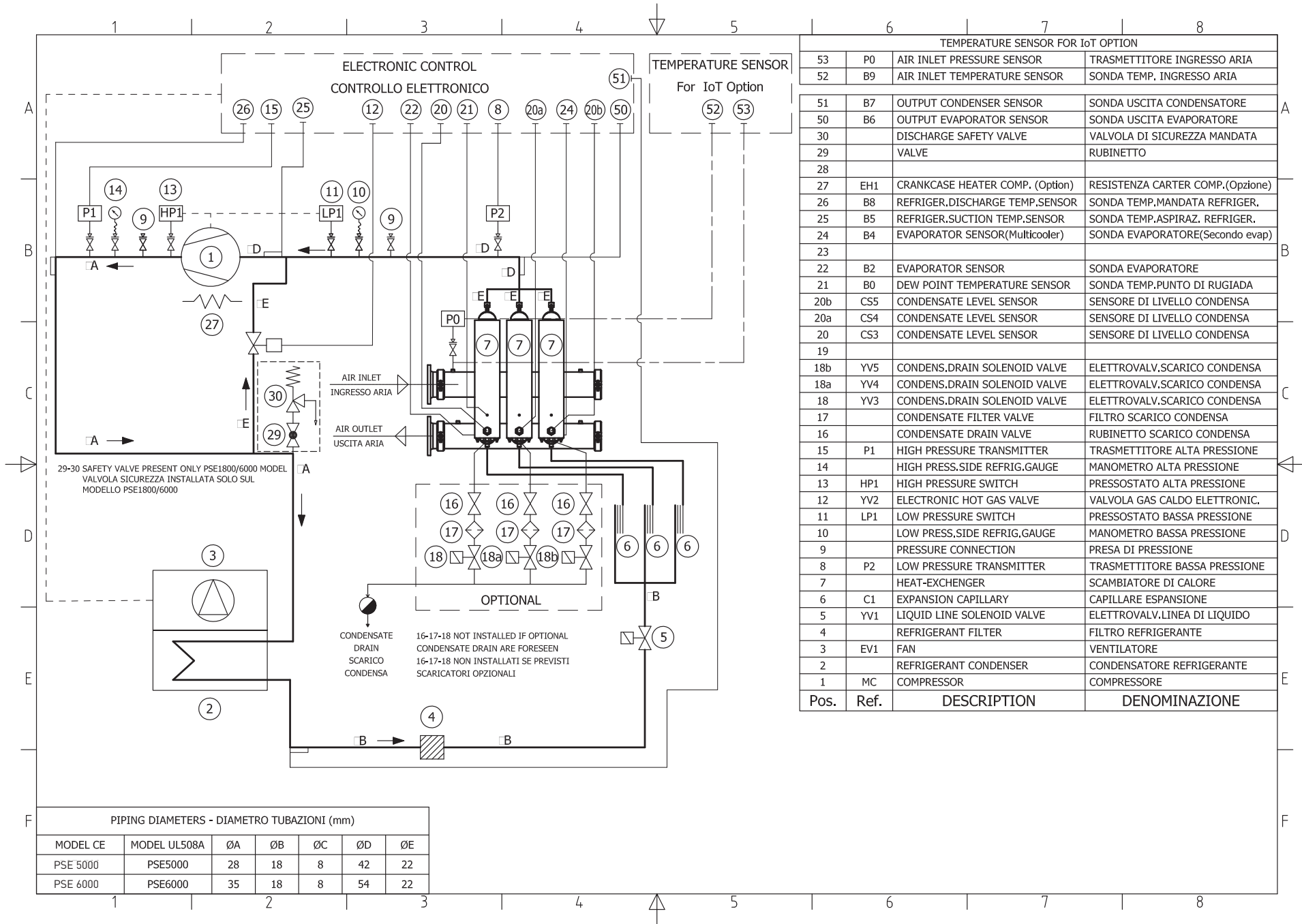

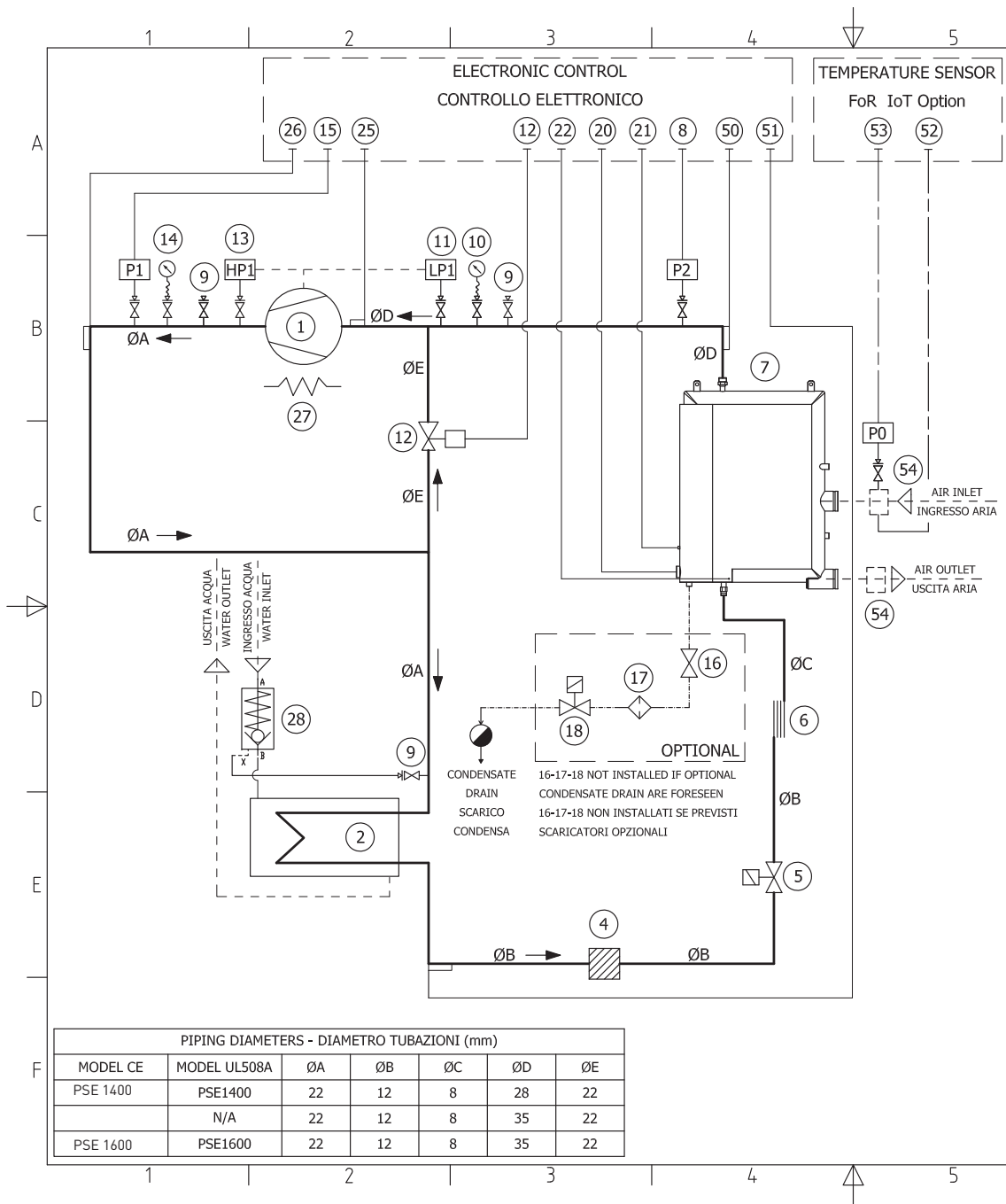

TEMPERATURE SENSOR FOR IoT Option			
54		AIR INLET OUTLET ADAPTER JOINT	GIUNTO INGRESSO USCITA ARIA
53	P0	AIR INLET PRESSURE SENSOR	TRASMETTITORE INGRESSO ARIA
52	B9	AIR INLET TEMPERATURE SENSOR	SONDA TEMP. INGRESSO ARIA

51	B7	OUTPUT CONDENSER SENSOR	SONDA USCITA CONDENSATORE
50	B6	OUTPUT EVAPORATOR SENSOR	SONDA USCITA EVAPORATORE
28		WATER PRESSOSTATIC VALVE	VALVOLA PRESSOSTATICA ACQUA
27	EH1	CRANKCASE HEATER COMPRESSOR	RESISTENZA CARTER COMPRESSORE
26	B8	REFRIGER.DISCHARGE TEMP.SENSOR	SONDA TEMP.MANDATA REFRIGER.
25	B5	REFRIGER.SUCTION TEMP.SENSOR	SONDA TEMP.ASPIRAZ. REFRIGER.
24			
23			
22	B2	EVAPORATOR SENSOR	SONDA EVAPORATORE
21	B0	DEW POINT TEMPERATURE SENSOR	SONDA TEMP.PUNTO DI RUGIADA
20	CS3	CONDENSATE LEVEL SENSOR	SENSORE DI LIVELLO CONDENSA
19			
18	YV3	CONDENS.DRAIN SOLENOID VALVE	ELETTROVALV.SCARICO CONDENSA
17		CONDENSATE FILTER VALVE	FILTRO SCARICO CONDENSA
16		CONDENSATE DRAIN VALVE	RUBINETTO SCARICO CONDENSA
15	P1	HIGH PRESSURE TRANSMITTER	TRASMETTITORE ALTA PRESSIONE
14		HIGH PRESS.SIDE REFRIG.GAUGE	MANOMETRO ALTA PRESSIONE
13	HP1	HIGH PRESSURE SWITCH	PRESSOSTATO ALTA PRESSIONE
12	YV2	ELECTRONIC HOT GAS VALVE	VALVOLA GAS CALDO ELETTRONIC.
11	LP1	LOW PRESSURE SWITCH	PRESSOSTATO BASSA PRESSIONE
10		LOW PRESS.SIDE REFRIG.GAUGE	MANOMETRO BASSA PRESSIONE
9		PRESSURE CONNECTION	PRESA DI PRESSIONE
8	P2	LOW PRESSURE TRANSMITTER	TRASMETTITORE BASSA PRESSIONE
7		HEAT-EXCHANGER	SCAMBIATORE DI CALORE
6	C1	EXPANSION CAPILLARY	CAPILLARE ESPANSIONE
5	YV1	LIQUID LINE SOLENOID VALVE	ELETTROVALV.LINEA DI LIQUIDO
4		REFRIGERANT FILTER	FILTRO REFRIGERANTE
3	EV1	FAN	VENTILATORE
2		REFRIGERANT CONDENSER	CONDENSATORE REFRIGERANTE
1	MC	COMPRESSOR	COMPRESSORE
Pos.	Ref.	DESCRIPTION	DENOMINAZIONE

PIPING DIAMETERS - DIAMETRO TUBAZIONI (mm)						
MODEL CE	MODEL UL508A	ØA	ØB	ØC	ØD	ØE
PSE 1400	PSE1400	22	12	8	28	22
	N/A	22	12	8	35	22
PSE 1600	PSE1600	22	12	8	35	22

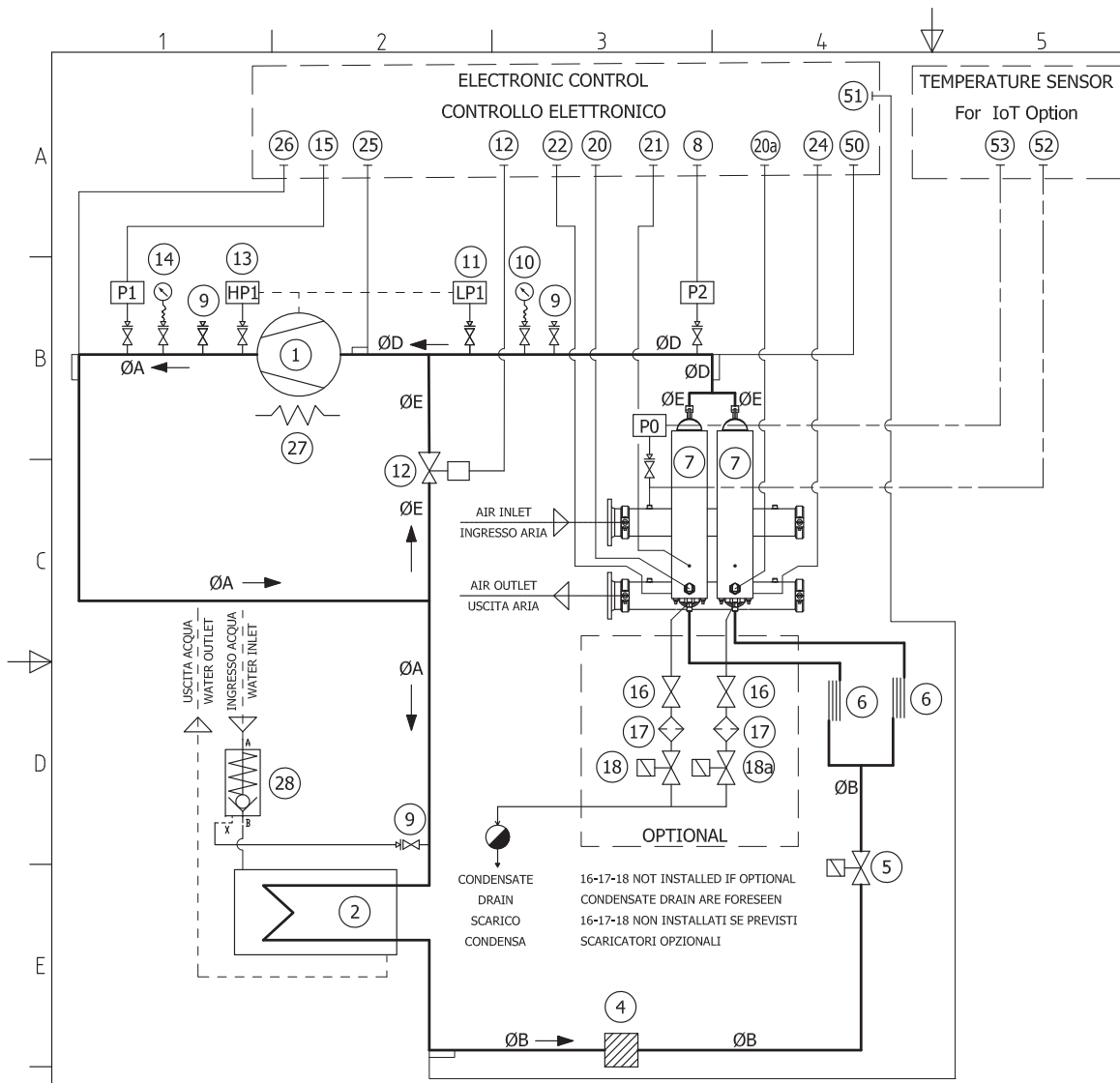

TEMPERATURE SENSOR FOR IoT OPTION			
53	P0	AIR INLET PRESSURE SENSOR	TRASMETTITORE INGRESSO ARIA
52	B9	AIR INLET TEMPERATURE SENSOR	SONDA TEMP. INGRESSO ARIA

51	B7	OUTPUT CONDENSER SENSOR	SONDA USCITA CONDENSATORE
50	B6	OUTPUT EVAPORATOR SENSOR	SONDA USCITA EVAPORATORE
28		WATER PRESSOSTATIC VALVE	VALVOLA PRESSOSTATICA ACQUA
27	EH1	CRANKCASE HEATER COMPRESSOR	RESISTENZA CARTER COMPRESSORE
26	B8	REFRIGER. DISCHARGE TEMP. SENSOR	SONDA TEMP. MANDATA REFRIGER.
25	B5	REFRIGER. SUCTION TEMP. SENSOR	SONDA TEMP. ASPIRAZ. REFRIGER.
24	B4	EVAPORATOR SENSOR (Multicooler)	SONDA EVAPORATORE (Secondo evap)
23			
22	B2	EVAPORATOR SENSOR	SONDA EVAPORATORE
21	B0	DEW POINT TEMPERATURE SENSOR	SONDA TEMP. PUNTO DI RUGIADA
20a	CS4	CONDENSATE LEVEL SENSOR	SENSORE DI LIVELLO CONDENSA
20	CS3	CONDENSATE LEVEL SENSOR	SENSORE DI LIVELLO CONDENSA
19			
18a	YV4	CONDENS. DRAIN SOLENOID VALVE	ELETTROVALV. SCARICO CONDENSA
18	YV3	CONDENS. DRAIN SOLENOID VALVE	ELETTROVALV. SCARICO CONDENSA
17		CONDENSATE FILTER VALVE	FILTRO SCARICO CONDENSA
16		CONDENSATE DRAIN VALVE	RUBINETTO SCARICO CONDENSA
15	P1	HIGH PRESSURE TRANSMITTER	TRASMETTITORE ALTA PRESSIONE
14		HIGH PRESS. SIDE REFRIG. GAUGE	MANOMETRO ALTA PRESSIONE
13	HP1	HIGH PRESSURE SWITCH	PRESSOSTATO ALTA PRESSIONE
12	YV2	ELECTRONIC HOT GAS VALVE	VALVOLA GAS CALDO ELETTRONIC.
11	LP1	LOW PRESSURE SWITCH	PRESSOSTATO BASSA PRESSIONE
10		LOW PRESS. SIDE REFRIG. GAUGE	MANOMETRO BASSA PRESSIONE
9		PRESSURE CONNECTION	PRESA DI PRESSIONE
8	P2	LOW PRESSURE TRANSMITTER	TRASMETTITORE BASSA PRESSIONE
7		HEAT-EXCHANGER	SCAMBIATORE DI CALORE
6	C1	EXPANSION CAPILLARY	CAPILLARE ESPANSIONE
5	YV1	LIQUID LINE SOLENOID VALVE	ELETTROVALV. LINEA DI LIQUIDO
4		REFRIGERANT FILTER	FILTRO REFRIGERANTE
3			
2		REFRIGERANT CONDENSER	CONDENSATORE REFRIGERANTE
1	MC	COMPRESSOR	COMPRESSORE
Pos.	Ref.	DESCRIPTION	DENOMINAZIONE

PIPING DIAMETERS - DIAMETRO TUBAZIONI (mm)

MODEL CE	MODEL UL508a	ØA	ØB	ØC	ØD	ØE
PSE 2000	PSE2000	22	12	8	28	22
PSE 2400	PSE2400	22	12	8	35	22
PSE 3800	PSE3000-3800	22	12	8	35	22

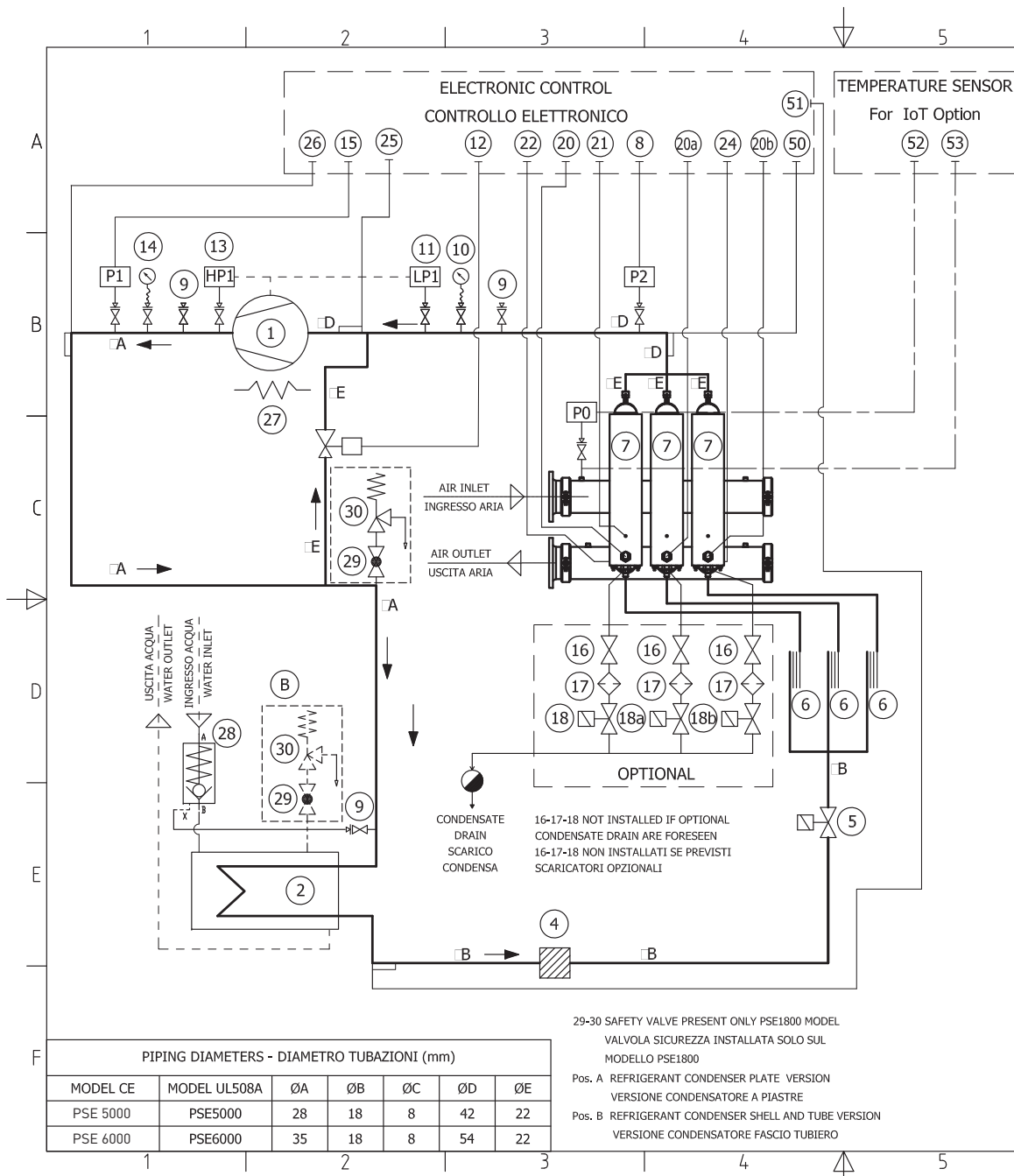

TEMPERATURE SENSOR FOR IoT OPTION			
53	P0	AIR INLET PRESSURE SENSOR	TRASMETTITORE INGRESSO ARIA
52	B9	AIR INLET TEMPERATURE SENSOR	SONDA TEMP. INGRESSO ARIA
51	B7	OUTPUT CONDENSER SENSOR	SONDA USCITA CONDENSATORE
50	B6	OUTPUT EVAPORATOR SENSOR	SONDA USCITA EVAPORATORE
30		DISCHARGE SAFETY VALVE	VALVOLA DI SICUREZZA MANDATA
29		VALVE	RUBINETTO
28			
27	EH1	CRANKCASE HEATER COMP. (Option)	RESISTENZA CARTER COMP.(Opzione)
26	B8	REFRIGER.DISCHARGE TEMP.SENSOR	SONDA TEMP.MANDATA REFRIGER.
25	B5	REFRIGER.SUCTION TEMP.SENSOR	SONDA TEMP.ASPIRAZ. REFRIGER.
24	B4	EVAPORATOR SENSOR(Multicooler)	SONDA EVAPORATORE(Secondo evap)
23			
22	B2	EVAPORATOR SENSOR	SONDA EVAPORATORE
21	B0	DEW POINT TEMPERATURE SENSOR	SONDA TEMP.PUNTO DI RUGIADA
20b	CS5	CONDENSATE LEVEL SENSOR	SENSORE DI LIVELLO CONDENSA
20a	CS4	CONDENSATE LEVEL SENSOR	SENSORE DI LIVELLO CONDENSA
20	CS3	CONDENSATE LEVEL SENSOR	SENSORE DI LIVELLO CONDENSA
19			
18b	YV5	CONDENS.DRAIN SOLENOID VALVE	ELETTROVALV.SCARICO CONDENSA
18a	YV4	CONDENS.DRAIN SOLENOID VALVE	ELETTROVALV.SCARICO CONDENSA
18	YV3	CONDENS.DRAIN SOLENOID VALVE	ELETTROVALV.SCARICO CONDENSA
17		CONDENSATE FILTER VALVE	FILTRO SCARICO CONDENSA
16		CONDENSATE DRAIN VALVE	RUBINETTO SCARICO CONDENSA
15	P1	HIGH PRESSURE TRANSMITTER	TRASMETTITORE ALTA PRESSIONE
14		HIGH PRESS.SIDE REFRIG.GAUGE	MANOMETRO ALTA PRESSIONE
13	HP1	HIGH PRESSURE SWITCH	PRESSOSTATO ALTA PRESSIONE
12	YV2	ELECTRONIC HOT GAS VALVE	VALVOLA GAS CALDO ELETTRONIC.
11	LP1	LOW PRESSURE SWITCH	PRESSOSTATO BASSA PRESSIONE
10		LOW PRESS.SIDE REFRIG.GAUGE	MANOMETRO BASSA PRESSIONE
9		PRESSURE CONNECTION	PRESA DI PRESSIONE
8	P2	LOW PRESSURE TRANSMITTER	TRASMETTITORE BASSA PRESSIONE
7		HEAT-EXCHANGER	SCAMBIATORE DI CALORE
6	C1	EXPANSION CAPILLARY	CAPILLARE ESPANSIONE
5	YV1	LIQUID LINE SOLENOID VALVE	ELETTROVALV.LINEA DI LIQUIDO
4		REFRIGERANT FILTER	FILTRO REFRIGERANTE
3			
2		REFRIGERANT CONDENSER	CONDENSATORE REFRIGERANTE
1	MC	COMPRESSOR	COMPRESSORE
Pos.	Ref.	DESCRIPTION	DENOMINAZIONE

PIPING DIAMETERS - DIAMETRO TUBAZIONI (mm)

MODEL CE	MODEL UL508A	ØA	ØB	ØC	ØD	ØE
PSE 5000	PSE5000	28	18	8	42	22
PSE 6000	PSE6000	35	18	8	54	22

29-30 SAFETY VALVE PRESENT ONLY PSE1800 MODEL
VALVOLA SICUREZZA INSTALLATA SOLO SUL MODELLO PSE1800

Pos. A REFRIGERANT CONDENSER PLATE VERSION
VERSIONE CONDENSATORE A PIASTRE

Pos. B REFRIGERANT CONDENSER SHELL AND TUBE VERSION
VERSIONE CONDENSATORE FASCIO TUBIERO

(Sheet 1 of 13)

	1	2	3	4	5	6	7	8
A								
B								
C								
D								
E								
F								

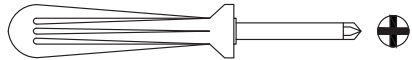
Tightening Torque		
		
Component	Nm	Lb*In
DILM9-10	1,2000	10,6000
DILM25-10	3,2000	28,3000
DILM32-10	3,2000	28,3000
DILM40-10	3,2000	28,3000
PKZM0-16	1,7000	15,0000
PKZM0-25	1,7000	15,0000
PKZM0-32	1,7000	15,0000
OT100F3	6,2000	55,0000
BCH	2,5000	22,0000
M4_8SFL	0,8000	7,0000
FV1	0,5000	4,4000

ANSI Symbol	ANSI Code	IEC 617 Symbol	IEC Code	Description
	CON		KM	Contactor contact open
	CON		KM	Contactor contact closed
	CR		KA	Relay contact open
	CR		KA	Relay contact closed
	TR		KT	Timed contact, N.O. - on delay (TDE)
	TR		KT	Timed contact, N.C. - on delay (TDE)
	TR		KT	Timed contact, N.C. - off delay (TDD)
	TR		KT	Timed contact, N.O. - off delay (TDD)
	SS		SA	Selector switch
	PB		SB	Pushbutton N.O.
	PB		SB	Pushbutton N.C.
	PB		SB	Pushbutton mushroom head
	FL		SL	Liquid level switch
	FLS		SF	Flow switch
	PS		SP	Pressure switch
	TS		ST	Temperature switch
	LS		SQ	Limit switch
	PRS		SQ	Proximity switch
	LT		HL	Indicating light
	PL		XS	Plug and socket
	CR		KA	Control relay coil
	CON		KM	Contactor coil
	M		KM	Motor starter coil
	TR		KA	Timer coil
	SOL		YV	Solenoid coil
	CTR		EC	Electromechanical counter
	CB		QF	Circuit breaker
	TI		X1	Terminals (reference)
			XT	Fused terminals (reference)
	FU		FU	Fuse, protective

PLAMINETRIA QUADRO ELETTRICO – ELECTRICAL PANEL LAY OUT

MODELLI / MODEL PSE 1400 - 1600 - 2000

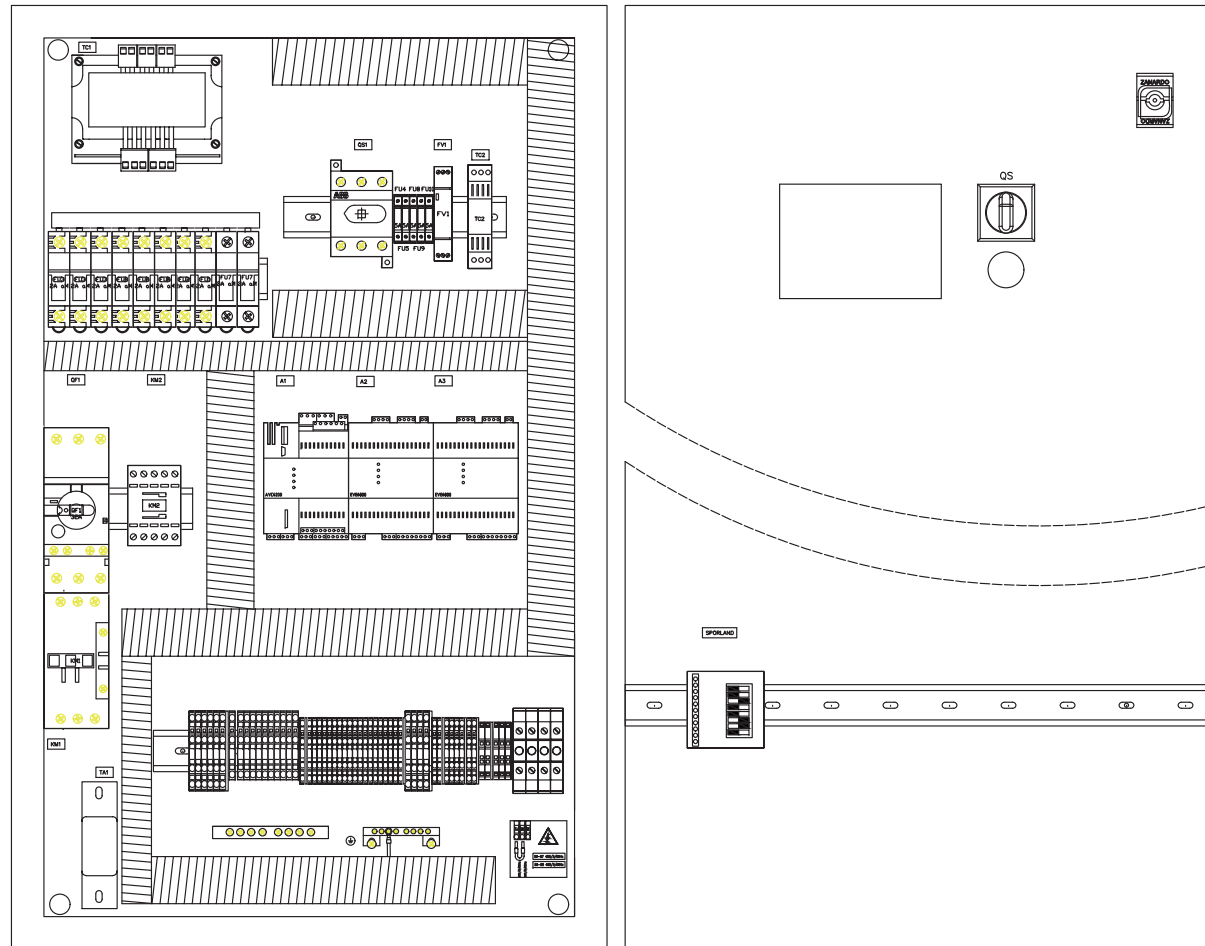

(Sheet 3 of 13)

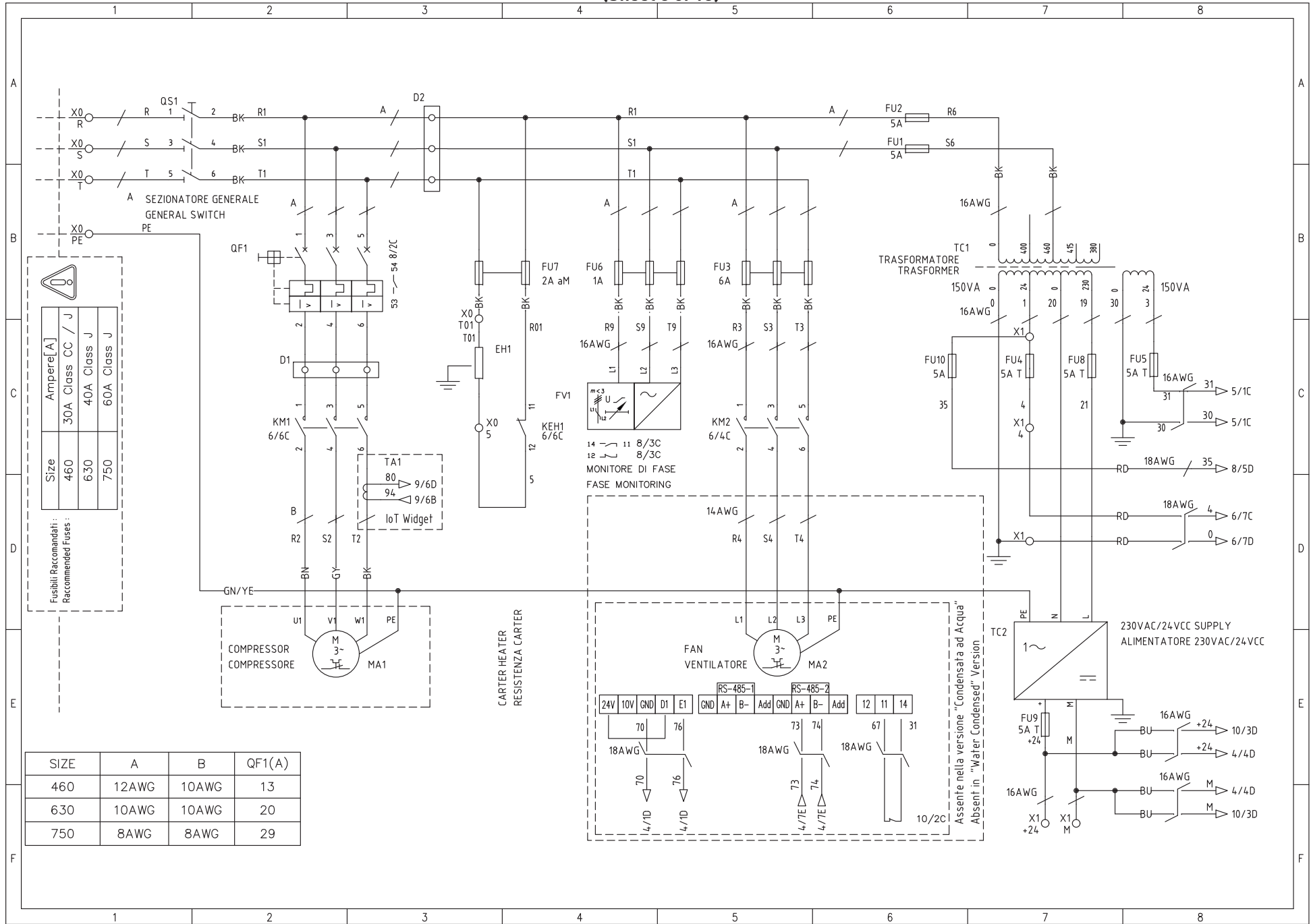

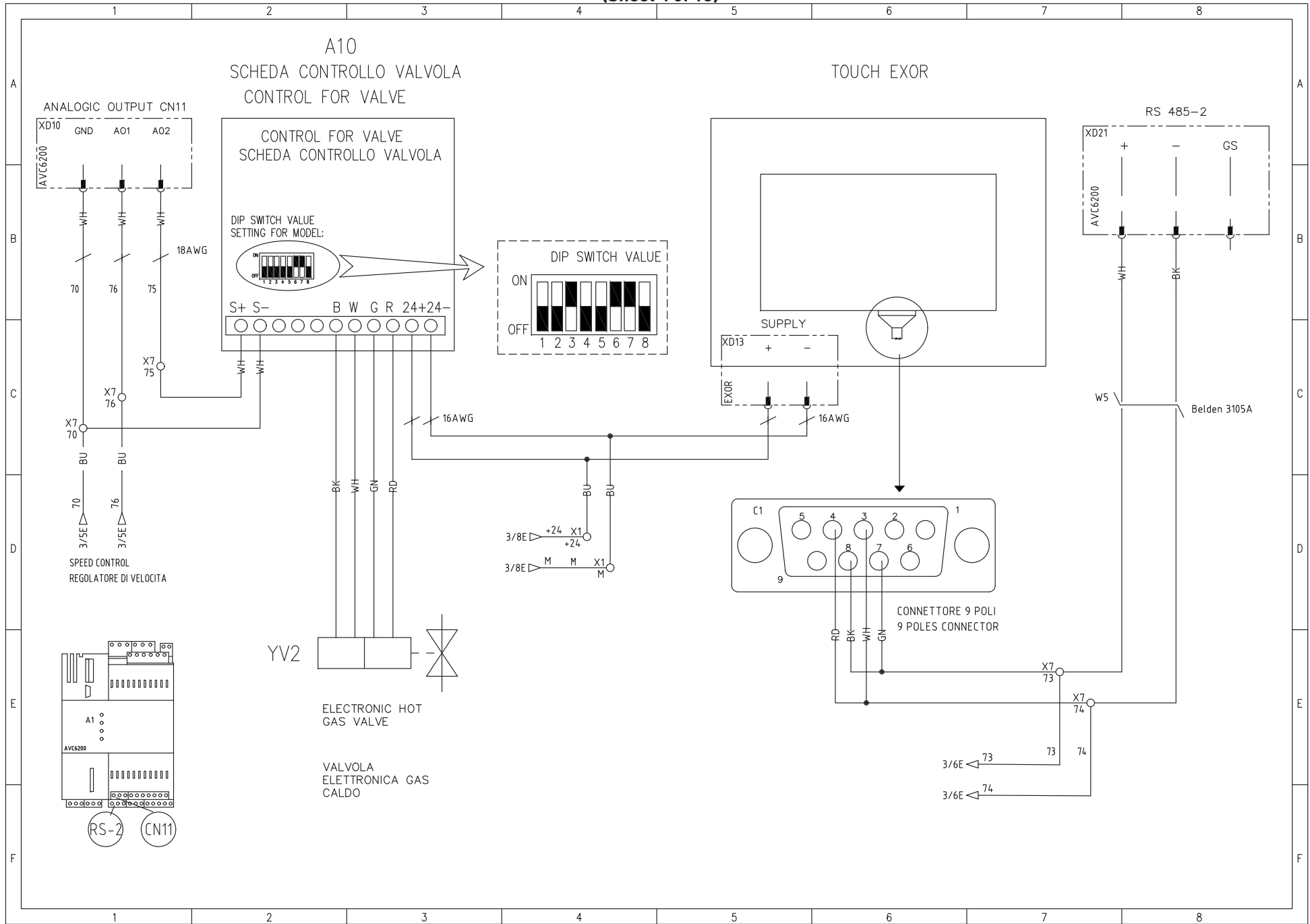

(Sheet 5 of 13)

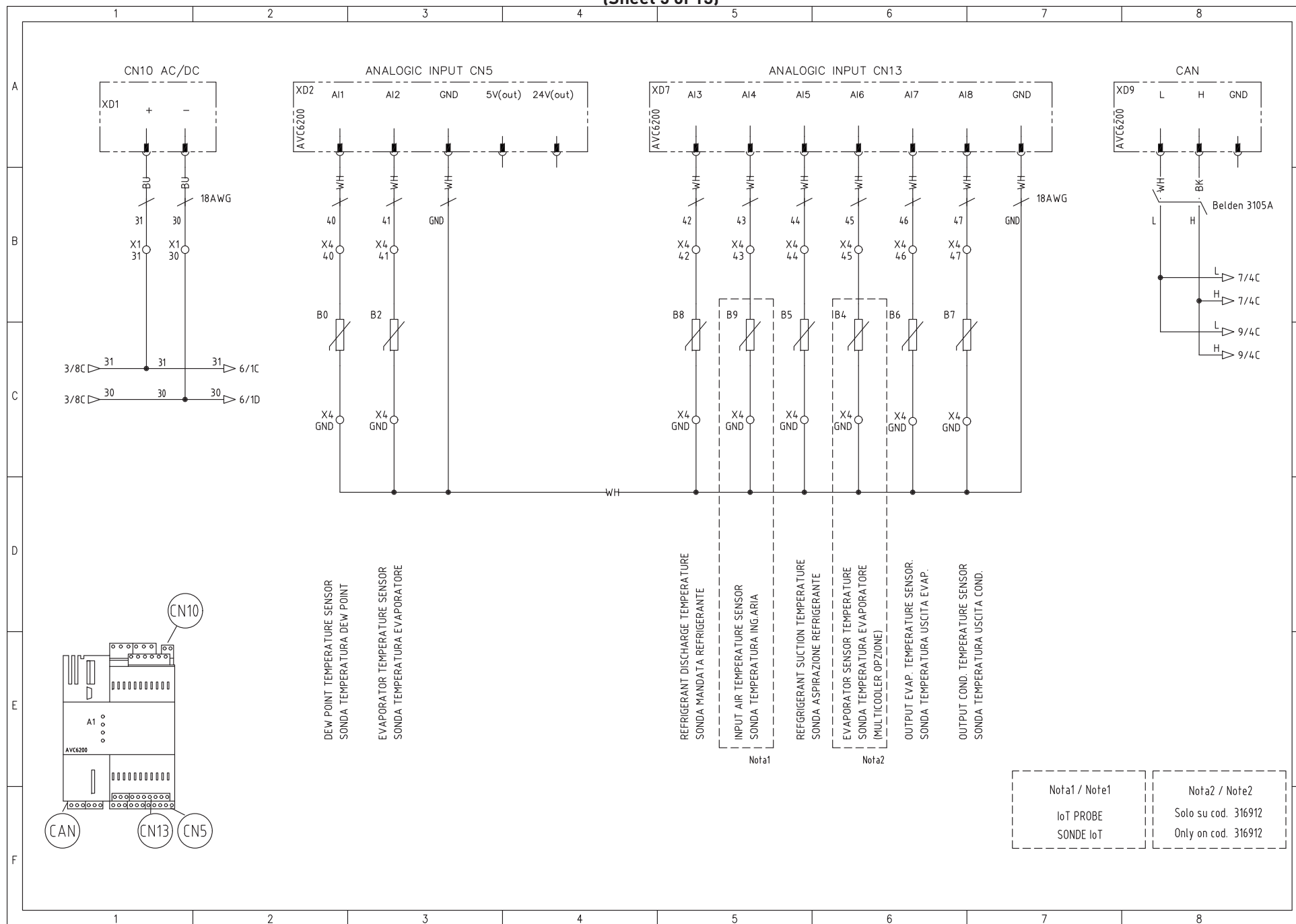

(Sheet 7 of 13)

EVE6000 - EXPANSION 1

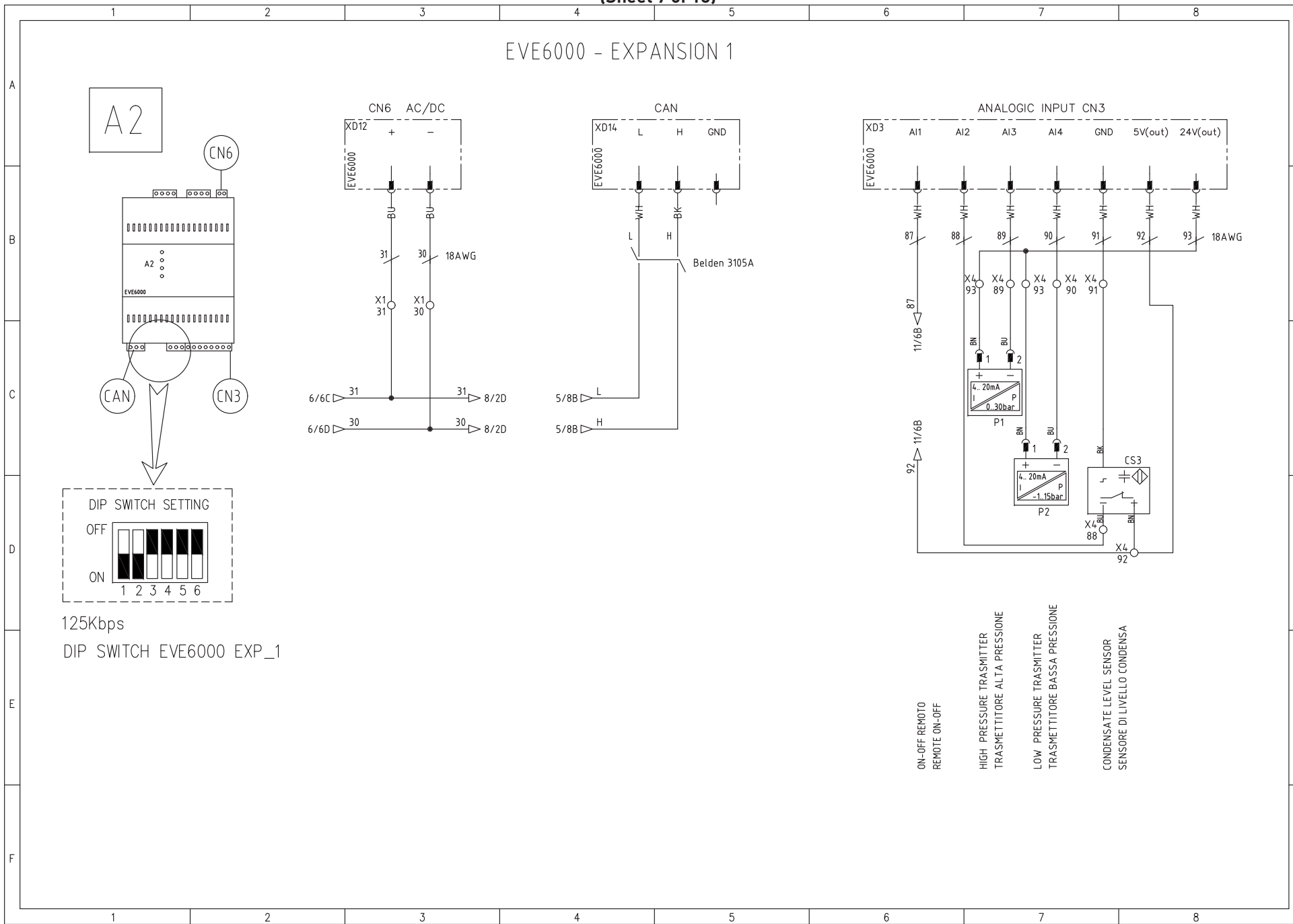

EVE6000 - EXPANSION 1

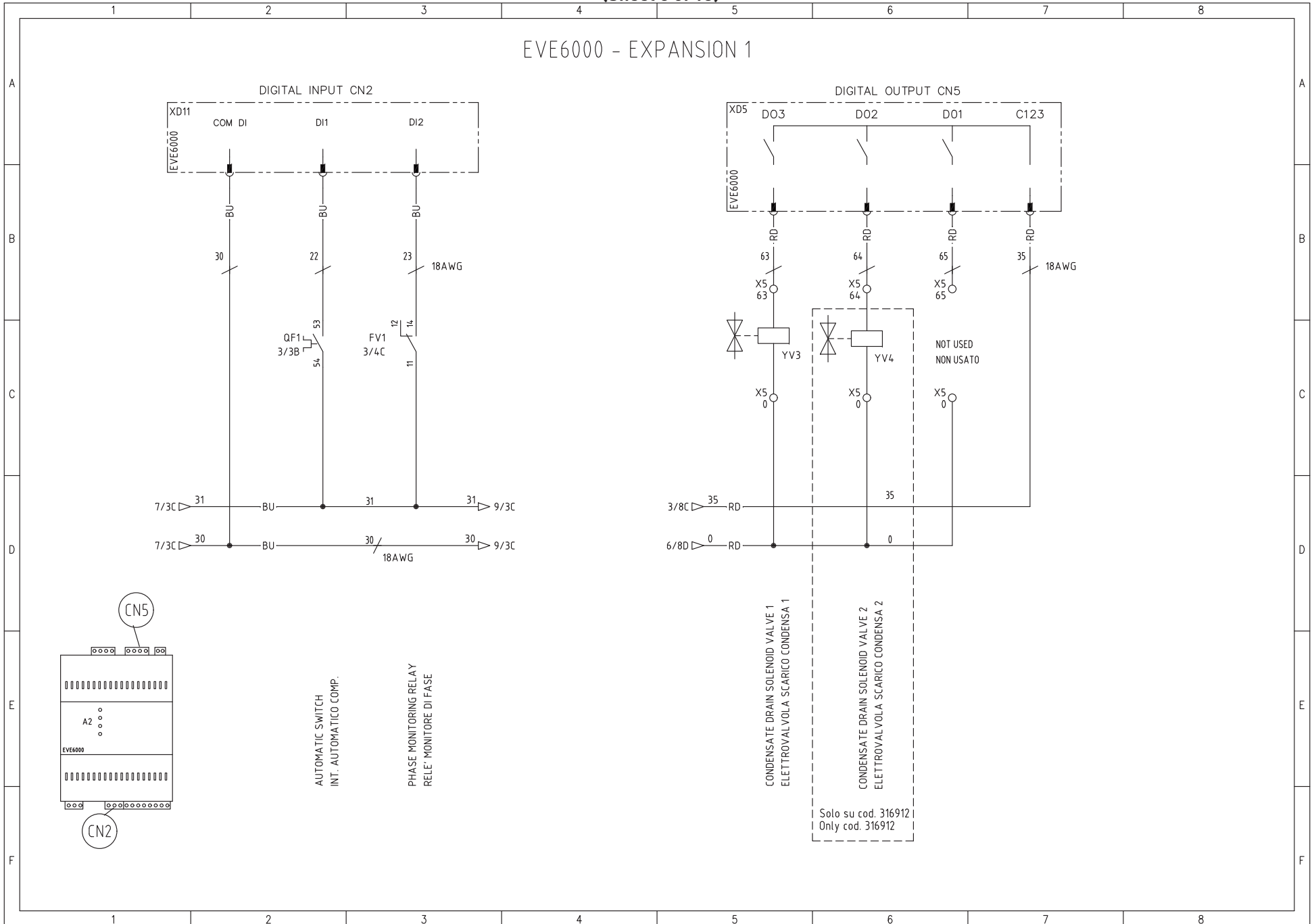

(Sheet 9 of 13)

EVE6000 - EXPANSION 2

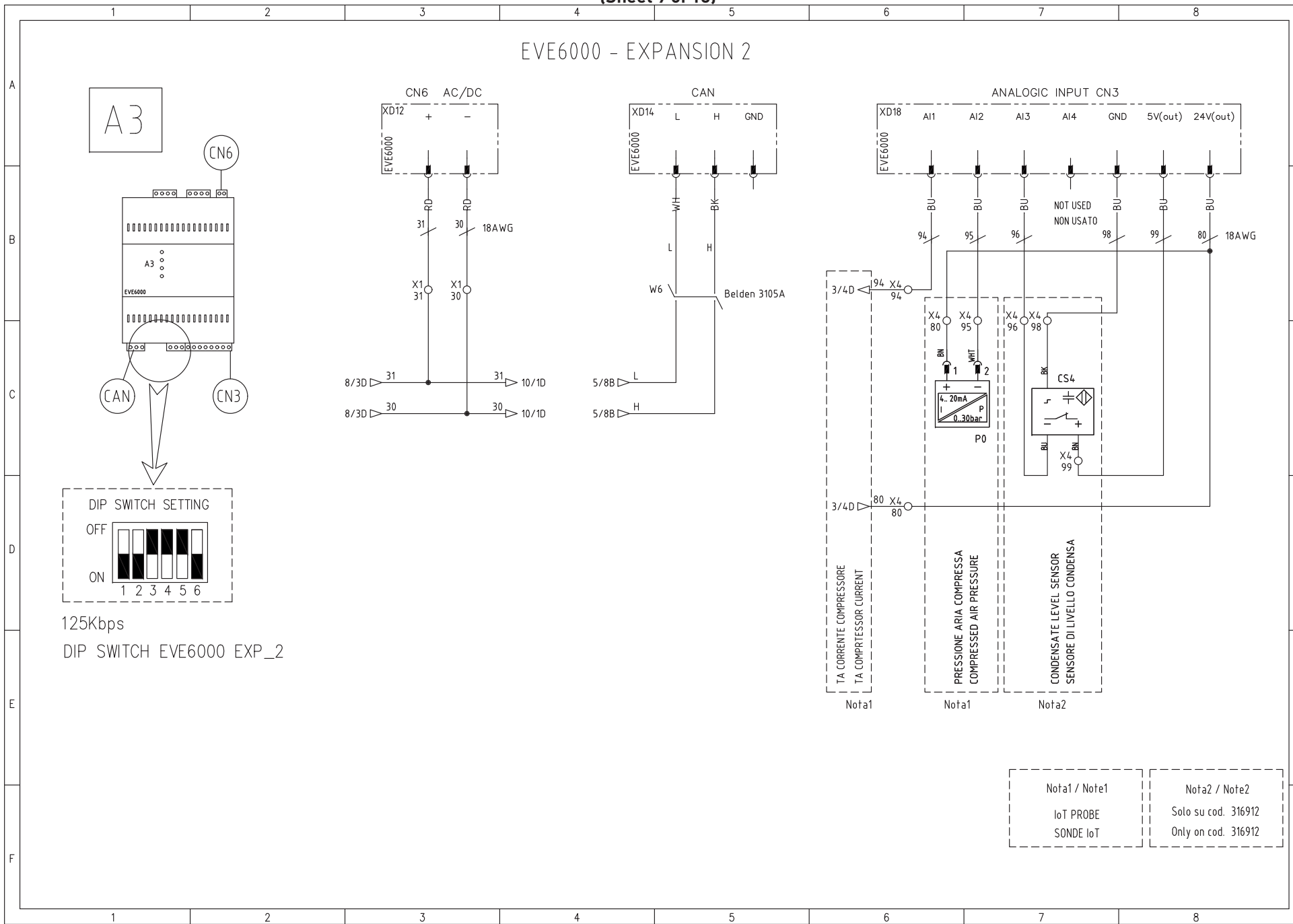

EVE6000 - EXPANSION 2

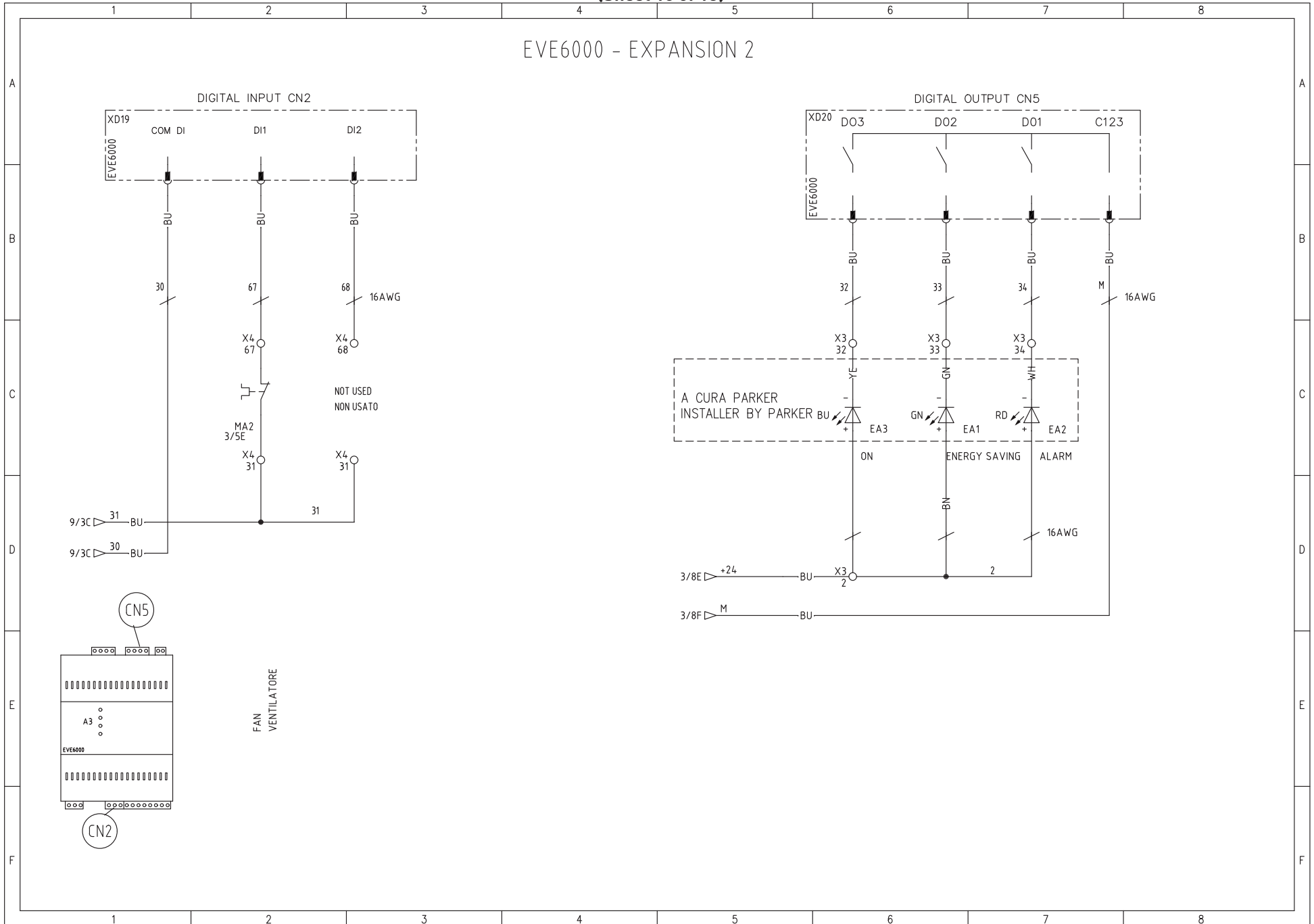

(Sheet 11 of 13)

FREE CONTACTS TERMINAL BLOCKS – MORSETTI COLLEGAMENTI CONTATTI PULITI

STATE MACHINE
STATO MACCHINA

DIGITAL OUTPUT CN4

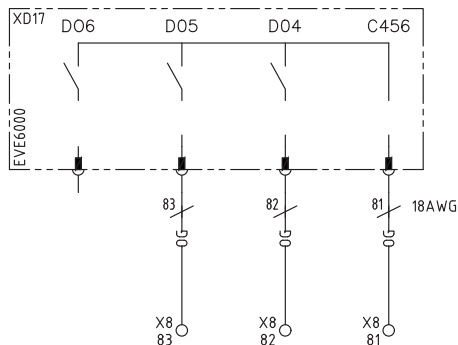

(H)

GENERAL ALARM
ALLARME GENERALE

DIGITAL OUTPUT CN6

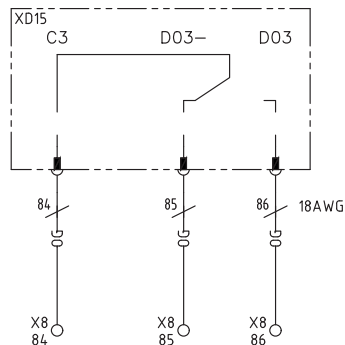

(H)

REMOTE ON/OFF
ON/OFF REMOTO

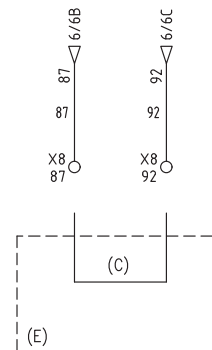

(E)

RS - 485-1-AVC6200

RS 485-AVC6200

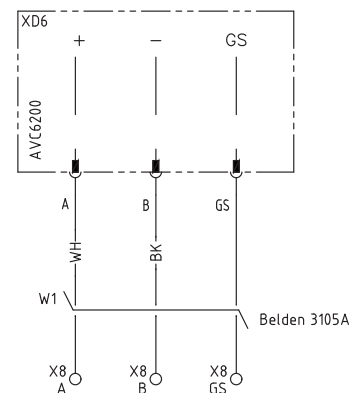

(RX+ / TX+)

(RX- / TX-)

X9
PORTA USB
USB PORT

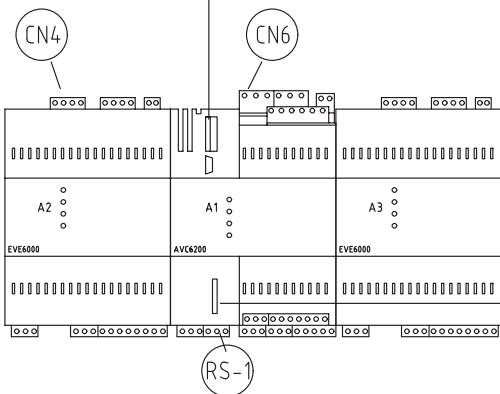

E1
MicroSD
8GB

(H)
I max = 1Amp
250Vac

(C)
Togliere il Ponte se viene installato On/Off Remoto
Remove the bridge if On/Off Remoto is installed

(E)
Collegamento On/Off Remoto
On/Off Remote Supply

Tightening Torque		
		
Component	Nm	Lb*In
DILM9-10	1,2000	10,6000
DILM65-10	3,3000	29,0000
DILM72-10	1,2000	10,6000
PKZM4-40	3,3000	29,0000
PKZM4-58	3,3000	29,0000
OT100F3	6,2000	55,0000
BCH	2,5000	22,0000
M4_8SFL	0,8000	7,0000

ANSI Symbol	ANSI Code	IEC 617 Symbol	IEC Code	Description
	CON		KM	Contactor contact open
	CON		KM	Contactor contact closed
	CR		KA	Relay contact open
	CR		KA	Relay contact closed
	TR		KT	Timed contact, N.O. - on delay (TDE)
	TR		KT	Timed contact, N.C. - on delay (TDE)
	TR		KT	Timed contact, N.C. - off delay (TDD)
	TR		KT	Timed contact, N.O. - off delay (TDD)
	SS		SA	Selector switch
	PB		SB	Pushbutton N.O.
	PB		SB	Pushbutton N.C.
	PB		SB	Pushbutton mushroom head
	FL		SL	Liquid level switch
	FLS		SF	Flow switch
	PS		SP	Pressure switch
	TS		ST	Temperature switch
	LS		SO	Limit switch
	PRS		SO	Proximity switch
	LT		HL	Indicating light
	PL		XS	Plug and socket
	CR		KA	Control relay coil
	CON		KM	Contactor coil
	M		KM	Motor starter coil
	TR		KA	Timer coil
	SOL		YV	Solenoid coil
	CTR		EC	Electromechanical counter
	CB		OF	Circuit breaker
	T1		X1	Terminals (reference)
			XT	Fused terminals (reference)
	FU		FU	Fuse, protective

(Sheet 2 of 12)

PLAMINETRIA QUADRO ELETTRICO – ELECTRICAL PANEL LAY OUT

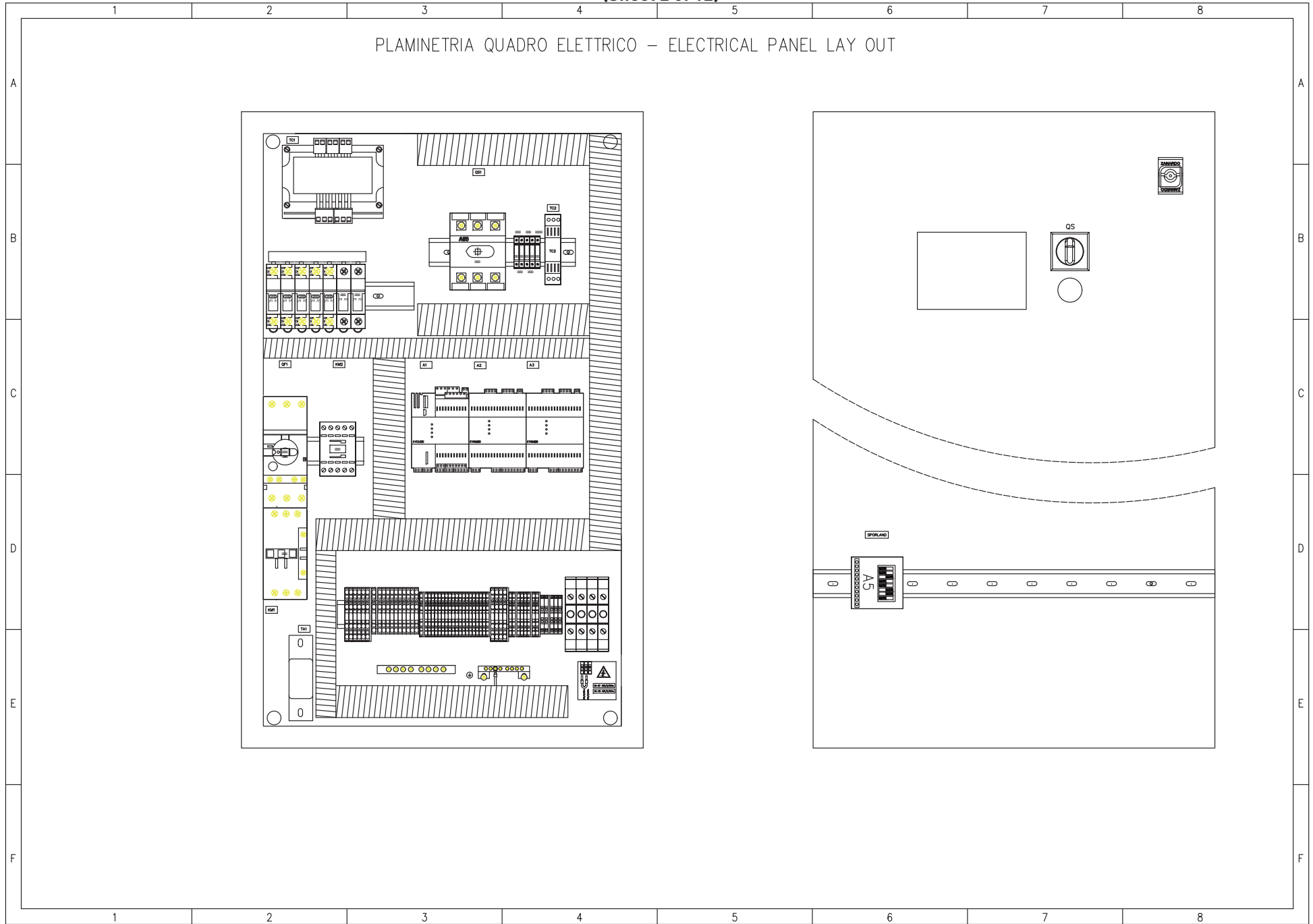

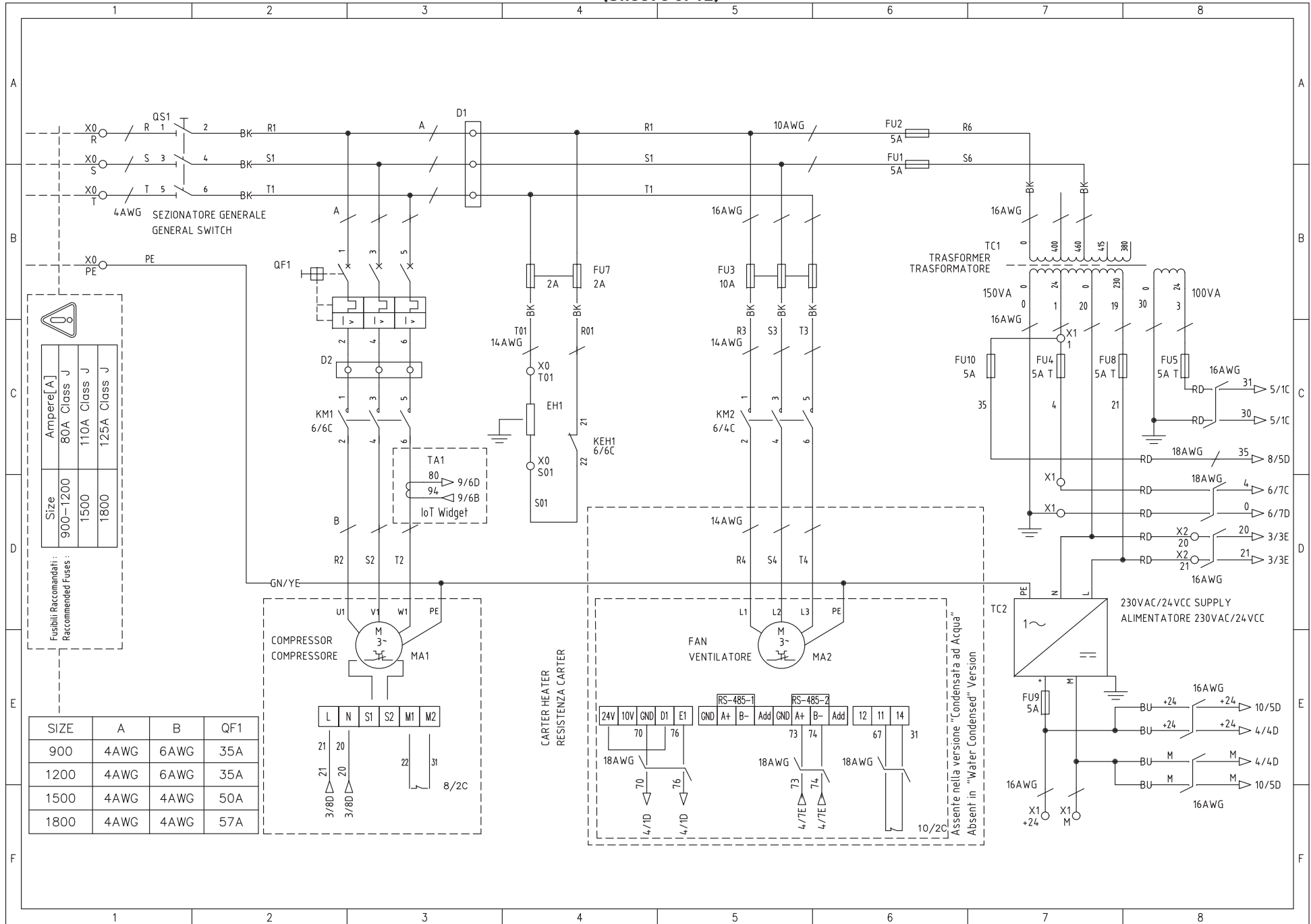

(Sheet 4 of 12)

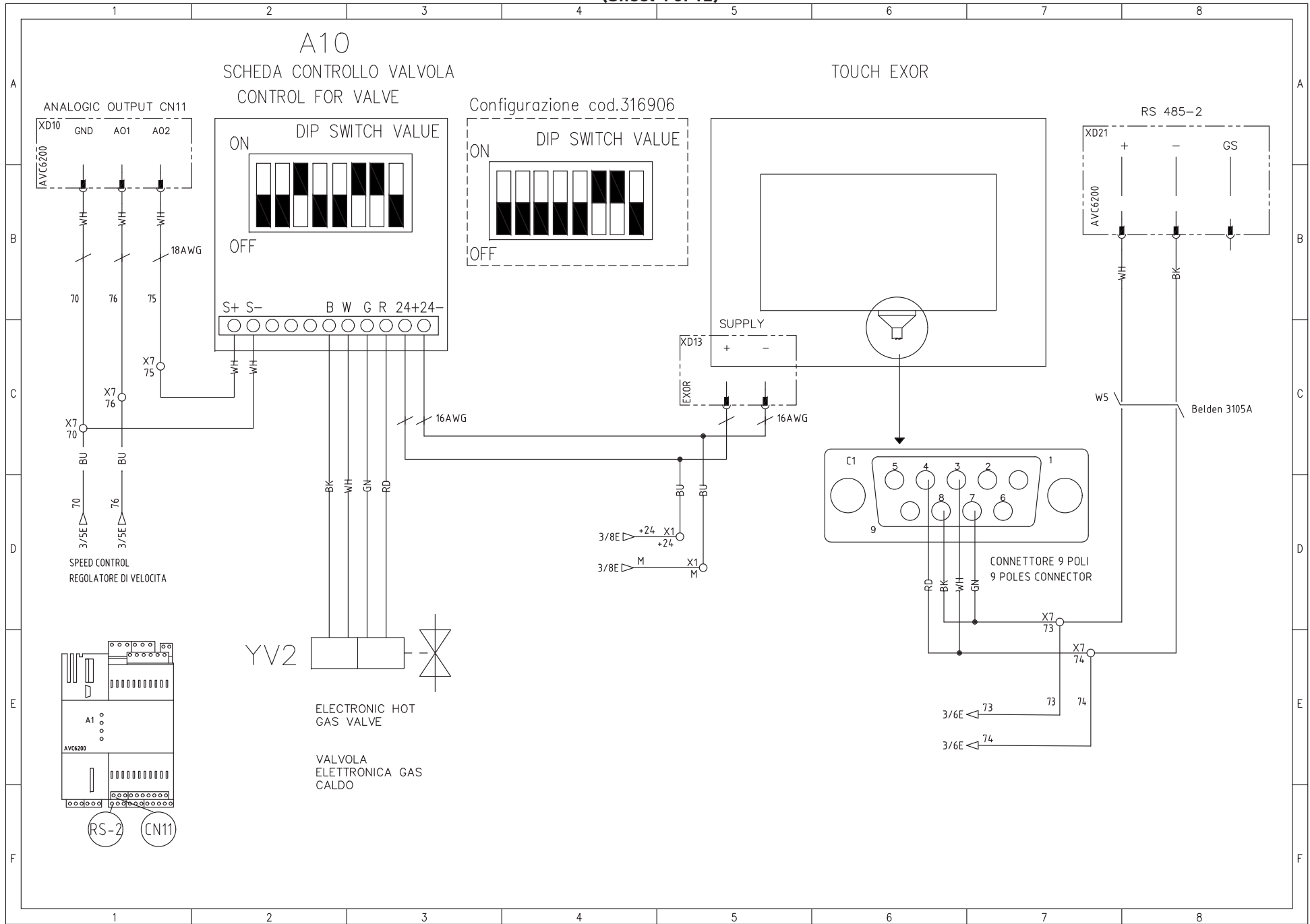

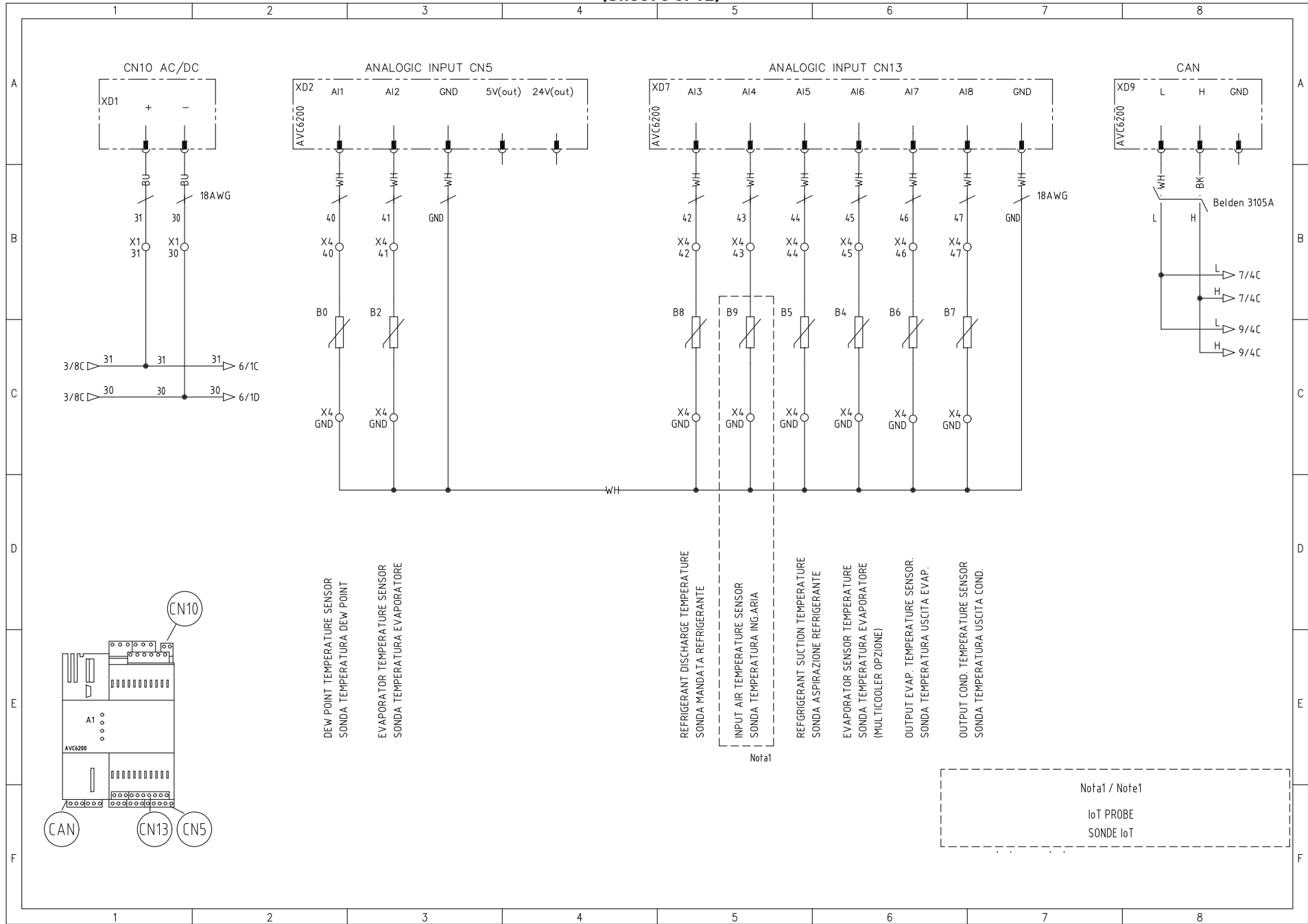

(Sheet 6 of 12)

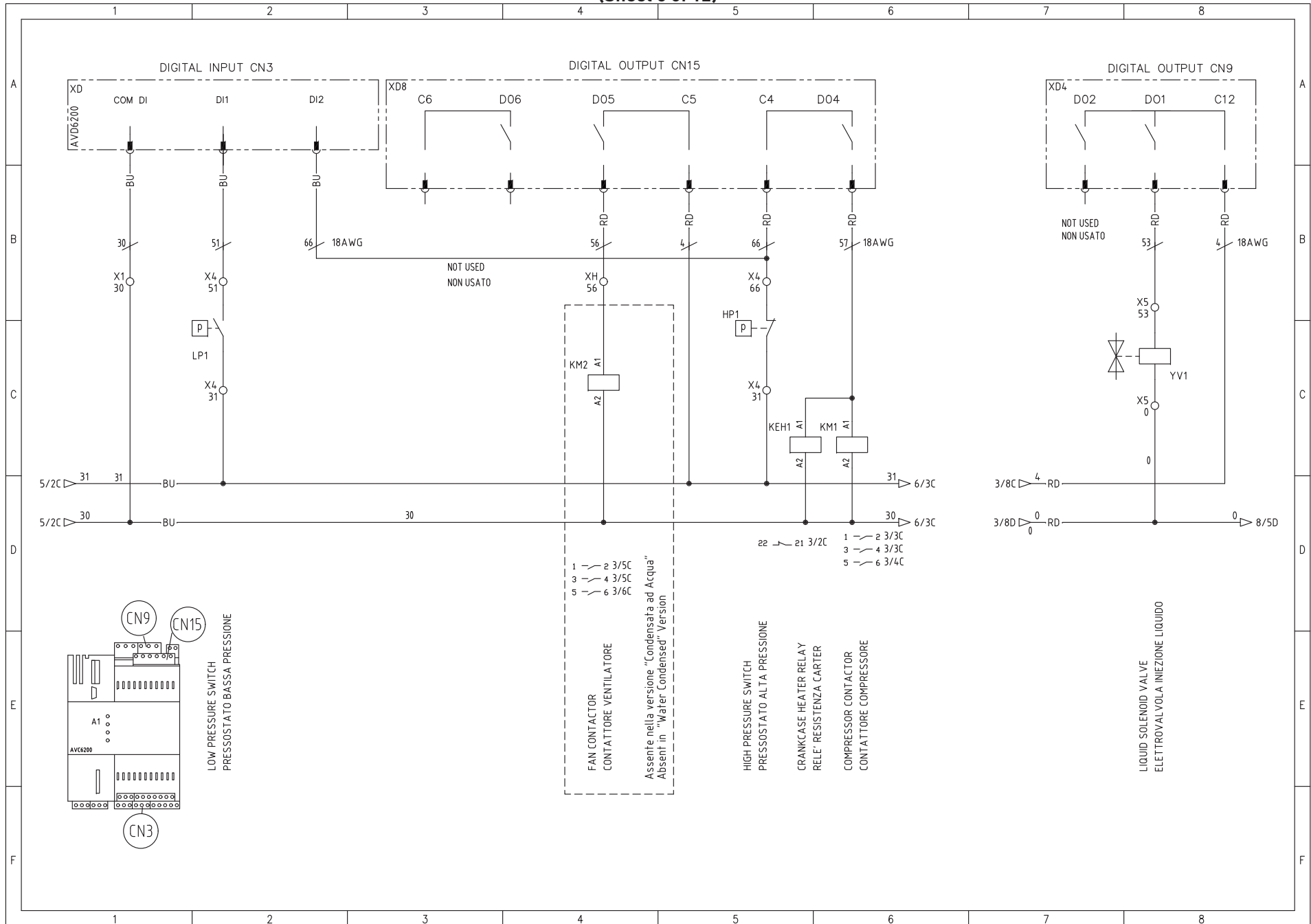

EVE6000 - EXPANSION 1

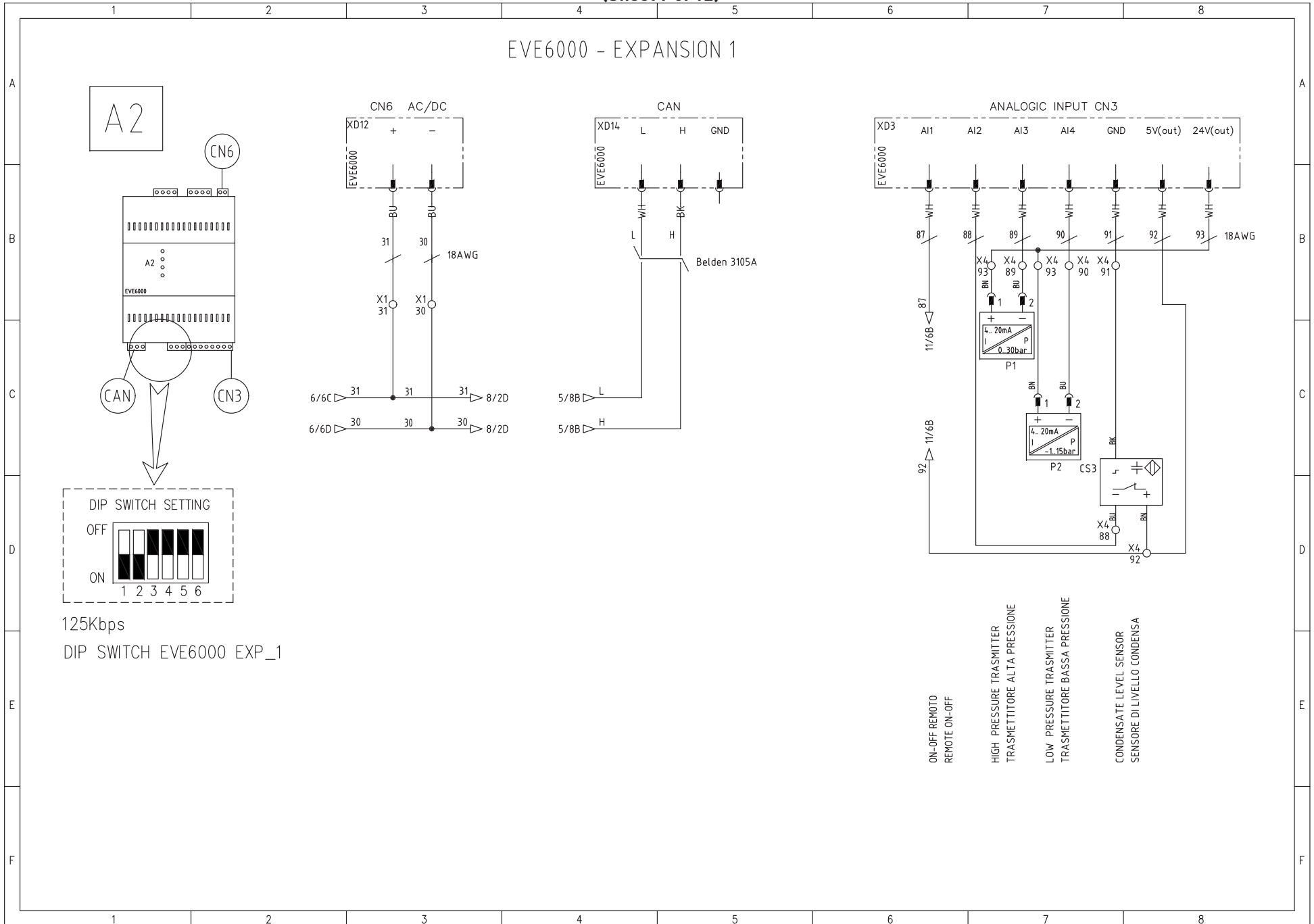

(Sheet 8 of 12)

EVE6000 - EXPANSION 1

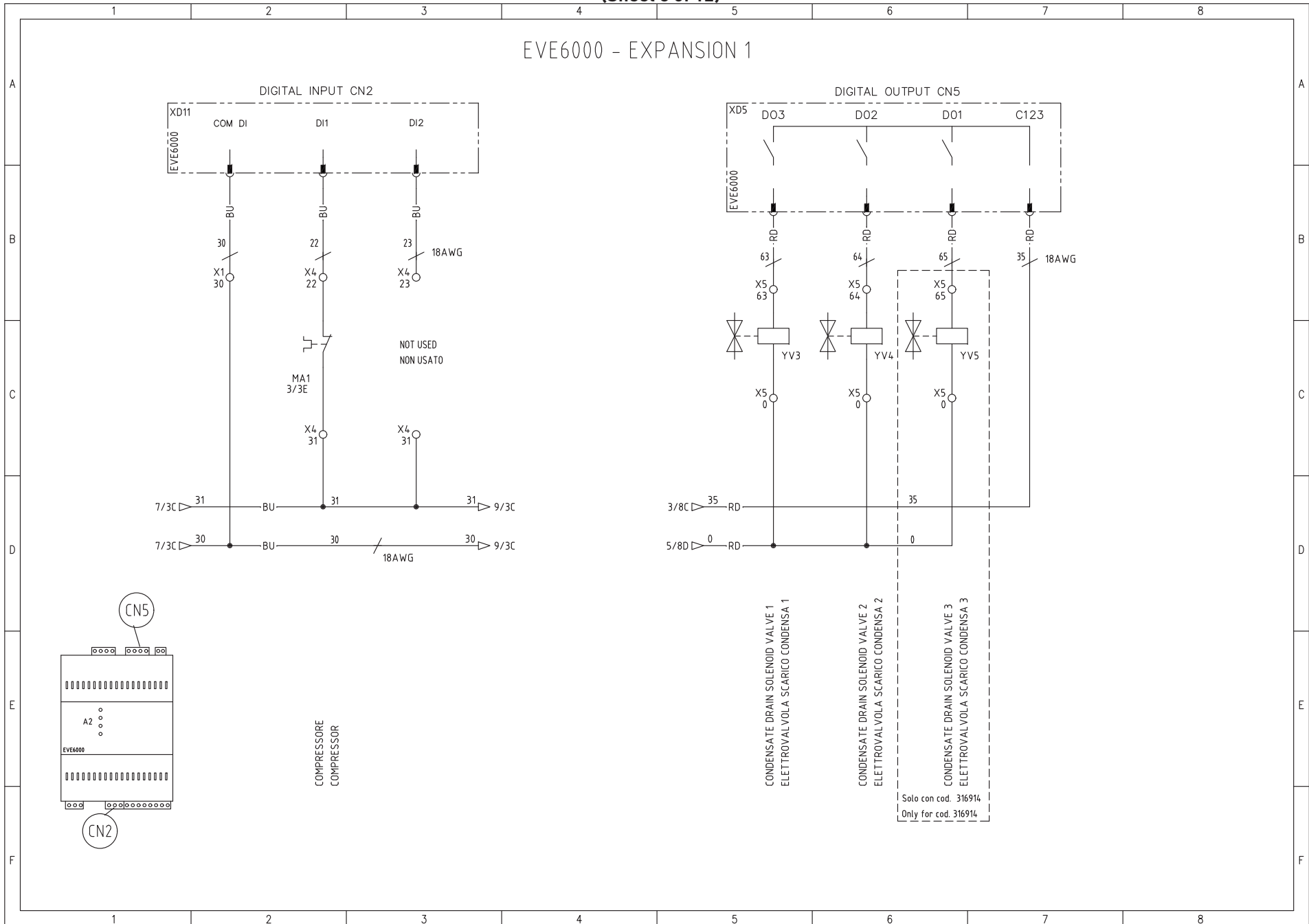

EVE6000 - EXPANSION 2

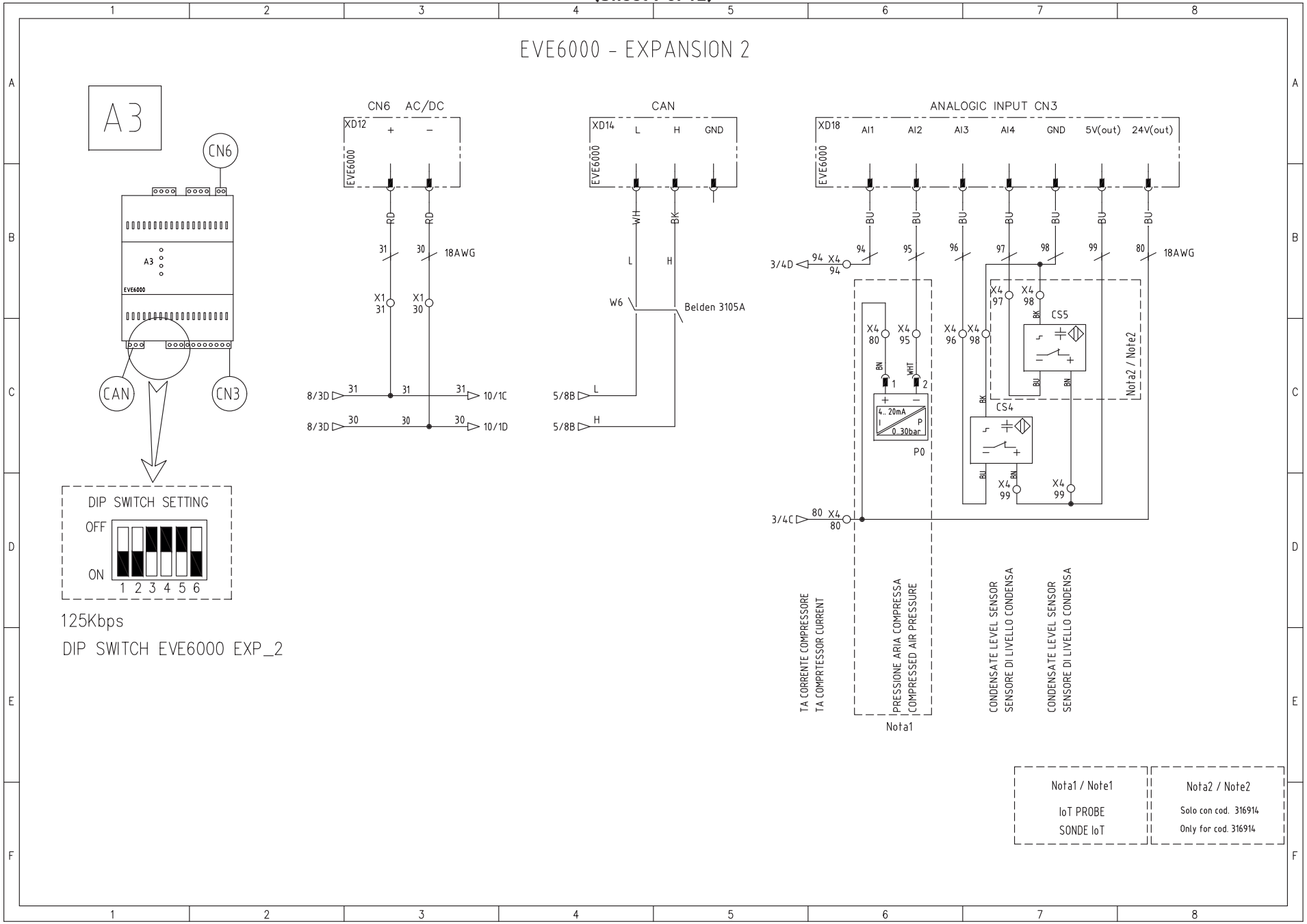

(Sheet 10 of 12)

EVE6000 - EXPANSION 2

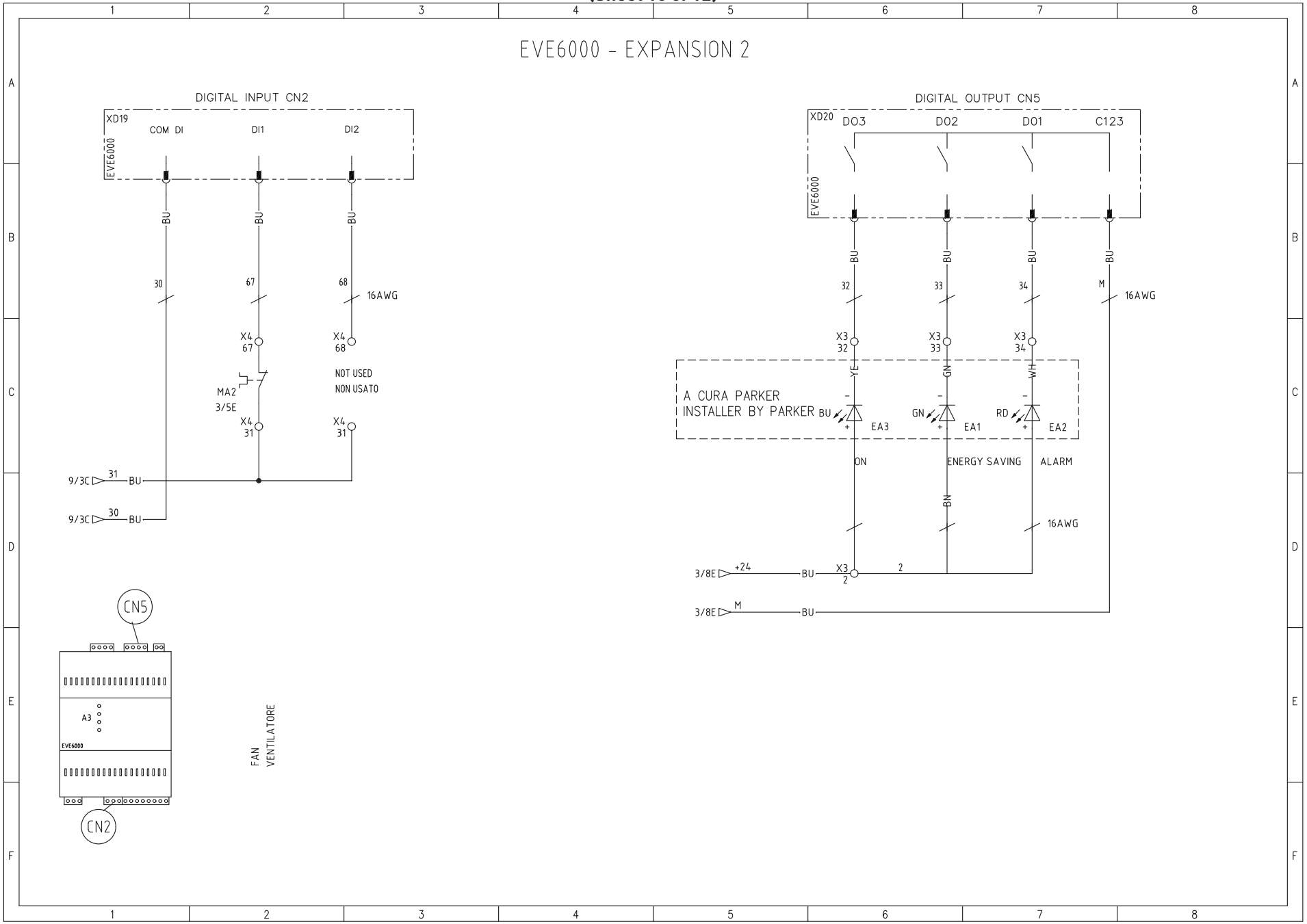

FREE CONTACTS TERMINAL BLOCKS – MORSETTI COLLEGAMENTI CONTATTI PULITI

STATE MACHINE
STATO MACCHINA

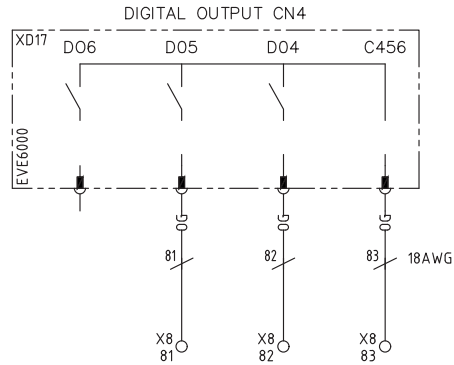

(H)

GENERAL ALARM
ALLARME GENERALE

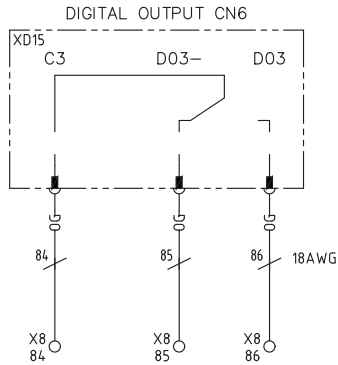

(H)

REMOTE ON/OFF
ON/OFF REMOTO

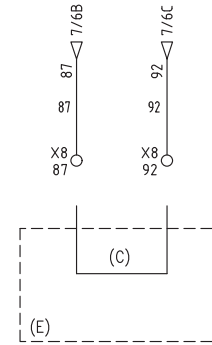

RS - 485-1-AVC6200

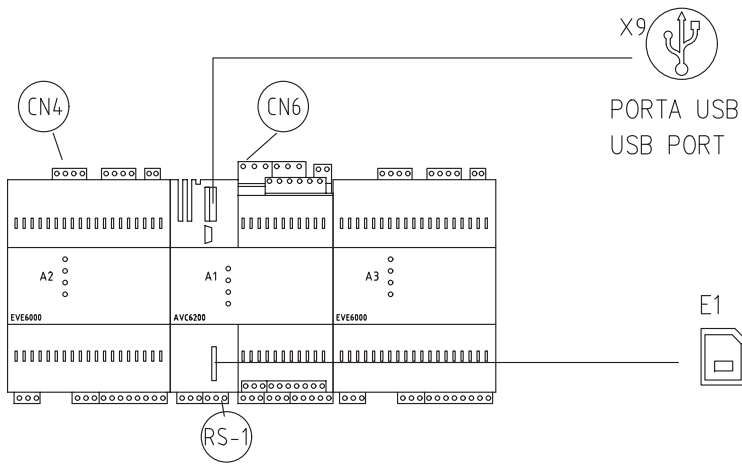
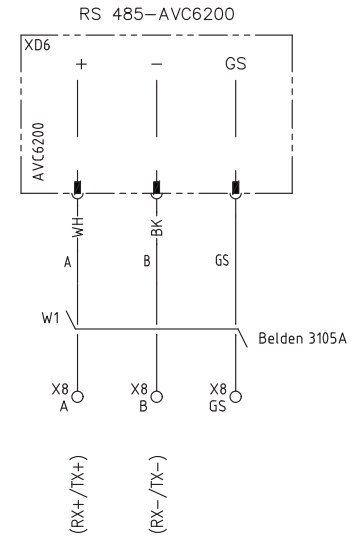

- (H) I max = 1Amp
250Vac
- (C) Togliere il Ponte se viene installato On/Off Remoto
Remove the bridge if On/Off Remote is installed
- (E) Collegamento On/Off Remoto
On/Off Remote Supply

(Sheet 12 of 12)

TERMINAL BLOCKS-MORSETTIERA 2400-6000 A-W Cod.316913/14

Terminal Block	X3	X5	X7	X4	X2	X1	XH	X8	X0
Terminal	32	2		94	21	24	56	GS	S01
1 level	32	2		95	21	24	56	B	T01
link	33	33		96	20	M		A	T
2 level	0	65		97	20	M			S
link	0	64		98	20	M			R
wire down	0	63		99	20	4			R
wire up	0	53		99	21	0			PE

stripled
 stripped
 condensate drain valve
 condensate drain valve
 condensate drain valve
 liquid valve
 fan speed
 HGBV-E
 Modbus -
 Modbus +
 spare
 fan alarm
 spare
 Cmp alarm
 compressor TA
 air pressure transmitter
 low pressure transmitter
 high pressure transmitter
 5V
 5V
 capacitive sensor CS5
 capacitive sensor CS4
 5V
 capacitive sensor CS3
 high pressure switch
 low pressure switch
 out condensor probe B7
 out evaporator probe B6
 ambient temperature B3
 suction probe B5
 air compressed probe B9
 discharge probe B8
 evaporator probe B2
 dew point probe B0
 Cmp_Control
 aux. 24Vac
 aux. 24Vac
 aux. 24Vac
 aux. 24Vac
 aux. 24Vac
 aux. 24Vac
 control supply 24Vac
 control supply 24Vac
 control supply 24Vac
 control supply 24Vac
 fan protection motor
 modbus RTU - RS485
 modbus RTU - RS485
 modbus RTU - RS485
 plant status/ general alarm
 plant status/ general alarm
 plant status/ general alarm
 remote ON/OFF
 crankcase heater
 crankcase heater
 power supply
 power supply
 power supply
 supply terminal PE

C	Aggiornamento Generale	04/08/21	V.Dante	DATE	09/02/21	 Manufactured by Parker - Ham/Fin Manufacturing S.r.l. Gas Separation and Filtration Division EMEA Strada Zona Industriale,4 - S. Angelo di Piove (PD) Italy HI ROSS is a registered trademark owned by United HROSS S.p.A.	Terminal Blocks Morsettiera 460V/3/60Hz	destination - destinazione PSE	Rev. C	Sheet 12 of 18
B	Second Issue	16/03/21	V.Dante	DRAFT	V.Dante		drawing - disegno H39AB1800E006			
A	First Issue	09/02/21	V.Dante	CHECK	G.Maniero					
REV.	DESCRIPTION	DATE	SIGN.	APPR.	M.Polenta					

THIS DOCUMENT CONTAINS INFORMATION THAT IS CONFIDENTIAL AND PROPRIETARY TO PARKER HANNIFIN MANUFACTURING S.R.L. THIS DOCUMENT IS FURNISHED ON THE UNDERSTANDING THAT THE DOCUMENT AND THE INFORMATION IT CONTAINS WILL NOT BE COPIED OR DISCLOSED TO OTHERS OR USED FOR ANY PURPOSE OTHER THAN CONDUCTING BUSINESS WITH PARKER, AND WILL BE RETURNED AND ALL FURTHER USE DISCONTINUED UPON REQUEST BY PARKER. THE RECIPIENT OF THIS DOCUMENT THROUGH ITS OWN ANALYSIS AND TESTING IS SOLELY RESPONSIBLE FOR MAKING THE FINAL SELECTION OF THE APPLICABLE SYSTEM AND COMPONENTS AND ASSURING THAT ALL PERFORMANCE, ENDURANCE, MAINTENANCE, SAFETY AND WARNING REQUIREMENTS OF THE APPLICATION ARE MET. COPYRIGHT PARKER. YEAR OF COPYRIGHT IS FIRST YEAR INDICATED ON THIS DOCUMENT. ALL RIGHTS RESERVED.



A division of Parker Hannifin Corporation

Parker Hannifin Corporation

Industrial Gas Filtration and Generation Division

4087 Walden Avenue

Lancaster, NY 14086

Tel: + 1 800 343 4048

Web site: www.parker.com/igfg

E-mail: gsfsupport@parker.com

Parker Hannifin Manufacturing S.r.l.

Sede Legale:

Via Sebastiano Caboto 1, Palazzina "A" 20094 Corsico (MI) Italy

Sede Operativa:

Gas Separation and Filtration Division EMEA - Strada Zona Industriale, 4

35020 S. Angelo di Piove (PD) Italy

tel +39 049 971 2111- fax +39 049 9701911

Web-site: www.parker.com