



Kaishan Compressor USA

Instructions for installation and operation

Compressed air refrigeration dryer

DRS30-DRS125

EN - English

Dear customer,

Thank you for deciding in favour of the DRS30-DRS125 compressed-air refrigeration dryer. Please read these installation and operating instructions carefully before mounting and starting up the DRS30-DRS125 and follow our directions. Perfect functioning of the DRS30-DRS125 and thus reliable compressed-air drying can only be guaranteed when the provisions and notes stipulated here are strictly adhered to.



Control Nr. 4009404
Conforms to ANSI/UL Std. 1995
Cert. to CSA-C22.2 No.236

Contents

1	Name plate	5
2	Safety instructions	5
2.1	Safety pictograms in accordance with DIN 4844	6
2.2	Signal words in accordance with ANSI	8
2.3	Overview of the safety instructions	8
3	Proper use	10
4	Exclusion from a field of application	11
5	Operating instructions in accordance with the 2014/68/EU Pressure Equipment Directive	11
6	Transport	11
7	Storage	12
8	Installation	12
8.1	Place of installation	12
8.2	Installation plan	13
8.3	Correction factors	14
8.4	Connection to the compressed-air system	15
8.5	Electrical connections	15
8.6	Condensate drain	16
9	Start-up	16
9.1	Preliminary stages	16
9.2	Initial start-up	17
9.3	Shut down and restart	18
10	Technical data	19
11	Technical description	20
11.1	Control panel	20
11.2	Functional description	20
11.3	Flow chart	21
11.4	Refrigerating compressor	22
11.5	Condenser	22
11.6	Filter dryer	22
11.7	Capillary tube	22
11.8	Aluminium heat exchanger	22
11.9	Hot-gas bypass valve	22
11.10	Electronic instrument DMC35	23
11.10.1	How to switch on the dryer	23
11.10.2	How to switch off the dryer	23
11.10.3	How a service warning / alarm is displayed	23
11.10.4	How is controlled the condenser fan	24
11.10.5	How is controlled the drain solenoid valve	24
11.10.6	How to display the total hours of operation	24
11.10.7	How to change the operating parameters – SETUP menu	24
12	Maintenance, troubleshooting, spare parts and dismantling	25
12.1	Checks and maintenance	25
12.2	Troubleshooting	26
12.3	Recommended spare parts	29
12.4	Maintenance works at the refrigeration cycle	30
12.5	Dismantling the dryer	30
13	Appendices	31
13.1	Dryer dimensions DRS 30-40	31
13.2	Dryer dimensions DRS 60-80	32
13.3	Dryer dimensions DRS 100	33
13.4	Dryer dimensions DRS 125	34
13.5	Exploded diagrams	35
13.5.1	Components of the exploded diagrams	35
13.5.2	Exploded diagram DRS 30-80	36
13.5.3	Exploded diagram DRS 100	37
13.5.4	Exploded diagram DRS 125	38

13.6	Electric diagrams	39
13.6.1	Electric diagrams – list of components	39
13.6.2	Electric diagram DRS 30-100	40
13.6.3	Electric diagram DRS 125	41

1 Name plate

The name plate is on the back of the dryer and comprises all primary data of the device. Always refer to these when contacting the manufacturer or the sales department.

All guarantee claims will expire in the event that the name plate is modified or removed.

2 Safety instructions



Please check whether or not these instructions correspond to the device type.

Please adhere to all advice given in these operating instructions. They include essential information which must be observed during installation, operation and maintenance. Therefore, it must be ensured that these operating instructions are read by the fitter and the responsible operator / certified skilled personnel prior to installation, start-up and maintenance.

The operating instructions must be accessible at all times at the place of application of the DRS30-DRS125 compressed-air refrigeration dryer.

In addition to these operating instructions, local and national regulations need to be observed, where required .

Ensure that operation of the DRS30-DRS125 compressed-air refrigeration dryer only takes place within the permissible limit values indicated on the name plate. Any deviation from these limit values involves a risk for persons and for the material, and may result in malfunction or a breakdown.

After installing the device correctly and in accordance with the instructions in this manual, the dryer is ready to operate, further settings are not required. Operation is fully automatic and maintenance is limited to several examinations and cleaning measures which are described in the following chapters.

This manual must be available at all times for future reference and is a constituent part of the dryer.

If you have any queries regarding these installation and operating instructions, please contact Kaishan Compressor USA.

Safety instructions

2.1 Safety pictograms in accordance with DIN 4844



Observe operating instructions



General danger symbol



Supply voltage



Danger: component or system under pressure



Hot surfaces



Non-breathable air



Do not use water to extinguish the fire



Do not operate with open cover (housing)



Maintenance works or controlling measures must only be carried out by qualified personnel¹



Do not smoke



Note



Connection point compressed-air inlet



Connection point compressed-air outlet



Connection point condensate drain



Works can be carried out by the operator of the plant, provided that they are skilled accordingly².

¹ Certified skilled personnel are persons who are authorised by the manufacturer, with experience and technical training, who are well-grounded in the respective provisions and laws and capable of carrying out the required works and of identifying and avoiding any risks during the machine transport, installation, operation and maintenance. Qualified and authorised operators are persons who are instructed by the manufacturer regarding the handling of the refrigeration system, with experience and technical training, and who are well-grounded in the respective provisions and laws.

² Certified skilled personnel are persons who are authorised by the manufacturer, with experience and technical training, who are well-grounded in the respective provisions and laws and capable of carrying out the required works and of identifying and avoiding any risks during the machine transport, installation, operation and maintenance. Qualified and authorised operators are persons who are instructed by the manufacturer regarding the handling of the refrigeration system, with experience and technical training, and who are well-grounded in the respective provisions and laws.

NOTE: Text that contains important specifications to be considered – does not refer to safety precautions.



The device was carefully designed with particular attention paid to environmental protection:

- CFC-free refrigerants
- CFC-free insulation material
- Energy-saving design
- Limited acoustic emissions
- Dryer and packaging comprise reusable materials

This symbol advises the user to observe the environmental aspects and comply with the recommendations connected with this symbol.

2.2 Signal words in accordance with ANSI

Danger!	Imminent hazard Consequences of non-observance: serious injury or death
Warning!	Potential hazard Consequences of non-observance: possible serious injury or death
Caution!	Imminent hazard Consequences of non-observance: possible injury or property damage
Notice!	Potential hazard Consequences of non-observance: possible injury or property damage
Important!	Additional advice, info, hints Consequences of non-observance: disadvantages during operation and maintenance, no danger

2.3 Overview of the safety instructions



Certified skilled personnel

Installation works must exclusively be carried out by authorised and qualified skilled personnel. Prior to undertaking any measures on the DRS30-DRS125 compressed-air refrigeration dryer, the certified skilled personnel shall read up on the device by carefully studying the operating instructions. The operator is responsible for the adherence to these provisions. The respective directives in force apply to the qualification and expertise of the certified skilled personnel.

For safe operation, the device must only be installed and operated in accordance with the indications in the operating instructions. In addition, the national and operational statutory provisions and safety regulations, as well as the accident prevention regulations required for the respective case of application, need to be observed during employment. This applies accordingly when accessories are used.



Danger!

Compressed air!

Risk of serious injury or death through contact with quickly or suddenly escaping compressed air or through bursting and/or unsecured plant components.

Compressed air is a highly dangerous energy source.

Never work on the dryer when the system is under pressure.

Never direct the compressed-air outlet or condensate drain hoses at persons.

The user is responsible for the proper installation of the dryer. Non-observance of the instructions in the "Installation" chapter leads to the expiration of the guarantee. Improper installation may result in dangerous situations for the personnel and/or the device.



Danger!

Supply voltage!

Contact with non-insulated parts carrying supply voltage involves the risk of an electric shock resulting in injuries and death.

Only qualified and skilled personnel are authorised to run electrically-operated devices. Prior to undertaking maintenance measures at the device, the following requirements must be met:

Make sure that the power supply is switched off and that the device is off and marked for maintenance measures. Please also ensure that the power supply cannot be re-established during the works.

**Caution!****Refrigerant!**

The compressed-air refrigeration dryer uses HFC-containing refrigerants as a coolant.

Please observe the corresponding paragraph entitled "Maintenance works at the refrigeration cycle".

**Warning!****Refrigerant leak!**

A refrigerant leak involves the danger of serious injury and damage to the environment.



The DRS30-DRS125 compressed-air refrigeration dryer contains fluorinated greenhouse gas/refrigerant. Installation, repair and maintenance works at the refrigeration system must only be carried out by certified skilled personnel (specialists). A certification in accordance with EC regulation 303/2008 must be available.



The requirements of the EC 842/2006 directive must be met under all circumstances.



Please refer to the indications on the name plate as regards the type and amount of refrigerant.



Comply with the following protective measures and rules of conduct:

1. **Storage:** Keep the container tightly closed. Keep it in a cool and dry place. Protect it against heat and direct sunlight. Keep it away from ignition sources.
2. **Handling:** Take measures against electrostatic charging. Ensure good ventilation/suction at the workplace. Check fittings, connections and ducts for tightness. Do not inhale the gas. Avoid contact with the eyes or the skin.
3. Prior to carrying out works on refrigerant-carrying parts, remove the refrigerant to such an extent that safe working is possible.
4. Do not eat, drink or smoke during work. Keep out of the reach of children.
5. **Breathing protection:** ambient-air-independent respirator (at high concentrations).
6. **Eye protection:** sealing goggles.
7. **Hand protection:** protective gloves (e.g. made of leather).
8. **Personal protection:** protective clothing.
9. **Skin protection:** use protective cream.

In addition, the safety data sheet for the refrigerant needs to be observed!

**Caution!****Hot surfaces!**

During operation, several components can reach surface temperatures of more than 140°F (60°C). There is the risk of burns.

All components concerned are installed inside of the closed housing. The housing must only be opened by certified skilled personnel³.

**Caution!****Improper use!**

The device is intended for the separation of water in compressed air. The dried air cannot be used for breathing-air purposes and is not suitable for the direct contact with food.

This dryer is not suitable for the treatment of contaminated air or of air containing solids.

³ Certified skilled personnel are persons who are authorised by the manufacturer, with experience and technical training, who are well-grounded in the respective provisions and laws and capable of carrying out the required works and of identifying and avoiding any risks during the machine transport, installation, operation and maintenance. Qualified and authorised operators are persons who are instructed by the manufacturer regarding the handling of the refrigeration system, with experience and technical training, and who are well-grounded in the respective provisions and laws.



Note!

Contaminated intake air!

In the event that the intake air is strongly contaminated (ISO 8573.1 class 3.-3 or poorer quality), we recommend the additional installation of a prefilter (5 micron minimum), to avoid clogging of the heat exchanger.



Caution!

Heating-up through fire!

In the event of a heating-up through fire, the containers and pipes of the refrigerant system can burst.



In this case, please proceed as follows:

Switch off the refrigeration plant.

Switch off the mechanical ventilation of the machinery compartment.

Use ambient-air-independent respirators.

Containers and plants which are filled with refrigerant can burst violently in the event of fire.

The refrigerants themselves are incombustible, but they are degraded to very toxic products at high temperatures.

Remove the container/plant from the fire zone, as there is the risk of bursting!

Cool down containers and bottles via a directed water jet from a safe position.

In the event of fire, please use an approved fire extinguisher. Water is not a suitable agent to extinguish an electrical fire.

This must only be carried out by persons who are trained and informed about the hazards emanating from the product.



Caution!

Unauthorised intervention!

Unauthorised interventions may endanger persons and plants and lead to malfunction.

Unauthorised interventions, modification and abuse of the pressure devices are prohibited.

The removal of sealings and leadings at safety devices is prohibited.

Operators of the devices must observe the local and national pressure equipment regulations in the country of installation.



Note!

Ambient conditions!

In the event that the dryer is not installed under suitable ambient conditions, the ability of the device to condense refrigerant gas is impaired. This can result in a higher load of the refrigerating compressor, and in a loss of efficiency and performance of the dryer.

This in turn leads to overheated condenser fan motors, to malfunction of electric components and to a breakdown of the dryer. Failures of this type will affect warranty considerations.

Do not install the dryer in an environment in which chemicals with a corrosive effect, explosive gases, toxic gases, evaporation heat, high ambient temperatures or extreme dust and dirt can be found.

3 Proper use

This dryer was designed, manufactured and tested to separate the moisture which normally exists in compressed air. Any other use is considered improper.

The manufacturer shall not be liable for problems occurring as a consequence of improper use. The user alone is responsible for any damage resulting from that.

Furthermore, the correct use includes the compliance with the installation instructions, in particular in respect of:

- The voltage and frequency of the main voltage supply.
- The pressure, temperature and flow rate of the inlet air.
- The ambient temperature.

When delivered, the dryer is tested and fully assembled. The customer only needs to connect the device to the system in accordance with the instructions in the following chapters.

4 Exclusion from a field of application



Note!
Improper use!



The device is intended for the separation of water in compressed air. The dried air cannot be used for breathing-air purposes and is not suitable for the direct contact with food.

This dryer is not suitable for the treatment of contaminated air or of air containing solids.

5 Operating instructions in accordance with the 2014/68/EU Pressure Equipment Directive

The DRS30-DRS125 compressed-air refrigeration dryer contains pressure equipment in the sense of the 2014/68/EU Pressure Equipment Directive. Therefore, the entire plant needs to be registered with the supervisory authority if required in accordance with the local regulations.

For the examination prior to the start-up and for periodic inspections, the national regulations need to be observed, such as the industrial safety regulation in the Federal Republic of Germany. In countries outside the EU, the respective regulations in force there need to be adhered to.

The proper use of pressure devices is the basic requirement for safe operation. As regards pressure devices, the following points need to be observed:

- The DRS30-DRS125 compressed-air refrigeration dryer must only be employed within the pressure and temperature range limits indicated by the manufacturer on the name plate.
- No welding must be carried out on the pressure parts.
- The DRS30-DRS125 compressed-air refrigeration dryer must neither be installed in insufficiently ventilated rooms nor near heat sources or inflammable substances.
- To avoid fractures resulting from material fatigue, the refrigeration dryer should not be exposed to vibrations during operation.
- The maximum operating pressure indicated by the manufacturer on the name plate must not be exceeded. It is the installer's responsibility to install the appropriate safety and control devices. Prior to the start-up of the DRS30-DRS125 compressed-air refrigeration dryer, the connected pressure generator (compressor etc.) must be set to the max. permissible operating pressure. The integrated safeguard needs to be checked by an approved inspection agency.
- The documents related to the DRS30-DRS125 compressed-air refrigeration dryer (manual, operating instructions, manufacturer's declaration etc.) must be kept safe for future reference.
- No objects whatsoever must be installed at or placed on the DRS30-DRS125 compressed-air refrigeration dryer and the connecting lines.
- Installation of the plant in frost-free places only.
- Operation of the plant is only permissible with fully closed and intact housing and cover panels. Operation of the plant with damaged housing/cover panels is prohibited.

6 Transport

Check the packaging for visible loss or damage. If no visible damage can be ascertained, place the unit in close proximity to the place of installation and unpack the device.

During this procedure, the dryer must always remain in an upright position. The components may be damaged when the unit is tilted or turned upside down.

Store the device in a dry environment and do not expose it to extreme weather conditions.

Handle with care. Strong shocks can cause irreparable damage.

7 Storage

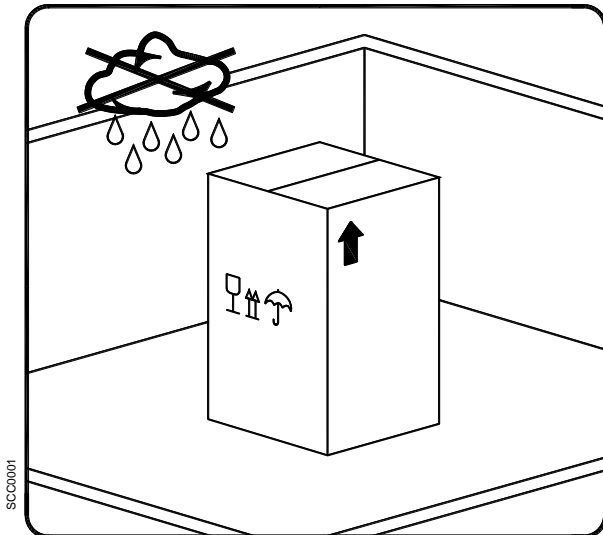

Keep the device away from extreme weather conditions even when packaged.

Keep the dryer in an upright position, also while it is stored. Tilting the device or turning it upside down can cause irreparable damage to some components.

When the dryer is not in use, it can be stored in its packaging in a dust-free and protected place at a temperature of +34°F ... +122°F (+1°C...+50°C) and at a specific humidity of max. 90%. If the storage period exceeds 12 months, you should contact the manufacturer.



The packaging material is recyclable. Dispose of the material in accordance with the directives and provisions in force in the country of destination

8 Installation

8.1 Place of installation



Note!

Ambient conditions!

In the event that the dryer is not installed under suitable ambient conditions, the ability of the device to condense refrigerant gas is impaired. This can result in a higher load of the refrigerating compressor, and in a loss of efficiency and performance of the dryer.

This in turn leads to overheated condenser fan motors, to malfunction of electric components and to a breakdown of the dryer. Failures of this type will affect warranty considerations.

Do not install the dryer in an environment in which chemicals with a corrosive effect, explosive gases, toxic gases, evaporation heat, high ambient temperatures or extreme dust and dirt can be found.

Minimum installation requirements:

- Choose an area which is clean and dry, free from dust and protected against atmospheric disturbances.
- The load-bearing zone must be even, horizontal and able to bear the weight of the dryer.
- Minimum ambient temperature +34°F (+1°C).
- Maximum ambient temperature +113°F (+45°C).
- Ensure a proper cooling air replacement.
- Allow a sufficient clearance on each side of the dryer for proper ventilation and to facilitate maintenance operations. The dryer does not require attachment to the floor surface.



Do not obstruct the ventilation grille (not even partially).

Prevent any recirculation of the outgoing cooling air.

Protect the dryer against draughts.

8.2 Installation plan

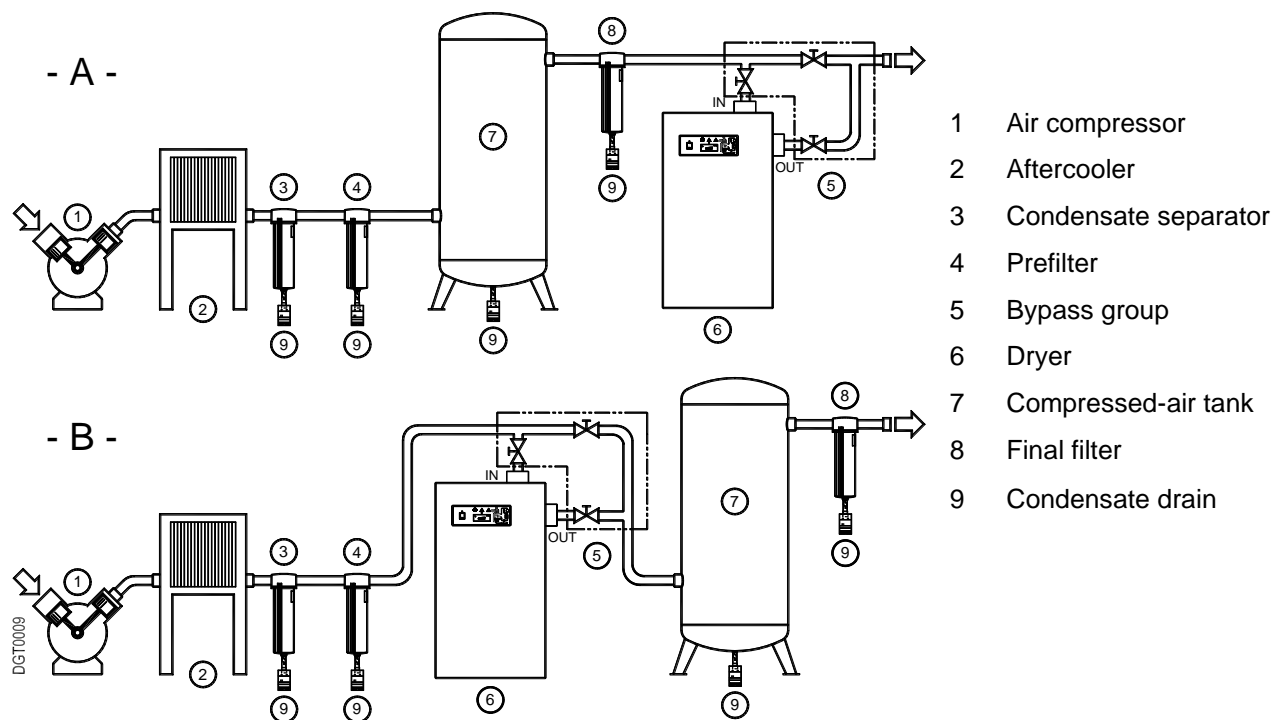

Installation **type A** is recommended when the total consumption corresponds to the throughput rate of the compressor. Installation **type B** is recommended when the air consumption constantly varies, with peak values which considerably exceed the throughput rate of the compressor. The storage capacity of the tank must be dimensioned in such a way that a possible short-term high air demand (peak air consumption) can be compensated.



Do not obstruct the ventilation grille (not even partially).

Prevent any recirculation of the outgoing cooling air.
Protect the dryer against draughts.



Note!

Contaminated intake air!

In the event that the intake air is strongly contaminated (ISO 8573.1 class 3.-3 or poorer quality), we recommend the additional installation of a prefilter (5 micron minimum), to avoid clogging of the heat exchanger.

Installation

8.3 Correction factors

Correction factor for operating pressure changes:

Inlet air pressure	psig	60	80	100	120	140	160	180	200
	barg	4.1	5.5	6.9	8.3	9.7	11.0	12.4	13.8
Factor (F1)		0.79	0.91	1.00	1.07	1.13	1.18	1.23	1.27

Correction factor for ambient temperature changes:

Ambient temperature	°F	≤ 80	90	100	105	110	115
	°C	≤ 27	32	38	41	43	46
Factor (F2)		1.12	1.09	1.00	0.93	0.85	0.75

Correction factor for inlet air temperature changes:

Air temperature	°F	≤ 80	90	100	110	120	130
	°C	≤ 27	32	38	43	49	54
Factor (F3)		1.24	1.23	1.00	0.81	0.66	0.54

How to find the air flow capacity:

Air flow capacity = Nominal duty x Factor (F1) x Factor (F2) x Factor (F3)

Example:

An **DRS 30** has a nominal duty of 30 scfm (51 m³/h). What is the maximum allowable flow through the dryer under the following operating conditions:

Inlet air pressure = 100 psig (6.9 barg)	Factor (F1) = 1.00
Ambient temperature = 90°F (32°C)	Factor (F2) = 1.09
Inlet air temperature = 110°F (43°C)	Factor (F3) = 0.81

Each item of data has a corresponding numerical factor which multiplied by the design air flow is as follows:

Air flow capacity = 30 x 1.00 x 1.09 x 0.81 = 26 scfm (44 m³/h)

26 scfm (44 m³/h) This is the maximum flow rate that the dryer can accept under these operating conditions.

How to select a suitable dryer for a given duty:

Minimum std. air flow rate = $\frac{\text{Design air flow}}{\text{Factor (F1) x Factor (F2) x Factor (F3) x Factor (F4)}}$

Example:

With the following operating parameters:

Design air flow = 40 scfm (68 m ³ /h)	Factor (F1) = 1.00
Inlet air pressure = 100 psig (6.9 barg)	Factor (F2) = 0.93
Ambient temperature = 105°F (41°C)	Factor (F3) = 1.00
Inlet air temperature = 100°F (38°C)	

In order to select the correct dryer model the required flow rate is to be divided by the correction factors relating to above mentioned parameters:

Minimum std. air flow rate = $\frac{40}{1.00 \times 0.93 \times 1.00} = 43 \text{ scfm (73 m}^3\text{/h)}$

Therefore the model suitable for the conditions above is **DRS 60 (60 scfm [102 m³/h] - nominal duty)**.

8.4 Connection to the compressed-air system



Danger! **Compressed air!**

All works must only be carried out by qualified skilled personnel.



Never work on compressed-air systems which are under pressure.

The operator or the user must ensure that the dryer is never operated with a pressure exceeding the maximum pressure value indicated on the name plate.

Exceeding the maximum operating pressure can be dangerous for the operator but also for the device.

The air temperature and the air flow at the inlet of the dryer must lie within the limit values indicated on the name plate. The connecting lines must be free from dust, iron rust, shards and other contaminations and correspond to the flow rate of the dryer. Should air with a very high temperature be treated, the installation of an aftercooler may be necessary. For the implementation of maintenance works, the installation of a bypass system is recommended.

The dryer was designed in such a manner that vibrations that may occur during operation are limited. Therefore, it is advisable to employ connecting lines (flexible hoses, vibration-inhibiting fittings etc.) which protect the dryer against possible vibrations in the pipework.

Note!



Contaminated intake air!

In the event that the intake air is strongly contaminated (ISO 8573.1 class 3.-3) or poorer quality, we recommend the additional installation of a prefilter (5 micron minimum), to avoid clogging of the heat exchanger.

8.5 Electrical connections



Danger! **Supply voltage!**

The connection to the electric mains should only be carried out by qualified skilled personnel and must correspond to the legal provisions in force in your region.

Prior to connecting the device, please check the name plate to avoid exceeding the indicated values. The voltage tolerance is +/- 10%.

DRS 30-100 dryers are supplied with a power cord and safety plug (two-pole and earth connection).

Make sure that suitable fuses or circuit breakers in accordance with the indications on the name plate are available.

A residual-current device (RCD) with $I_{\Delta n} = 0.03A$ is suggested. The cross-section of the power supply cable must correspond to the power consumption of the dryer. In this respect, the ambient temperature, the cable laying conditions, the length of the cables and the requirements of the local electricity supplier need to be considered.



Danger! **Supply voltage and missing earth connection!**

Important: ensure that the plant is connected to earth.

Do not use plug adapters at the power plug.

Possible replacement of the power plug must only be carried out by a qualified electrician.

8.6 Condensate drain



Danger!
Compressed air and condensate under pressure!

The condensate is discharged at system pressure.



The drain pipe needs to be secured.

Never direct the condensate drain pipe at persons.

The dryer is delivered with an already integrated timed condensate drain. Connect the condensate drain with a collection system or container by properly screwing it on.

Do not connect the drain with pressurised plants.



Do not discharge the condensate into the environment.

The condensate accumulating in the dryer contains oil particles which were released into the air by the compressor.

Dispose of the condensate in accordance with the local provisions.

It is advisable to install a water-oil separator, to which the total amount of condensate from the compressors, dryers, tanks, filters etc. is supplied.

We recommend an oil-water separator for dispersed compressor condensate and an emulsion-splitting plant for emulsified condensate.

9 Start-up

9.1 Preliminary stages



Note!
Exceeding of the operating parameters!

Ensure that the operating parameters comply with the nominal values indicated on the name plate of the dryer (voltage, frequency, air pressure, air temperature, ambient temperature etc.).

Prior to delivery, this dryer was thoroughly tested, packed and checked. Please verify the soundness of the dryer during the initial start-up and check the perfect functioning during the first operating hours.



The initial start-up must be carried out by qualified personnel.

During the installation and operation of this device, all national regulations regarding electronics and any other federal and state ordinances, as well as local provisions, need to be adhered to.



The operator and the user must ensure that the dryer is not operated without panels.

9.2 Initial start-up



Note!

The dryer **must not be started up more than six times an hour**. Wait at least five minutes prior to every restart.

The user is responsible for the compliance with these provisions. Irreparable damage can be caused by starting up the device too often.



The method below should be applied during the first start-up, after longer downtimes or subsequent to maintenance works.

The start-up must be carried out by certified skilled personnel.

Processing sequence (see Section 11.1 "Control panel")

- Ensure that all steps of the "Installation" chapter have been carried out.
- Ensure that the connection to the compressed-air system is in accordance with the provisions and that the lines are fixed and supported properly.
- Ensure that the condensate drain pipe is fixed in accordance with the provisions and that it is connected with a collection system or a container.
- Ensure that the bypass system (if installed) is open and that the dryer is disconnected from the compressed-air system.
- Ensure that the manual valve of the condensate drainage cycle is open.
- Remove any packaging material and other items which may block the space around the dryer.
- Establish the mains connection (plug into socket).
- Start the dryer by switching on the main switch on the control panel (pos. 1).
- Make sure that the electronic control unit is switched on.
- Ensure that the power consumption complies with the values on the name plate.
- **Ensure that the fan runs properly – wait for the first interventions.**
- Wait until the dew point remains stable.
- Slowly open the air inlet valve.
- Slowly open the air outlet valve.
- Slowly close the central bypass valve of the system (if installed).
- Check the pipes for air leakage.
- Ensure the proper functioning of the condensate drain cycle (wait for the first condensate discharges).



Note!

A DewPoint included in the green operating area of the electronic controller is correct according to the possible working conditions (flow-rate, temperature of the incoming air, ambient temperature, etc.)

During the operation, the refrigerating compressor runs continuously. The dryer needs to be switched on during the entire compressed-air usage time, even if the compressed-air compressor works periodically.



Shut down (see Section 11.1 "Control panel")

- Ensure that the dew point temperature indicated on the electronic control unit is stable.
- Interrupt the compressed-air supply.
- After a few minutes, stop the dryer by switching off the main switch on the control panel (pos. 1).



Restart (see Section 11.1 "Control panel")

- Make sure that the condenser is clean
- Check whether or not voltage is applied at the dryer.
- Start the dryer by switching on the main switch on the control panel (pos. 1).
- Ensure that the electronic control unit is switched on.
- Wait a few minutes and then check, whether or not the dew point temperature indicated on the electronic control unit is stable and whether or not the condensate is drained off at regular intervals.
- Establish the compressed-air supply.

During the operation, the refrigerating compressor runs continuously. The dryer needs to be switched on during the entire compressed-air usage time, even if the compressed-air compressor works periodically.



Note!

A DewPoint included in the green operating area of the electronic controller is correct according to the possible working conditions (flow-rate, temperature of the incoming air, ambient temperature, etc.)



Note!

The dryer **must not be started up more than six times an hour**. Wait at least five minutes prior to every restart.

The user is responsible for the compliance with these provisions. Irreparable damage can be caused when starting up the device too often.

10 Technical data

MODEL	DRS##-1_JT						
Air flow rate at nominal condition (1)	[scfm]	030	040	060	080	100	125
	[m ³ /h]	30	40	60	80	100	125
	[l/min]	51	68	102	136	170	212
Pressure DewPoint at nominal condition (1)	[°F (°C)]	849	1132	1698	2264	2830	3538
Nominal ambient temperature	[°F (°C)]	50 (10)					
Min...Max ambient temperature	[°F (°C)]	100 (38)					
Nominal inlet air temperature	[°F (°C)]	34...113 (1...45)					
Nominal inlet air pressure	[psig (barg)]	100 (38) max.131 (55)					
Max. inlet air pressure	[psig (barg)]	100 (7)					
Air pressure drop - Δp	[psi (bar)]	1.3 (0.09)	1.7 (0.12)	2.5 (0.17)	3.5 (0.24)	4.6 (0.32)	3.5 (0.24)
Inlet - Outlet connections	[NPT-F]	1/2" 1" 1 1/4"					
Refrigerant type		R134.a					
Refrigerant quantity (2)	[oz (kg)]	7.1/2 (0.21)	7.3/4 (0.22)	8.3/4 (0.25)	10.1/2 (0.30)	11.1/2 (0.33)	14.1/2 (0.41)
Cooling air fan flow	[cfm (m ³ /h)]	180 (300)					
Heat Rejection	[btu/hr (kW)]	1860 (0.55)	2300 (0.68)	2350 (0.69)	3240 (0.95)	4950 (1.45)	13490 (3.95)
Standard Power Supply (2)	[Ph/V/Hz]	1/115/60					
Nominal electric consumption	[kW]	0.21	0.22	0.30	0.36	0.49	1.00
	[A]	2.6	2.7	3.8	4.5	5.2	7.6
Total input current	[A]	2.7	3.7	4.0	4.5	4.6	10.2
Minimum Circuit Ampacity (MCA)	[A]	3.4	4.6	4.9	5.5	5.6	12.6
Maximum rating of Overcurrent Protective device (MOP)	[A]	5.9	8.1	8.4	9.5	9.7	22.1
Fuse max.	[A]	5	8	8	9	9	20
Max. noise level at 1 m	[dbA]	< 70					
Weight	[lb (kg)]	53 (24)	55 (25)	60 (27)	64 (29)	71 (32)	88 (40)

(1) The nominal condition refers to an ambient temperature of 100°F (38°C) with inlet air at 100 psig (7 barg) and 100°F (38°C).

(2) Check the data shown on the identification plate.

11 Technical description

11.1 Control panel

The control panel explained below is the only dryer user interface.

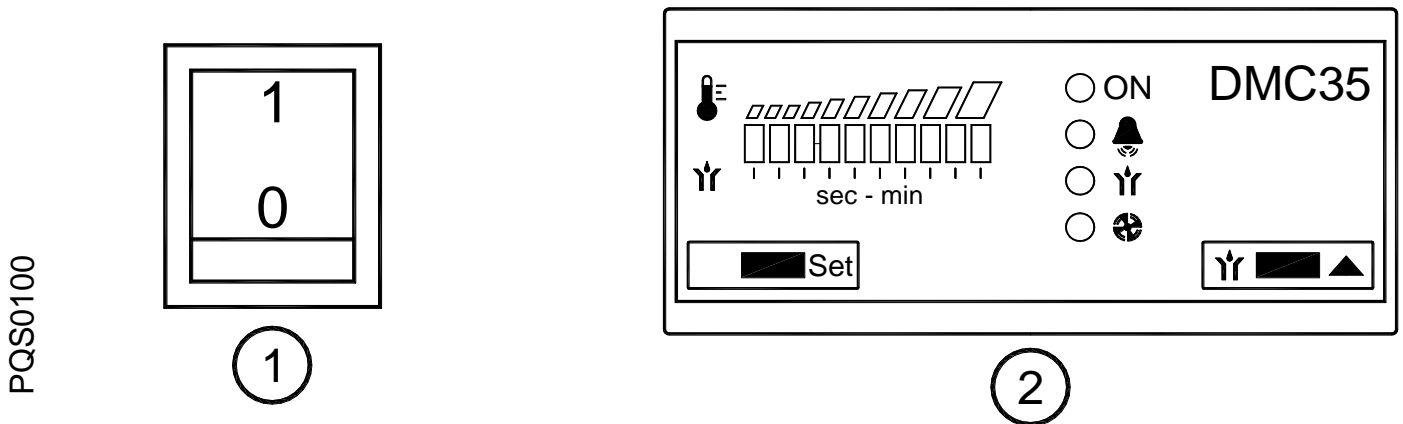

- 1 ON-OFF Switch
- 2 Electronic instrument

11.2 Functional description

Operating principle – All dryer models described in this manual function according to the same principle. The hot and moisture-loaded air is led into an air/air heat exchanger. Afterwards, the air flows through an evaporator, which is also known as an air/refrigerant heat exchanger. The air temperature is reduced to approximately 36°F (2°C), so that water vapour condenses to liquid. The continuously accumulating condensate is collected in the separator to be discharged via the condensate drain. Subsequently, the cold and dry air is led through the air/air heat exchanger, so that it is reheated to up to 15°F (8°C) below the inlet temperature when leaving the dryer.

Refrigeration cycle – The refrigerant is conducted through the compressor and reaches a condenser under high pressure. There, cooling-down takes place, making the refrigerant condense to a liquid state which is under high pressure. The liquid is pressed through a capillary tube where the resulting pressure drop ensures that the refrigerant evaporates at a defined temperature. The liquid refrigerant which is under low pressure is led into the heat exchanger, where it expands. The cold resulting from the expansion serves to cool down the compressed air in the heat exchanger. During this process, the refrigerant evaporates. The low-pressure gas is resupplied to the compressor, where it is compressed again. It then re-enters the cycle. In phases of a reduced compressed-air load, the excess refrigerant is resupplied automatically to the compressor via the hot gas bypass valve.

11.3 Flow chart

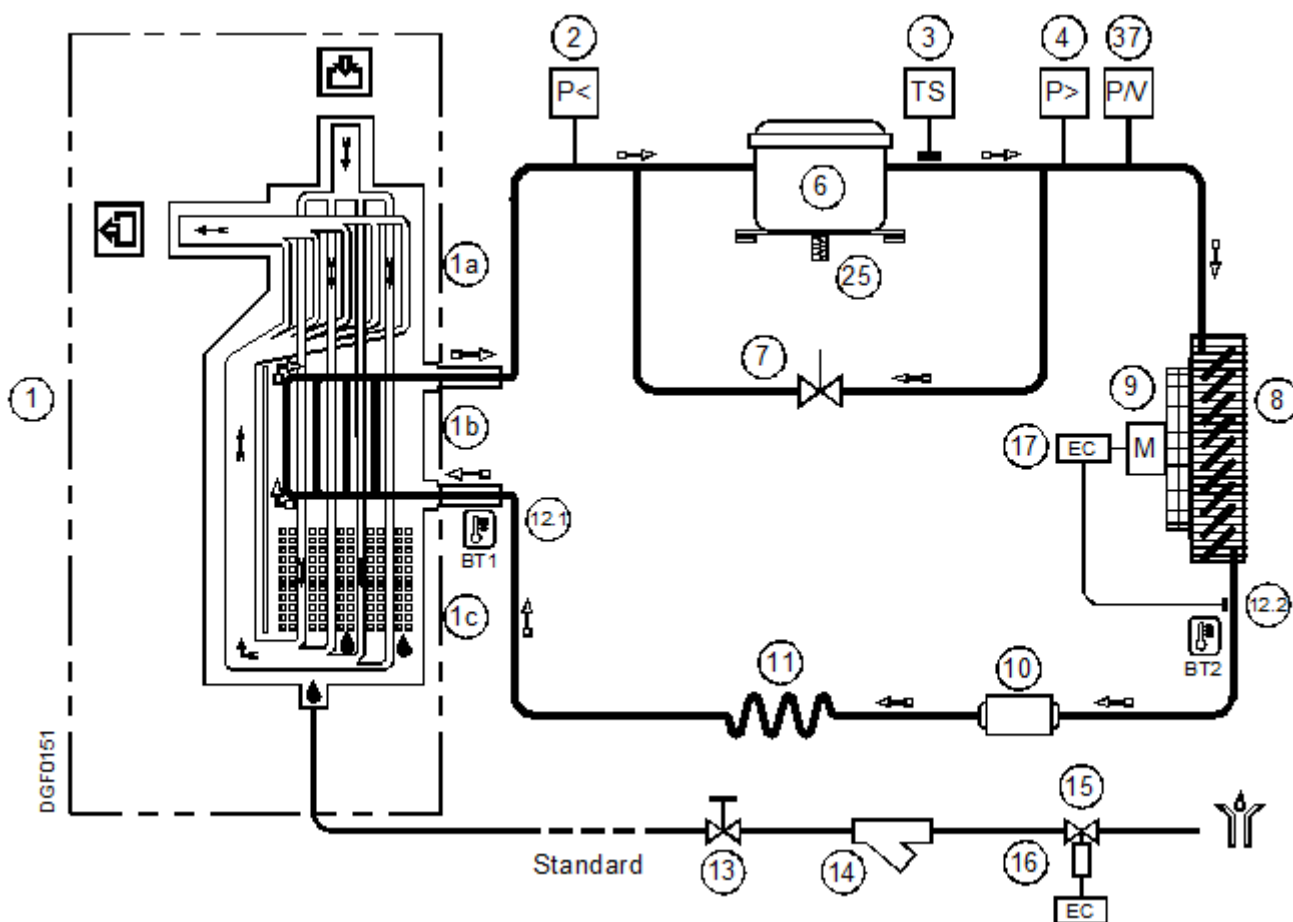

- | | |
|---|---|
| <ul style="list-style-type: none"> 1 Alu-Dry module 1a Air-to-air heat exchanger 1b Air-to-refrigerant heat exchanger 1c Condensate separator 2 Not installed 3 Not installed 4 Not installed 6 Compressor 7 Hot gas by-pass valve 8 Condenser 9 Condenser fan | <ul style="list-style-type: none"> 10 Filter dryer 11 Capillary tube 12.1 Temperature probe BT1 – DewPoint 12.2 Temperature probe BT2 – Fan control 13 Condensate drain service valve 14 Condensate drain strainer 15 Condensate drain solenoid valve 16 Coil for condensate drain solenoid valve 17 Electronic instrument 37 Pressure transducer BP2 |
|---|---|

⇒ Compressed air flow direction

⇒ Refrigerant gas flow direction

Technical description

11.4 Refrigerating compressor

The employed refrigerating compressors are constructed by leading manufacturers. The hermetically sealed construction is absolutely gastight. The integrated safeguard protects the compressor against overheating and excess current. The protection is automatically reset as soon as the nominal conditions are reached again.

11.5 Condenser

The condenser is the component in which the gas coming from the compressor is cooled down, condensed and liquefied. Under no circumstances must the temperature of the ambient air exceed the nominal values. It is also important that the condenser unit is kept free from dust and other impurities.

11.6 Filter dryer

Despite controlled vacuuming, traces of moisture can accumulate in the refrigeration cycle. The filter dryer serves to absorb this moisture and to bond it.

11.7 Capillary tube

The capillary tube is a copper tube with a reduced diameter which is located between the condenser and the evaporator, serving as a restrictor to reduce the pressure of the refrigerant. The pressure reduction serves to reach an optimum temperature inside of the evaporator. The lower the outlet pressure at the capillary tube, the lower the evaporation temperature.

The length and the inner diameter of the capillary tube are exactly dimensioned to ensure the performance of the dryer. Settings or maintenance works are not required.

11.8 Aluminium heat exchanger

The heat exchanger module consists of an air/air heat exchanger, an air/refrigerant heat exchanger, and of a high-performance separator. The compressed air flows top-down through the heat exchanger. The large cross-sections of the flow passages cause low flow rates and low compressed-air losses. In the air/air heat exchanger, the heat exchange is effected in a reverse current. This guarantees maximum heat transfer. The heat transfer in the air/refrigerant heat exchanger also takes place in a reverse current. This allows full evaporation of the refrigerant. The high-performance separator ensures almost complete separation of the condensate. Maintenance of the high-performance separator is not required.

11.9 Hot-gas bypass valve

At partial load, the valve directly returns a part of the hot gas to the suction line of the refrigerating compressor. The evaporation temperature and the evaporation pressure remain constant.



ADJUSTMENT

The hot gas by-pass valve is adjusted during the manufacturing testing phase. As a rule no adjustment is required; anyway if it is necessary the operation must be carried out by an experienced refrigerating engineer.

WARNING

the use of 1/4" Schrader service valves must be justified by a real malfunction of the refrigerating system. Each time a pressure gauge is connected, a part of refrigerant is exhausted.

Without compressed air flow through the dryer, rotate the adjusting screw (position A on the drawing) until the following value is reached:

Hot gas setting :

R134.a pressure 29.0 psig (+ 1.45 / -0 psi) [2.0 barg (+0.1 / -0 bar)]

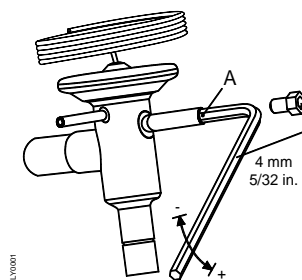

11.10 Electronic instrument DMC35

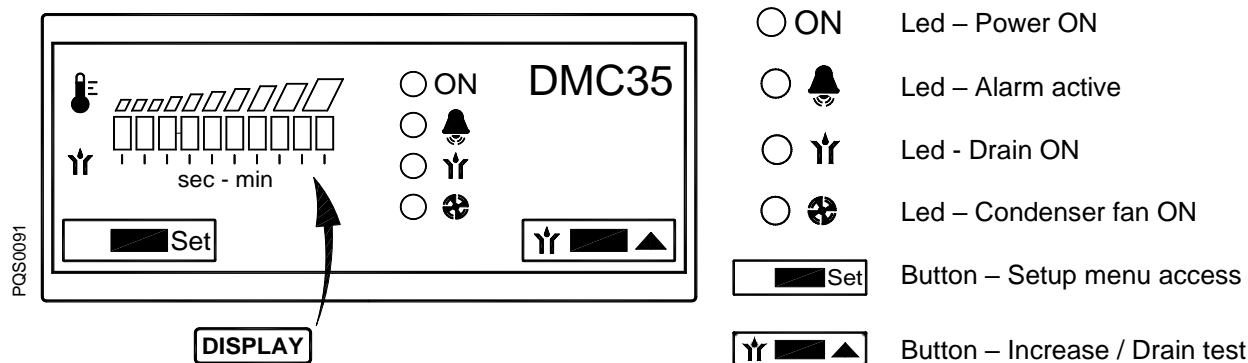

The DMC35 displays DewPoint temperature, controls the condenser fan activation, controls the timed drainer and keep record of the total hours of operation of the dryer.

11.10.1 How to switch on the dryer

Power the dryer and switch it on using the ON-OFF switch (pos.1 paragraph 7.1).

During normal operation led ON is ON and the display shows the DewPoint temperature by means of two coloured areas (green and red) above a 10 Led display :

- Green area - operating conditions ensuring an optimal DewPoint;
- Red area - DewPoint too high, the dryer is operating with high thermal load (high inlet air temperature, high ambient temperature, etc.). Compressed air treatment may be improper.

Led shows that one or more service warnings / alarms are active.

Led shows that condensate drain solenoid valve is ON.

Led shows that condenser fan is ON.

The condensate drain test is always active using the button .

11.10.2 How to switch off the dryer

Switch it off using the ON-OFF switch (pos. 1 paragraph 7.1).

11.10.3 How a service warning / alarm is displayed

A service warning / alarm is an unusual event that must recall the attention of the operators / maintenance technicians. It does not stop the dryer.



Service warnings / alarms are automatically reset as soon as the problem is solved and dryer is powered again.



NOTE: the operator / maintenance technician must inspect the dryer and verify / solve the problem that generated the service warning.

Service Warning / Alarm	Description
Led and display 1st (left) and 10th (right) led are flashing	Failure BT1 (DewPoint) temperature probe.
Led and led are flashing	Failure BT2/BP2 (fan control) probe. NOTE : fan is forced always ON.
Led and display 1st (left) led are flashing	DewPoint too low (lower than -1°C / 30°F).



Technical description

11.10.4 How is controlled the condenser fan



DRS 30-100 A temperature probe BT2 is located on the discharge side of the condenser. The condenser fan is activated (ON) when the BT2 temperature is higher than FANon setting (approx. 35°C/96°F) and led   is ON. Condenser fan stops when BT2 temperatures is lower than FANoff setting (approx. 30°C/86°F).

DRS 125 A pressure probe BP2 is located on the discharge side of the compressor. The condenser fan is activated (ON) when the BP2 pressure is higher than FANon setting (approx. 18 barg/260 psig) and led   is ON. Condenser fan stops when BP2 pressure is lower than FANoff setting (approx. 14 barg/203 psig).

11.10.5 How is controlled the drain solenoid valve



Drain solenoid valve is activated (ON) for T_{ON} seconds (standard 2 seconds) every T_{OFF} minutes (standard 1 minute). Led   shows that condensate drain solenoid valve is ON.



The condensate drain test is always active using the button .



NOTE : if an electronic drainer is installed, DMC35 is set to keep always powered the drain output, Led   is always OFF and condensate drain test does not work.



11.10.6 How to display the total hours of operation

Total hours of operation are recorded into DMC35 and are shown through the dew point indication bar (max value 109900 hours, cannot be reset).

With dryer ON press buttons  and  for at least 5 seconds.

Led   is lit and a certain numbers of leds of dew point indication bar are light up. The number of leds lit define the 1st digit of hour counter (ie : no leds lit → 1st digit =0)

Press  button, led   is lit and a certain numbers of leds of dew point indication bar are light up. The number of leds lit define the 2nd digit of hour counter (ie : n.3 leds lit → 2nd digit = 3)

Press  button, led   is lit and a certain numbers of leds of dew point indication bar are light up. The number of leds lit define the 3rd digit of hour counter (ie : n.8 leds lit → 3rd digit = 8)

Total operating hours : 0 3 8 x 100 (fixed multiplying ratio) = 3800 hours

Press  button repeatedly to scroll the displaying of 3 digits again.

Press  button to exit total hours display (if no button is pressed after 30 seconds the menu is exited automatically).

11.10.7 How to change the operating parameters – SETUP menu



The setup menu can be used to change the dryer's operating parameters.



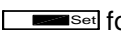



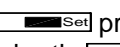
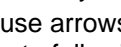
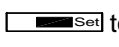

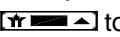

Only qualified personnel must be allowed to access to the setup menu. The manufacturer is not responsible for malfunctioning or failure due to modification to the operating parameters.

With dryer ON press button  for at least 2 seconds to enter the setup menu.



Access to the menu is confirmed by led   flashing.

Keep  pressed and use arrows  to change the value. Release the button  to confirm the value. Press shortly  to skip to following parameter.

Press  to exit setup menu (if no button is pressed after 2 minutes the menu is exited automatically).

Display	Description	Limits	Resolution	Standard setup
Synchronous flashing led   + led  	T_{ON} – drain time ON : time ON condensate drain valve	1 ... 6 sec	1 sec	2
Non-Synchronous flashing led   + led  	T_{OFF} - drain time OFF : pause time for condensate drain valve	1 ... 10 min	1 min	1

NOTE : parameter values are displayed on the 10 led display where 1st (left) led is the lowest limit and 10th (right) is the highest limit.

NOTE (1): T_{ON} set at the 10th led (right) keep drain output always powered and led   always off (used if electronic drainer is installed)

12 Maintenance, troubleshooting, spare parts and dismantling

12.1 Checks and maintenance



Certified skilled personnel

Installation works must exclusively be carried out by authorised and qualified skilled personnel. Prior to undertaking any measures on the DRS30-DRS125 compressed-air refrigeration dryer, the certified skilled personnel⁴ shall read up on the device by carefully studying the operating instructions. The operator is responsible for the adherence to these provisions. The respective directives in force apply to the qualification and expertise of the certified skilled personnel.

For safe operation, the device must only be installed and operated in accordance with the indications in the operating instructions. In addition, the national and operational statutory provisions and safety regulations, as well as the accident prevention regulations required for the respective case of application, need to be observed during employment. This applies accordingly when accessories are used.



Danger!

Compressed air!

Risk of serious injury or death through contact with quickly or suddenly escaping compressed air or through bursting and/or unsecured plant components.

Compressed air is a highly dangerous energy source.

Never work on the dryer when the system is under pressure.

Never direct the compressed-air outlet or condensate drain hoses at persons.

The user is responsible for the proper maintenance of the dryer. Non-observance of the instructions in the "Installation" and "Maintenance, troubleshooting, spare parts and dismantling" chapters leads to the expiration of the guarantee. Improper maintenance may result in dangerous situations for the personnel and/or the device.



Danger!

Supply voltage!

Contact with non-insulated parts carrying supply voltage involves the risk of an electric shock resulting in injuries and death.

Only qualified and skilled personnel are authorised to run electrically-operated devices. Prior to undertaking maintenance measures at the device, the following requirements must be met:

Make sure that the power supply is switched off and that the device is off and marked for maintenance measures. Please also ensure that the power supply cannot be re-established during the works.



Prior to carrying out maintenance works at the dryer, switch it off and wait for at least 30 minutes.



Caution!

Hot surfaces!

During operation, several components can reach surface temperatures of more than 140°F (60°C). There is the risk of burns.

All components concerned are installed inside of the closed housing. The housing must only be opened by certified skilled personnel.

Some components can reach high temperatures during operation. Avoid any contact until the system or the component has cooled down.

⁴ Certified skilled personnel are persons who are authorised by the manufacturer, with experience and technical training, who are well-grounded in the respective provisions and laws and capable of carrying out the required works and of identifying and avoiding any risks during the machine transport, installation, operation and maintenance. Qualified and authorised operators are persons who are instructed by the manufacturer regarding the handling of the refrigeration system, with experience and technical training, and who are well-grounded in the respective provisions and laws.



DAILY:

- Check whether the dew point indicated on the electronics is correct.
- Ensure that the condensate drain system functions properly.
- Make sure that the condenser is clean.

EVERY 200 HOURS OR MONTHLY



- Clean the condenser using an air jet (max. 2 bar / 30 psig) inside out. Make sure not to damage the aluminium lamellae of the cooling package.
- Finally, verify the operation of the device.

EVERY 1,000 HOURS OR ANNUALLY



- Verify all screws, clamps and connections of the electric system to make sure that they are fastened securely. Check the device for broken and ruptured cables or cables without insulation.
- Check the refrigeration cycle for signs of oil and refrigerant leaks.
- Measure the current strength and note it down. Ensure that the read values are within the permissible limit values, as indicated in the specification table.
- Check the hose lines of the condensate drain and replace them, if required.
- Finally, verify the operation of the device.

12.2 Troubleshooting



Certified skilled personnel

Installation works must exclusively be carried out by authorised and qualified skilled personnel. Prior to undertaking any measures on the DRS30-DRS125 compressed-air refrigeration dryer, the certified skilled personnel shall read up on the device by carefully studying the operating instructions. The operator is responsible for the adherence to these provisions. The respective directives in force apply to the qualification and expertise of the certified skilled personnel.

For safe operation, the device must only be installed and operated in accordance with the indications in the operating instructions. In addition, the national and operational statutory provisions and safety regulations, as well as the accident prevention regulations required for the respective case of application, need to be observed during employment. This applies accordingly when accessories are used.



Danger!

Compressed air!

Risk of serious injury or death through contact with quickly or suddenly escaping compressed air or through bursting and/or unsecured plant components.

Compressed air is a highly dangerous energy source.

Never work on the dryer when the system is under pressure.

Never direct the compressed-air outlet or condensate drain hoses at persons.

The user is responsible for the proper maintenance of the dryer. Non-observance of the instructions in the "Installation" and "Maintenance, troubleshooting, spare parts and dismantling" chapters leads to the expiration of the guarantee. Improper maintenance may result in dangerous situations for the personnel and/or the device.



Danger!

Supply voltage!

Contact with non-insulated parts carrying supply voltage involves the risk of an electric shock resulting in injuries and death.

Only qualified and skilled personnel are authorised to run electrically-operated devices. Prior to undertaking maintenance measures at the device, the following requirements must be met:

Make sure that the power supply is switched off and that the device is off and marked for maintenance measures. Please also ensure that the power supply cannot be re-established during the works.



Prior to carrying out maintenance works at the dryer, switch it off and wait for at least 30 minutes.











Caution!
Hot surfaces!

During operation, several components can reach surface temperatures of more than 140°F (60°C). There is the risk of burns.

All components concerned are installed inside of the closed housing. The housing must only be opened by certified skilled personnel.

Some components can reach high temperatures during operation. Avoid any contact until the system or the component has cooled down.

SYMPTOM	POSSIBLE CAUSE - SUGGESTED ACTION
◆ The dryer doesn't start.	⇒ Verify that the system is powered. ⇒ Verify the electric wiring.
◆ The compressor doesn't work.	⇒ Activation of the compressor internal thermal protection - wait for 30 minutes, then retry. ⇒ Verify the electric wiring. ⇒ If installed - Replace the internal thermal protection and/or the start-up relay and/or the start-up capacitor and/or the working capacitor. ⇒ If the compressor still doesn't work, replace it.
◆ Condenser's fan doesn't work.	⇒ Verify the electric wiring. ⇒ The DMC35 electronic instrument is faulty – replace it. ⇒ There is a leak in the refrigerant circuit - contact a refrigeration engineer. ⇒ If the fan still doesn't work, replace it.
◆ DewPoint too high.	⇒ The dryer doesn't start - see specific point. ⇒ The DewPoint probe BT1 doesn't correctly detect the temperature - ensure the sensor is pushed into the bottom of probe well. ⇒ The Compressor doesn't work - see specific point. ⇒ The ambient temperature is too high or the room aeration is insufficient - provide proper ventilation. ⇒ The inlet air is too hot - restore nominal conditions. ⇒ The inlet air pressure is too low - restore nominal conditions. ⇒ The inlet air flow rate is higher than the rate of the dryer - reduce the flow rate - restore nominal conditions. ⇒ The condenser is dirty - clean it. ⇒ The condenser fan doesn't work - see specific point. ⇒ The dryer doesn't drain the condensate - see specific point. ⇒ The hot gas by-pass valve is out of setting - contact a refrigeration engineer to restore nominal setting. ⇒ There is a leak in the refrigerant circuit - contact a refrigeration engineer.
◆ Dew Point too low	⇒ The fan is always ON - the  yellow LED of DMC35 electronic instrument is flashing - see specific point. ⇒ Ambient temperature is too low - restore nominal conditions. ⇒ The hot gas by-pass valve is out of setting - contact a refrigeration engineer to restore nominal setting.

SYMPTOM	POSSIBLE CAUSE - SUGGESTED ACTION
◆ Excessive pressure drop within the dryer.	<ul style="list-style-type: none"> ⇒ The dryer doesn't drain the condensate - see specific point. ⇒ The DewPoint is too low - the condensate is frost and blocks the air - see specific point. ⇒ Check for throttling the flexible connection hoses.
◆ The dryer doesn't drain the condensate	<ul style="list-style-type: none"> ⇒ The condensate drain service valve is closed - open it. ⇒ Condensate strainer is clogged – remove and clean it. ⇒ The drain solenoid valve is jammed – remove and clean it. ⇒ Verify the electric wiring. ⇒ The coil of the drain solenoid valve is failed – replace it. ⇒ Electronic instrument is faulty – replace it. ⇒ The DewPoint is too low - the condensate is frost and blocks the air - see specific point. ⇒ Inlet compressed air pressure is too low and condensate is not drained – restore nominal conditions.
◆ The dryer continuously drains condensate.	<ul style="list-style-type: none"> ⇒ The drain solenoid valve is jammed – remove and clean it. ⇒ Try to remove the electric connector on the solenoid valve - if drain stops verify the electric wiring or the electronic instrument is faulty - replace it
◆ Water within the line.	<ul style="list-style-type: none"> ⇒ The dryer doesn't start - see specific point. ⇒ If installed - Untreated air flows through the by-pass unit - close the by-pass. ⇒ The dryer doesn't drain the condensate - see specific point. ⇒ DewPoint too high - see specific point.
◆ DMC35 - Led   and display 1st (left) and 10th (right) led are flashing.	<ul style="list-style-type: none"> ⇒ Verify the electric wiring of BT1 DewPoint probe. ⇒ The BT1 DewPoint probe is faulty - replace it. ⇒ The electronic instrument is faulty - replace it.
◆ DMC35 Led   and led   are flashing	<ul style="list-style-type: none"> ⇒ Verify the electric wiring of BT2/BP2 fan control probe. ⇒ The BT2/BP2 fan control probe is faulty - replace it. ⇒ The electronic instrument is faulty - replace it.
◆ DMC35 Led   and display 1st (left) led are flashing	<ul style="list-style-type: none"> ⇒ DewPoint too low - see specific point. ⇒ The BT1 DewPoint probe is faulty - replace it. ⇒ The electronic instrument is faulty - replace it.
◆ DMC35 Display 10th (right) led is flashing	<ul style="list-style-type: none"> ⇒ DewPoint too high - see specific point. ⇒ The BT1 DewPoint probe is faulty - replace it. ⇒ The electronic instrument is faulty - replace it.

12.3 Recommended spare parts

The suggested spare parts list will enable you to promptly intervene in case of abnormal operation, so avoiding to wait for the spares delivery. In case of failure of other parts, for example inside the refrigerating circuit, the replacement must be worked out by a refrigerating systems specialist or in our factory.

NOTE: To order the suggested spare parts or any other part, it's necessary to quote the data reported on the identification plate.

ID N.		DESCRIPTION	DRS###-1_JT					
			30	40	60	80	100	125
6	MC	Compressor	1	1	1	1	1	1
7		Hot gas by-pass valve	1	1	1	1	1	1
9.1	MV	Fan motor	1	1	1	1	1	1
9.2		Fan blade	1	1	1	1	1	1
9.3		Fan grid			1	1	1	1
10		Filter drier	1	1	1	1	1	1
12	BT	Temperature probe	2	2	2	2	2	1
13-14		Condensate drain valve/strainer	1	1	1	1	1	1
15	EVD	Condensate drain solenoid valve	1	1	1	1	1	1
16		Coil for condensate drain solenoid valve	1	1	1	1	1	1
17	DMC35	Electronic instrument	1	1	1	1	1	1
22	S1	Lighted switch	1	1	1	1	1	1
37	BP2	Pressure transducer						1

12.4 Maintenance works at the refrigeration cycle



Caution! Refrigerant!

Maintenance and repair works at refrigeration systems must only be carried out by KAISHAN service technicians in accordance with the local provisions.

The total amount of refrigerant in the system must be collected for recycling purposes, resource recovery or disposal.

The refrigerant must not be discharged into the environment.

When delivered, the dryer is ready to operate and filled with a refrigerant of the R134a type.



Should you detect a refrigerant leak, please contact a KAISHAN service technician. Prior to any intervention, the room needs to be ventilated.

When the refrigeration cycle needs to be refilled, please also contact a KAISHAN service technician.

You will find the refrigerant type and amount on the name plate of the dryer.

Properties of the refrigerants used:

Refrigerant	Chemical formula	MIK	GWP
R134a - HFC	CH ₂ FCF ₃	1000 ppm	1430
R407C - HFC	R32/125/134a (23/25/52) CHF ₂ CF ₃ /CH ₂ F ₂ /CH ₂ FCF ₃	1000 ppm	1773.85

12.5 Dismantling the dryer

When the dryer is dismantled, all parts and operating materials related to the plant need to be disposed of separately.



Component	Material
Refrigerant	R134a, R407C, oil
Roof and supports	Structural steel, epoxy paint coat
Refrigerating compressor	Steel, copper, aluminium, oil
Aluminium heat exchanger	Aluminium
Condenser unit	Aluminium, copper, structural steel
Pipe	Copper
Fan	Aluminium, copper, steel
Valve	Brass, steel
Condensate drain	PVC, aluminium, steel
Insulant	Synthetic rubber without CFCs, polysterene, polyurethane
Electric cable	Copper, PVC
Electric parts	PVC, copper, brass



We recommend observing the safety provisions in force for the disposal of each material type.

The refrigerant contains lubricating-oil droplets which are released by the compressor.

The refrigerant must not be discharged into the environment. It must be recovered from the dryer using a suitable device, and then needs to be supplied to a collection point.

13 Appendices

13.1 Dryer dimensions DRS 30-40

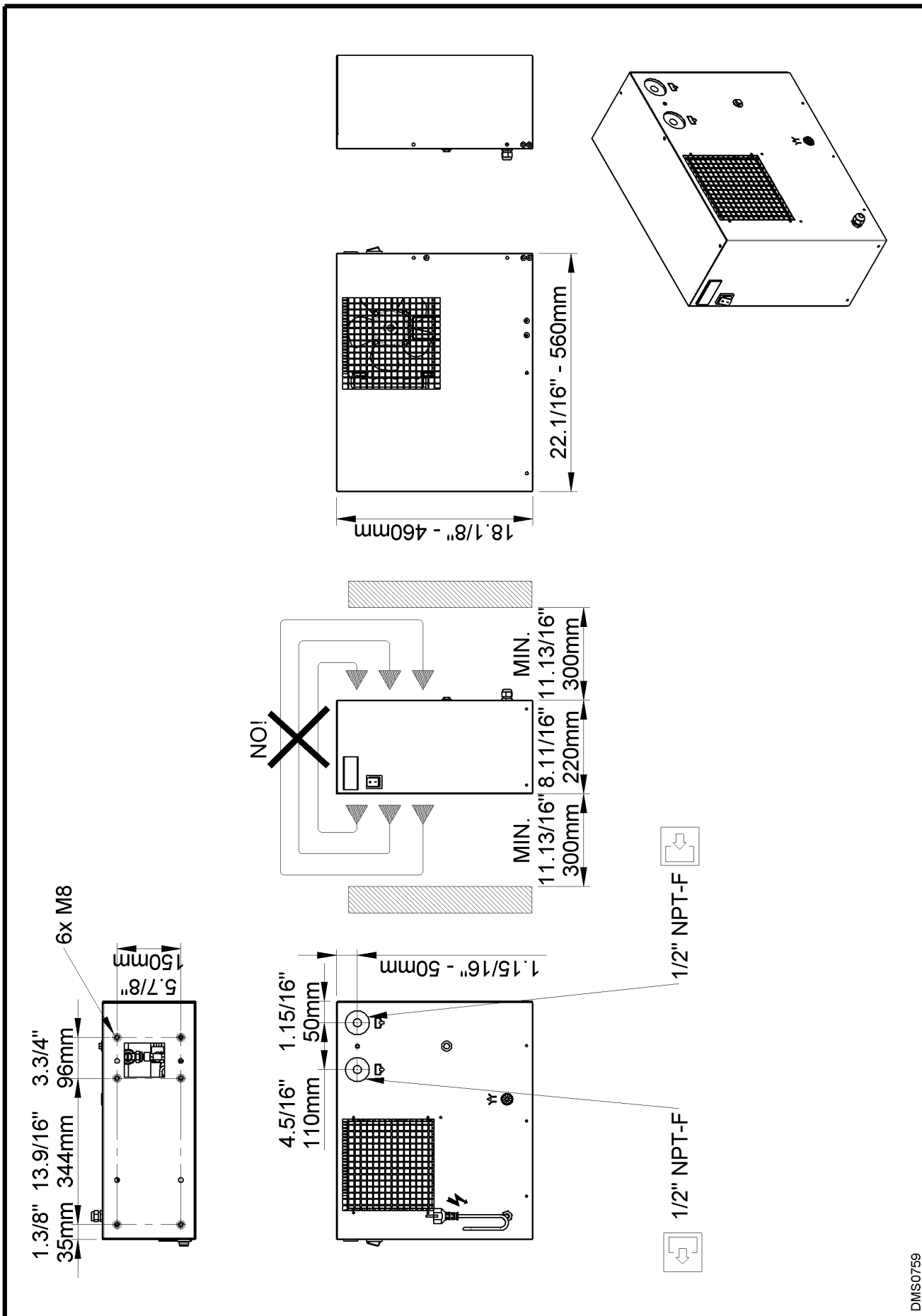

DMS0759

13.2 Dryer dimensions DRS 60-80

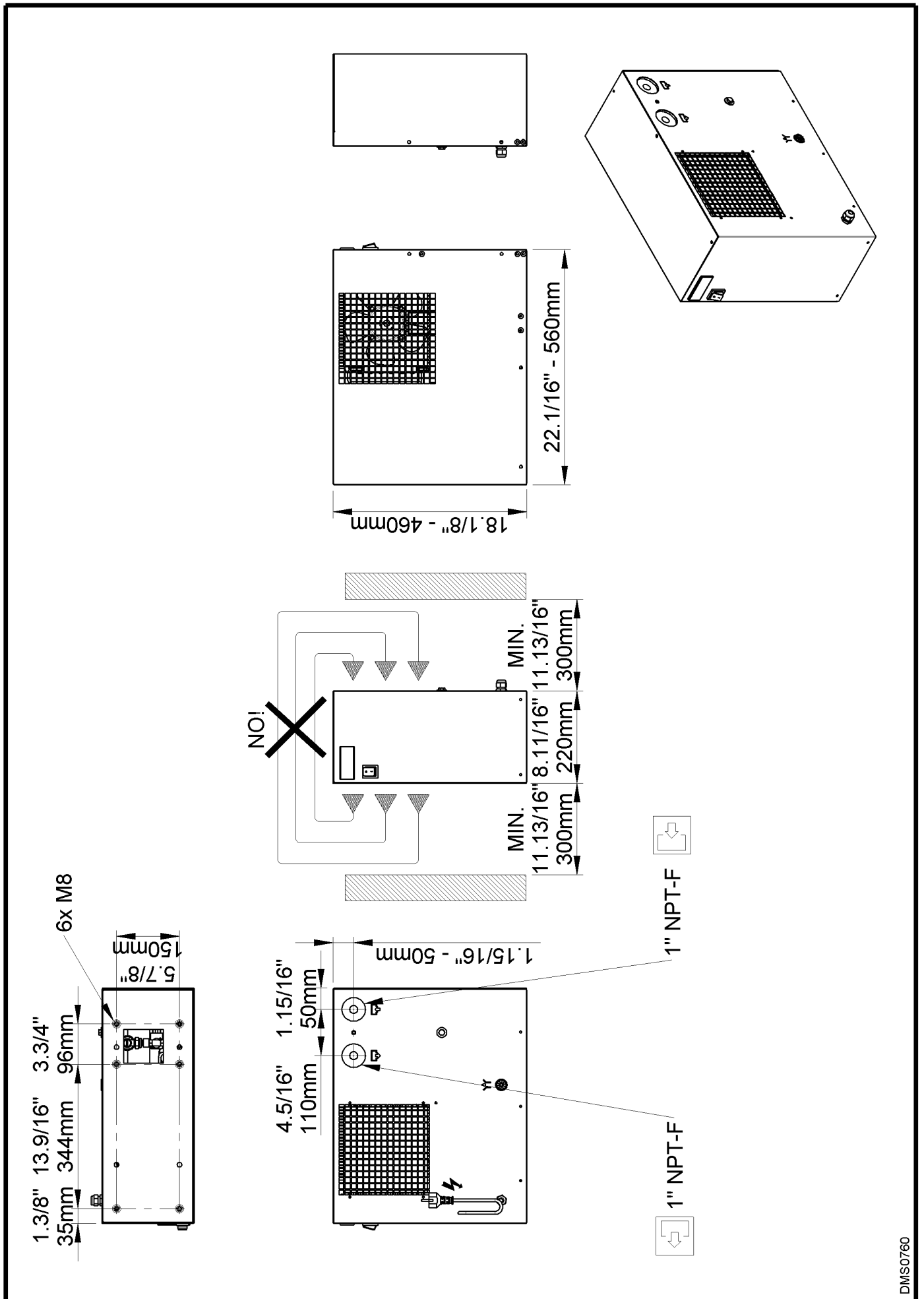

DMS0760

13.3 Dryer dimensions DRS 100

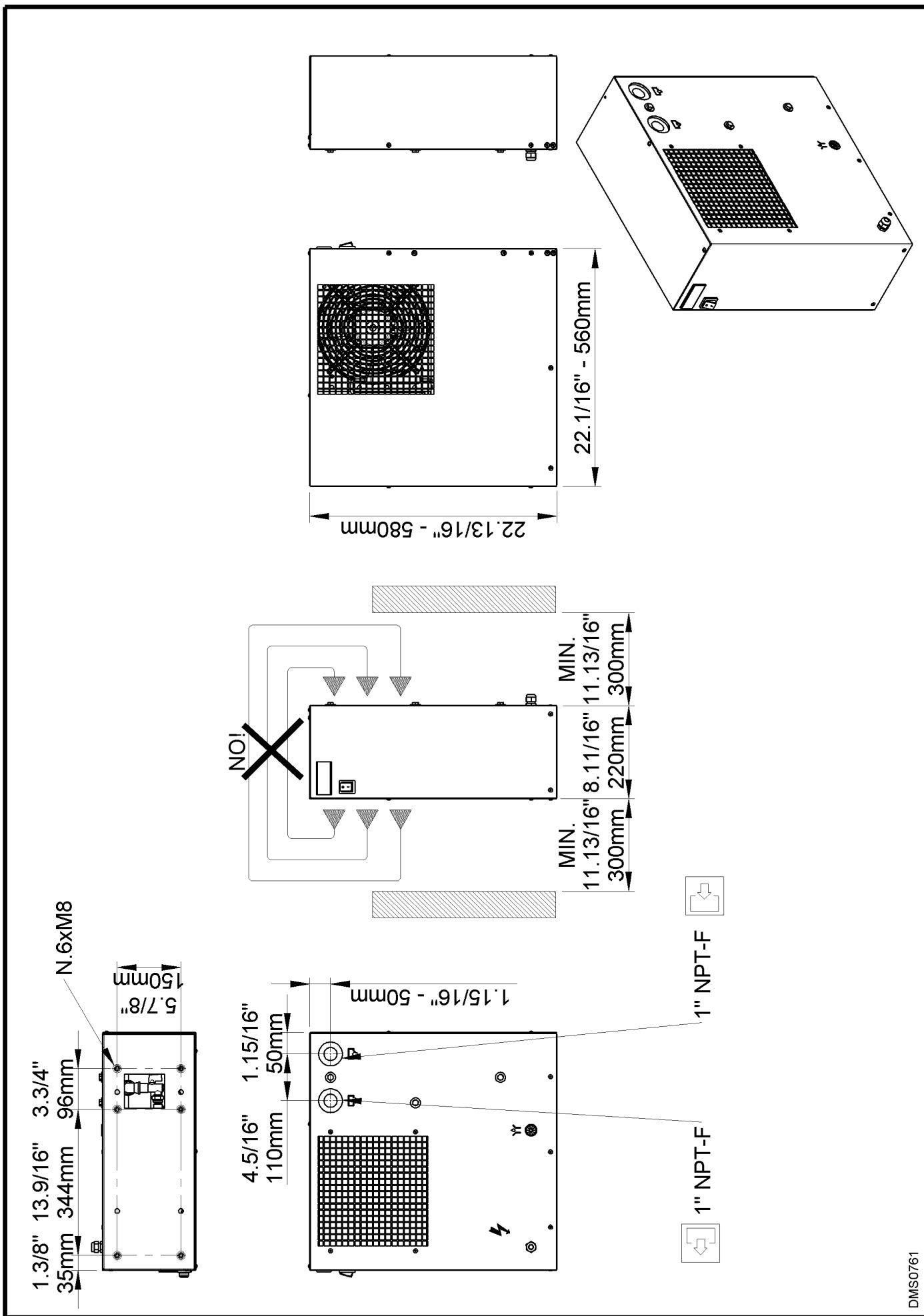

DMS0761

13.4 Dryer dimensions DRS 125

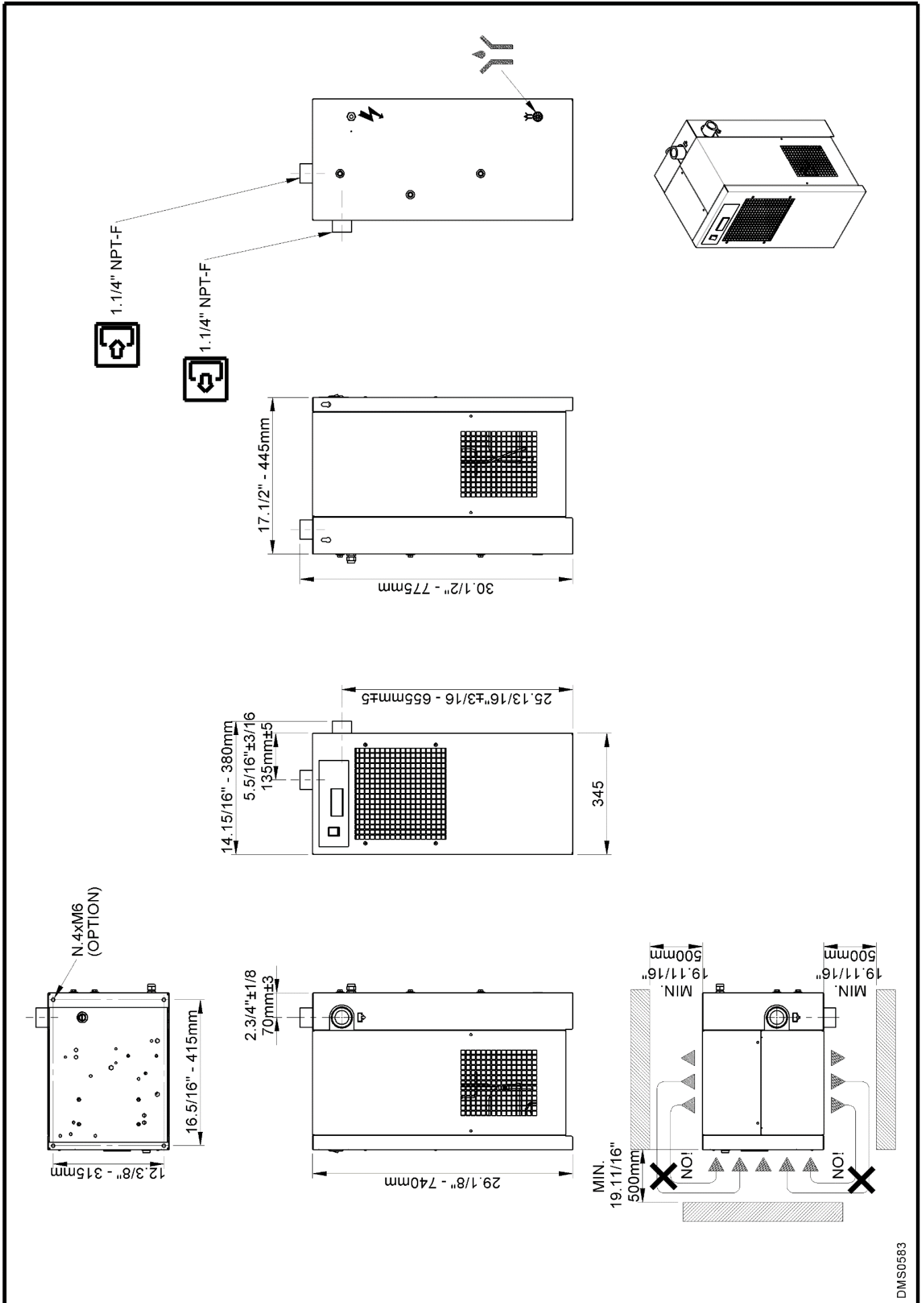

DMS0583

13.5 Exploded diagrams

13.5.1 Components of the exploded diagrams

- | | |
|--|--|
| 1 Alu drying module | 16 Coil for condensate drain solenoid valve |
| 1.1 Insulation material | 17 Air dryer control |
| 6 Compressor | 22 Main switch |
| 7 Hot-gas bypass valve | 37 Pressure transducer |
| 8 Condenser | 51 Front panel |
| 9 Condenser fan | 52 Back plate |
| 9.1 Motor | 53 Right sidewall |
| 9.2 Blade | 54 Left sidewall |
| 9.3 Grid | 55 Cover |
| 10 Filter dryer | 56 Base plate |
| 11 Capillary tube | 57 Upper plate |
| 12 T1 temperature probe (dew point) | 58 Carrier support |
| 13 Condensate drain service valve | 59 Support bracket |
| 14 Condensate drain strainer | 61 Electric connecting plug |
| 15 Condensate drain solenoid valve | |

13.5.2 Exploded diagram DRS 30-80

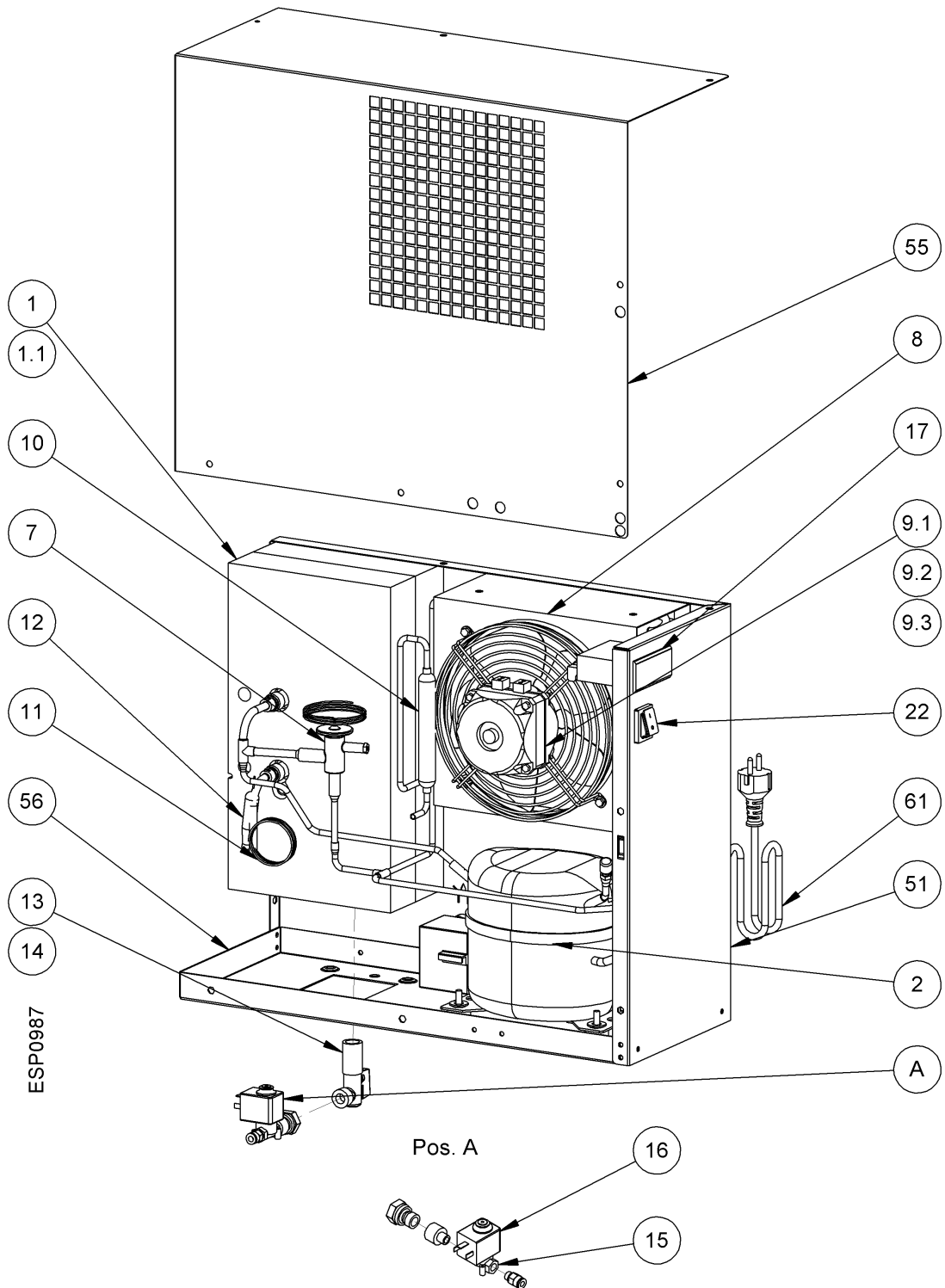

13.5.3 Exploded diagram DRS 100

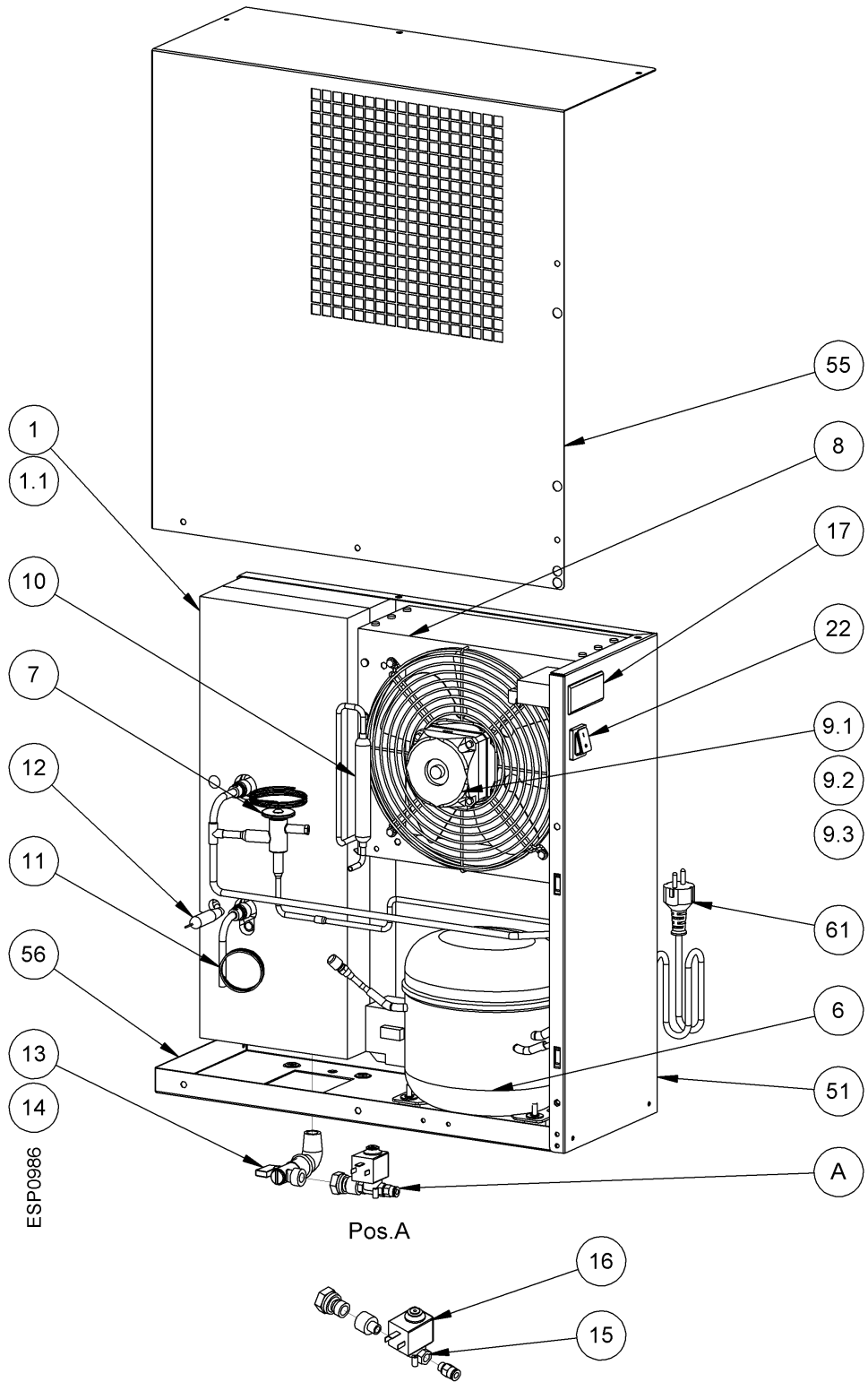

13.5.4 Exploded diagram DRS 125

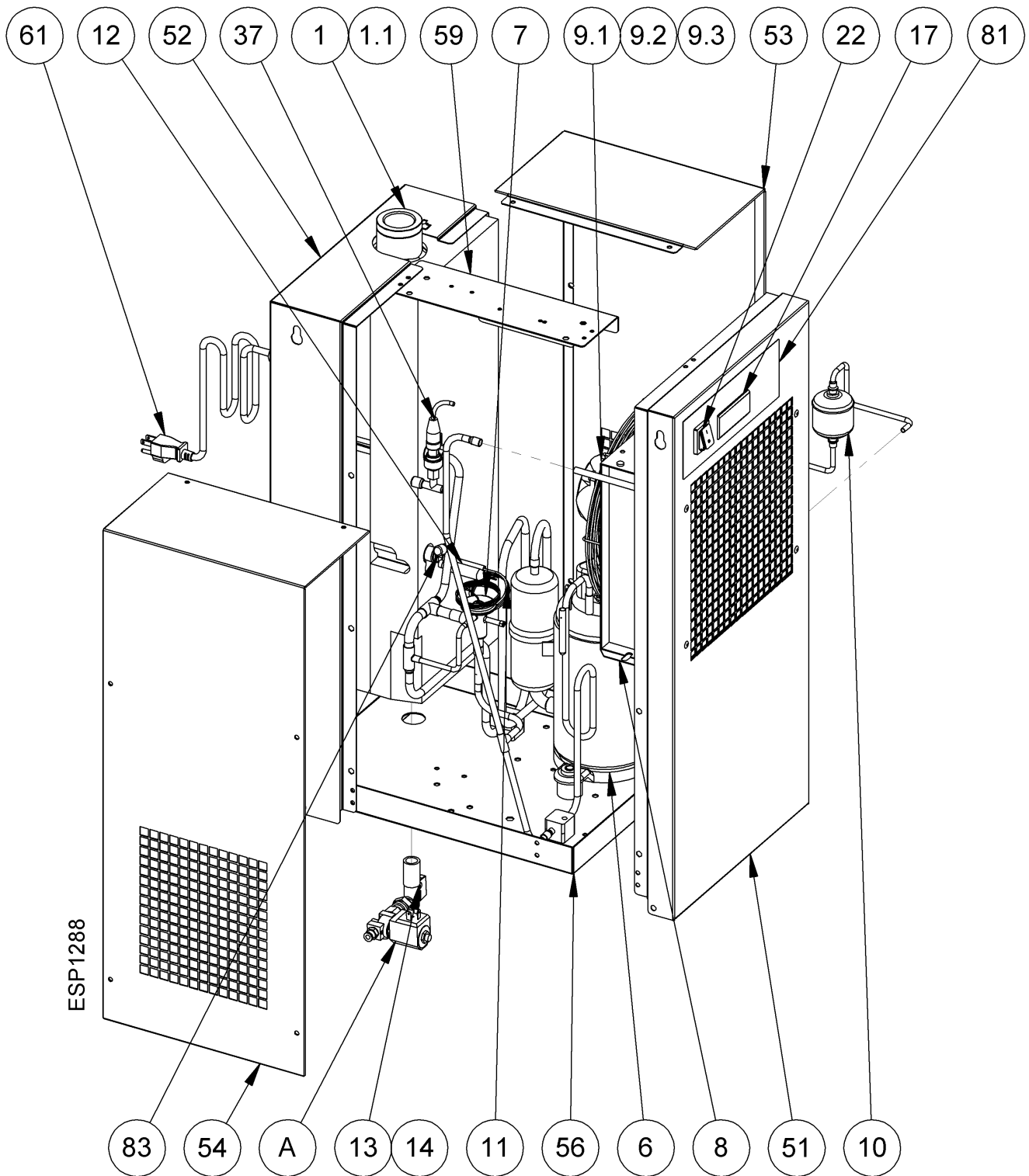

Pos.A

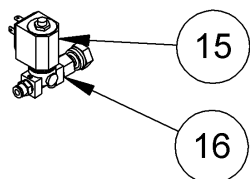

13.6 Electric diagrams

13.6.1 Electric diagrams – list of components

- MC** : Compressor
 - KT** : Compressor thermal protection
 - KR** : Compressor starting relay (if installed)
 - CS** : Compressor starting capacitor (if installed)
 - CR** : Compressor operating capacitor (if installed)
- MV** : Condenser fan
 - CV** : Fan starting capacitor (if installed)
- DMC35** : DMC35 electronic instrument – air dryer control
 - BT1** : T1 Temperature probe – dew point
 - BT2** : T2 Temperature probe – fan control
 - BP2** : P2 Pressure transducer – fan control
- S1** : ON/OFF switch
- NT1** : Only air-cooled
- NT2** : Check the transformer connections with regard to the supply voltage
- NT3** : Jump, if not installed
- NT4** : Provided and cabled by the customer
- NT5** : Internal control
- NT6** : Time-controlled drain outlet (not used)
- NT7** : Only water-cooled

- | | | | |
|-------------|--------------|----------------|-------------|
| BN = | BROWN | OR = | ORANGE |
| BU = | BLUE | RD = | RED |
| BK = | BLACK | WH = | WHITE |
| YG = | YELLOW/GREEN | WH/BK = | WHITE/BLACK |

13.6.2 Electric diagram DRS 30-100

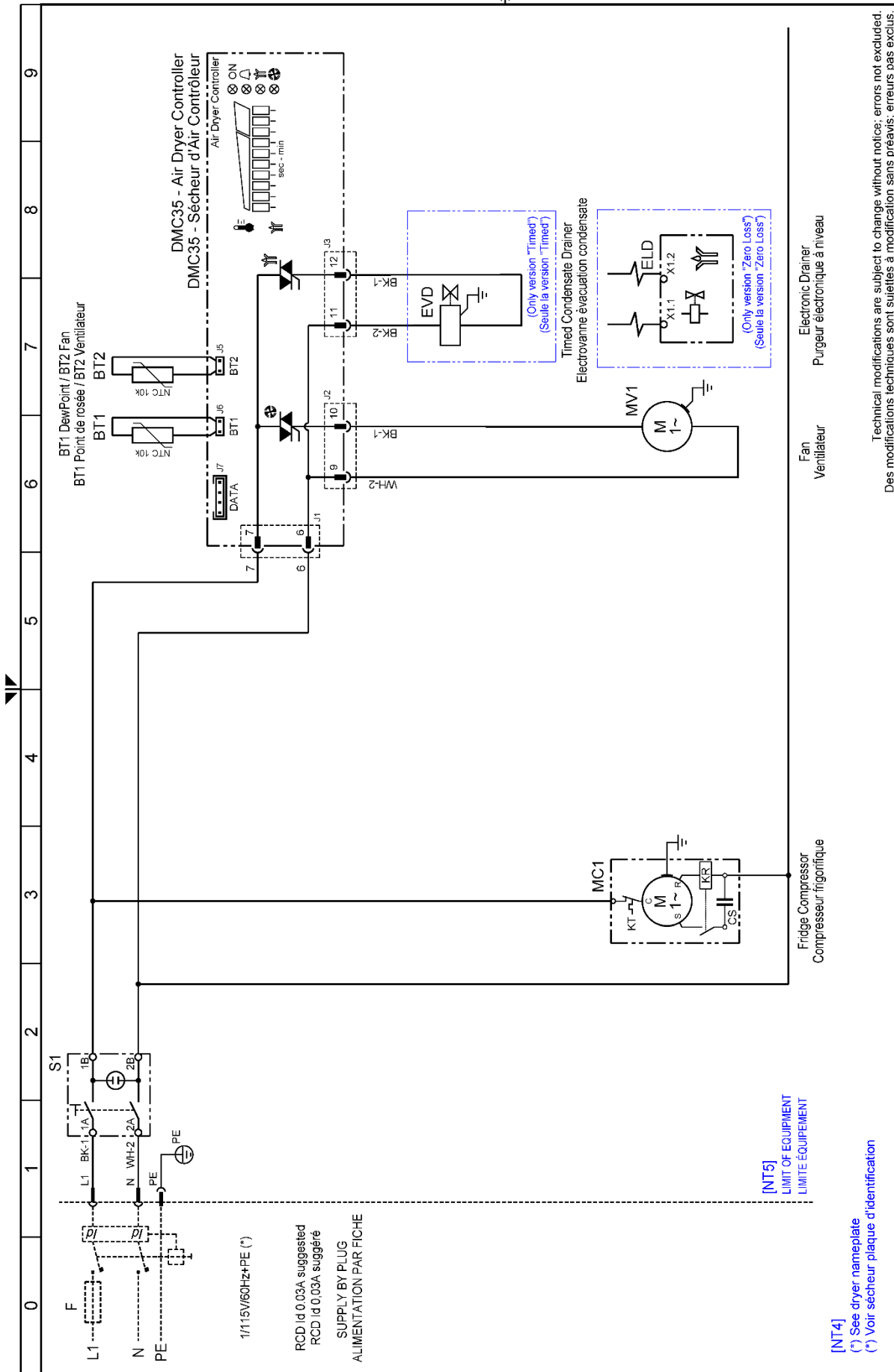

Technical modifications are subject to change without notices; errors not excluded.
Des modifications techniques sont sujettes à modification sans préavis; erreurs pas exclus.

Drawing no. / Numéro de dessin : WU001_V00

Notes / Remarque:

Rev. / Rev. 00

Sheet / feuille 01 of / de 01

13.6.3 Electric diagram DRS 125

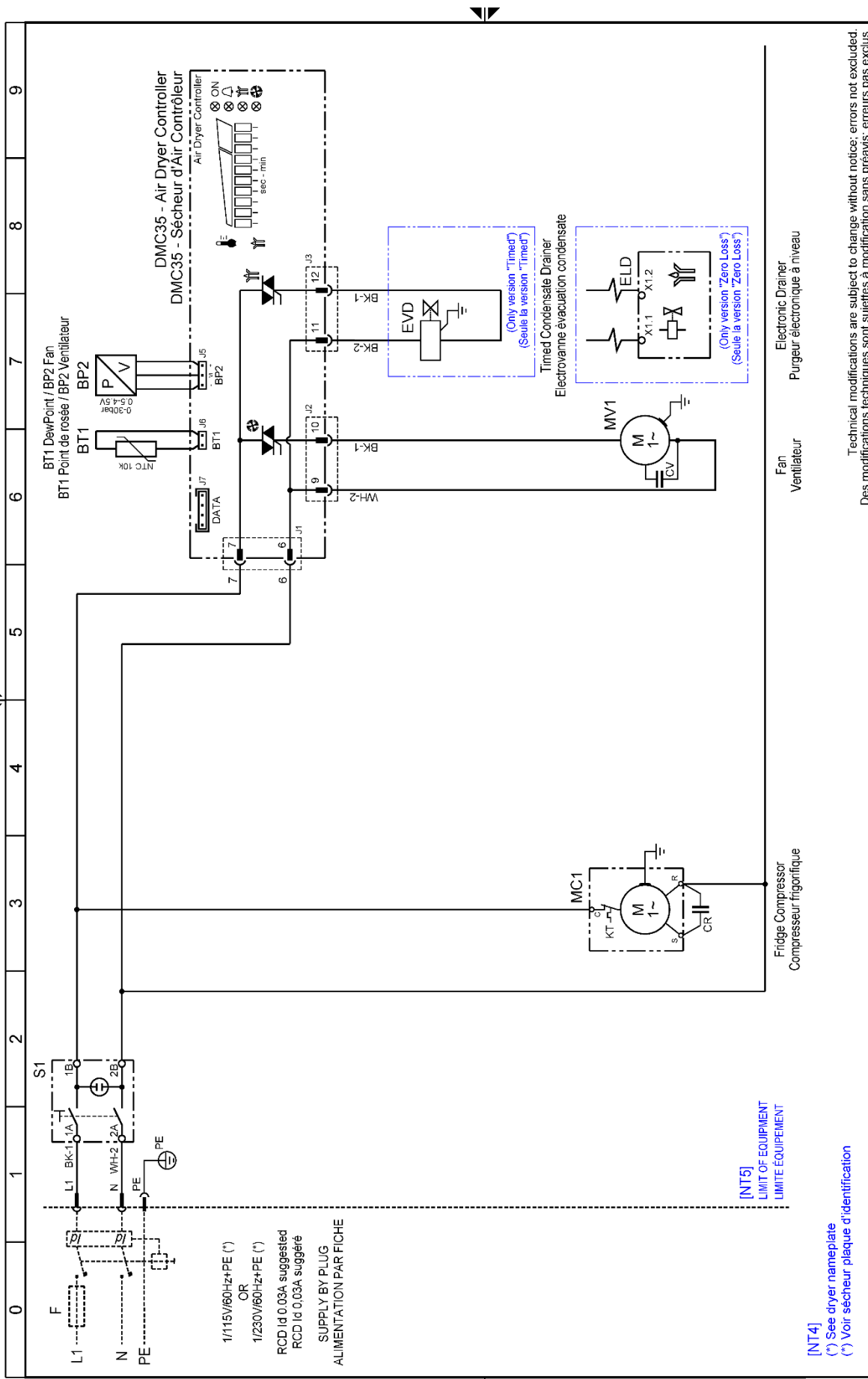

Technical modifications are subject to change without notice; errors not excluded.
Des modifications techniques sont sujettes à modification sans préavis; erreurs pas exclus.

Drawing no. / Numéro de dessin : WJ002_V00
Rev. / Rev. 00

Notes / Remarque:

Sheet / feuille 01 of / de 01

Contact Information

Kaishan, USA LLC
15445 Industrial Park Dr,
Loxely, AL, 36551
251.257.0586
www.KaishanUSA.com