

---

# **KRSD Series Rotary Screw Air Compressor**

---

## **Instruction Manual**

**(Controller MAM-200)**

---

---

PN: 96002018000001

Release: May 2018, Version: A

## TABLE OF CONTENTS

---

---

<b>1. Safety Information.....</b>	<b>4</b>
1.1 Safety Alert Symbols.....	4
1.2 Safety Precautions.....	5
1.3 Pressure.....	5
1.4 Fire and Explosion.....	6
1.5 Moving Parts.....	6
1.6 Hot Surfaces.....	6
1.7 Proper Compressed Air Applications.....	6
1.8 Electrical Shock.....	7
<b>2. General Information.....</b>	<b>8</b>
2.1 Introduction.....	8
2.2 The Compression Cycle.....	9
2.3 Compressor Lubrication and Cooling System.....	10
2.4 Compressor Discharge System.....	10
2.5 Air-end, Inlet Valve and Filtration System.....	11
<b>3. Fluid Information.....</b>	<b>12</b>
3.1 Fluid Guide.....	12
3.2 Fluid Change and Recommendations.....	13
<b>4. Installation.....</b>	<b>14</b>
4.1 Compressor Mounting, Support and Location.....	14
4.2 Ventilation and Cooling.....	14
4.3 Piping Connection.....	15
4.4 Fluid Level Inspection.....	16
4.5 Electrical.....	17
4.6 Motor Rotation Inspection.....	17
4.7 Fan Rotation Inspection .....	18
<b>5. Operation.....</b>	<b>19</b>
5.1 Routine Operation.....	19
5.2 Electronic controller basic operation.....	20
5.3 Technical Parameters and functions.....	29

**5.4 Model and specifications.....30**  
**5.5 Installation.....31**  
**5.6 Alarms.....34**  
**5.7 Controller protection.....35**  
**6. Servicing.....38**  
**6.1 Fluid Change.....38**  
**6.2 Air Filter.....38**  
**6.3 Fluid Filter.....39**  
**6.4 Air/Oil Separator.....39**  
**6.5 Fluid sampling procedure.....39**  
**6.6 Maintenance Schedule.....40**  
**7. Troubleshooting Guide.....42**  
**8. Standard Terms and Conditions .....45**

# Safety Information

---

Thank you for choosing Kaishan Compressor. Please read this instruction manual carefully before using the compressor. This manual must be kept in the safe place for future reference. Kaishan Compressor's authorized distributors provide maintenance service for KRSD series rotary screw compressors. A certified technician is required to ensure compressors maintenance is safely handled. By following the instructions in this manual, the user will minimize possibility of an accident throughout the useful life of this equipment.

## 1.1 SAFETY ALERT SYMBOLS

Key hazards are used throughout this manual. The level of hazards seriousness is symbolized as follows:



This symbol identifies immediate hazards which **will** result in severe personal injury, death or substantial property damage.



This symbol identifies hazards or unsafe practices which **could** result in personal injury, death or substantial property damage.



This symbol identifies immediate electrical hazards which **will** result in severe personal injury, death or substantial property damage.



This symbol identifies hazards or unsafe practices which **could** result in personal injury or substantial property damage.



This symbol identifies immediate hot surface hazards which **will** result in severe personal injury.



Identifies important installation, operation or maintenance information which is not hazard related.

## 1.2 SAFETY PRECAUTIONS

This manual describes the safety precautions, structure, and functions of all systems and components, as well as the operation and maintenance methods for the KRSD series rotary screw air compressors. The owner and operator shall read the manual carefully. Only after thorough understanding should the machine be operated for the first time. This manual gives you a general description of the mechanical and electrical systems and maintenance. However, if you have any questions about operating and maintenance of the compressor, please contact your authorized distributor or our service department personnel.

Do not modify the compressor and/or controls in any way except with written factory approval. While not specifically applicable to all types of compressors with all types of prime movers, most of the precautionary statements contained herein are applicable to most compressors and the concepts behind these statements are generally applicable to all compressors.



Failure to follow any of these precautions may result in severe personal injury, death, property damage and/or compressor damage

## 1.3 PRESSURE

A properly sized pressure relief valve must be installed in the discharge piping ahead (upstream) of any shutoff valve (block valve), heat exchanger, orifice, or any potential blockage point. Failure to install a pressure relief valve could result in the rupturing or explosion of some system components. Relieve all pressure internally to the compressor prior to servicing. Do not depend on check valves to hold system pressure. Do not change the pressure setting of the pressure relief valve, restrict the function of the pressure relief valve, or replace the pressure relief valve with a plug. Over pressurization of system or compressor components can occur resulting in death, severe personal injury, or property damage. Do not operate the compressor at pressures in excess of its rating. Never use plastic pipe, rubber hose, or soldered joints in any part of the compressed air system. Failure to ensure system compatibility with compressor piping is dangerous

## **1.4 FIRE AND EXPLOSION**

Clean up any spills of lubricant or combustible liquid immediately. Keep sparks and flame away from the compressor. Do not permit smoking during servicing, such as checking or adding fluid. Wipe down spills immediately using industrial cleaner as required. Do not use flammable material for cleaning purposes. Do not operate the compressor in a hazardous environment unless the compressor has been specially designed for that environment. Wear personal protective equipment including safety goggles and clothing during servicing the compressor. Never use a flammable or toxic solvent for cleaning the air filter or any parts.

## **1.5 MOVING PARTS**

Keep hands, arms and cloths away from the coupling and fans of the compressor. Do not remove any guards or cabinet panels or attempt to service any compressor part while the compressor is operating.

## **1.6 HOT SURFACES**

Do not touch any hot surface and parts during the compressor's operation. Keep all body parts away from air/oil receiver tank, steel tubing, air end and after-cooler. Wear personal protective equipment including gloves while servicing the compressor.

## **1.7 PROPER COMPRESSED AIR APPLICATIONS**

Air from this compressor will cause severe injury or death if used for breathing or food processing. Air used for those processes must meet OSHA and applicable industry regulations. This compressor is designed for use in the compression of normal atmospheric air only. No other gases, vapors or fumes should be exposed to the compressor intake, nor processed through the compressor. Keep personnel away from the compressed air discharge. Use compressed air for cleaning purpose only with effective chip guarding and personal protective equipment which meet OSHA standard and/or any federal, state, local codes, standard and regulation.

## 1.8 ELECTRICAL SHOCK

Never start the compressor unless it is safe to do so. Do not attempt to operate the compressor with a known unsafe condition. Tag the compressor and render it inoperative by disconnecting and locking out all power at the source or otherwise disabling its prime mover so others who may not know of the unsafe condition cannot attempt to operate it until the condition is corrected. Install, use and operate the compressor only in full compliance with all pertinent OSHA regulations and/or any applicable Federal, State, and Local codes, standards and regulations. Never assume it is safe to work on the compressor because it is not operating. Many installations have automatic start/stop controls and the compressor may start at any time.

- Follow all maintenance procedures and check all safety devices on schedule.



- Use the correct compressor fluid at all time

- Do not rely on the discharge check valve to isolate the compressed air service line

### NOTICE

- Keep panels closed at all times, and stay away from hot surfaces to prevent hazards



### NOTICE

These instructions, precautions and descriptions cover KRSD series air compressors. As a service to our customers, we often modify or construct packages to the customer's specifications. This manual may not be appropriate in those cases.

Every effort has been taken to ensure complete and correct instructions have been included in this manual. However, possible product updates and changes may have occurred since printing this manual. Kaishan Compressor USA reserves the right to change specifications without incurring any obligation for equipment previously or subsequently sold.

## General Information

---

### 2.1 INTRODUCTION

The KRSD series offer models with power ranging from 30 hp to 50 hp. These direct driven compressors have standard full load pressure rating from 100 psi to 175 psi (7 bar to 13 bar). The compressor is a single stage, positive displacement, fluid-flooded rotary screw. A complete package consists of following:

- Compressor (Air End)
- Electric motor
- Starter
- Air Inlet System
- Compressed air Discharge System
- Lubrication and Cooling System
- Capacity Control System
- Instrumentation Panel
- Air and Fluid Cooling System
- Air/ Fluid separation tank (Reservoir)

All components are assembled on a structural steel base with enclosure. The control panel is located in the front of the enclosure door panel. Acoustical enclosure is one of the standard features for all compressors.



Dismantling the compressor's enclosure may void its warranty.

**NOTICE!**



## 2.2 THE COMPRESSION CYCLE

The compressor housing contains of two rotors; Male and Female rotors. The male rotor has five lobes and female rotor has six flutes. They are constantly and precisely meshed, and housed in the cylinder with two parallel adjoining bores. All parts are machined to exacting tolerances. The rotors provide positive-displacement internal compression smoothly and without surging. As the rotors rotate, air is drawn into the cylinder through the inlet port. A volume of air is filled and trapped as the rotor lobes pass the inlet port in the cylinders. Compression occurs as the male rotor rolls into the female flute, progressively reducing the space thereby raising the pressure. Compression continues until the lobe and flute pass the discharge port. The compressed air is then discharged into the air/oil separator tank. There are five complete compression cycles for each complete rotation of the male rotor.

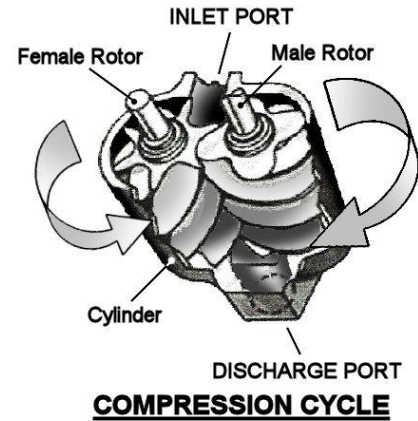

When the compressor is operating, a partial vacuum is produced at the compressor inlet. Fluid is injected into the compressor unit and mixed with the air. The fluid has three basic functions:

- As a coolant, it controls the rise in air temperature normally associated with the heat of compression.
- It seals the leakage paths between the rotors and stator and also between the rotors themselves.
- It acts as a lubricating film between the rotors allowing one rotor to directly drive the other, which is an idler.

After air/fluid mixture is discharged from compressor to the reservoir, fluid is separated from the air in the separator tank. Compressed air then flows through the after-cooler for moisture removal while the lubricant is being cooled by the fluid-cooler for re-injection.

## 2.3 COMPRESSOR LUBRICATION AND COOLING SYSTEM

The lubrication and cooling system consists of a reservoir, centrifugal fan, fan motor, aluminum finned fluid-cooler and after-cooler, thermal valve & fluid filter. High pressure forces the lubricant through a series of direction changes in the reservoir where it is separated from the air. The fluid is then delivered to the thermal valve and fluid-cooler. Cooled fluid will be filtered before being re-injected back into the compressor.

Ambient air is being forced through the cooler fins by the centrifugal fan, which cools the fluid and compressed air in the cooler tubes. The after-cooler helps separate the water content in the discharge air, and through the automatic condensate drain, the water will be drained. This avoids water contamination problems downstream (in service lines). Cooler fins must be kept clean at all times.

Fluid from reservoir circulates to the thermal valve. The thermal valve is fully closed when the fluid temperature is below 70°C (158°F). Fluid (below 158°F) will bypass the thermal valve and inject directly to the aircend. As the discharge temperature rises above 80°C (176°F), due to heat of compression, the thermal valve begins to open and fluid will be circulated to the cooler.

## 2.4 COMPRESSOR DISCHARGE SYSTEM

Air/fluid mixture has been forced into reservoir after compression. The reservoir has two basic functions:

- It acts as a primary fluid separator.
- It serves as the compressor fluid sump.

The compressed air/fluid mixture enters the reservoir and is directed against the internal baffle. Turbulent flow occurs, and velocity is significantly reduced, thus causing large droplets of fluid to form and fall to the bottom of reservoir. Fluid collected in the reservoir will then be returned to the compressor due to the pressure differential.

The sight glass enables the operator to visually monitor the reservoir fluid level. Fluid is added to the reservoir by removing the fluid filling cap after all system pressure is relieved. The fluid level should remain at the top red lines on the sight glass. Fluid refill is required once its level drops below the lower red line.

The minimum pressure check valve assures the reservoir maintains a minimum pressure between 58 psig and 72 psig (4Bar and 5Bar) during unloading conditions. This pressure is necessary for air/fluid separation and fluid circulation.

## 2.5 AIREND, INLETVALVE AND FILTRATION SYSTEM

The compressor inlet system consists of a air filter, inlet valve. & **SKK** airend. The inlet valve controls the air intake volume. It is also acts as the check valve to prevent the reverse pressure and rotation when compressor is shutting down.

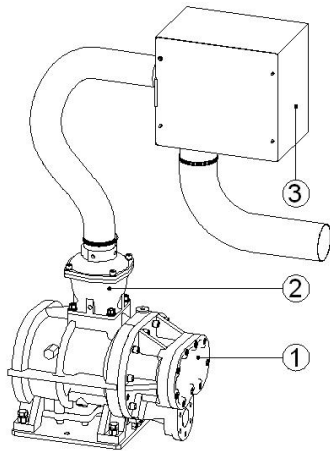

①	Air end
②	Inlet valve
③	Casing for air filter

## Fluid Information

---

### 3.1 FLUID GUIDE

KRSD compressors are filled & tested with Kaishan lubricant. Refer *Figure 3-1* for filler port, sight glass, quarter-turn valve location on the reservoir. The compressor is filled with the manufacturer's recommended quantity of Kaishan fluid. Inspection of the reservoir fluid level during installation or operation is recommended.

①	Air/Oil Separator Tank
②	Fluid Fill Port
③	Sight Glass
④	Fluid Drain Valve

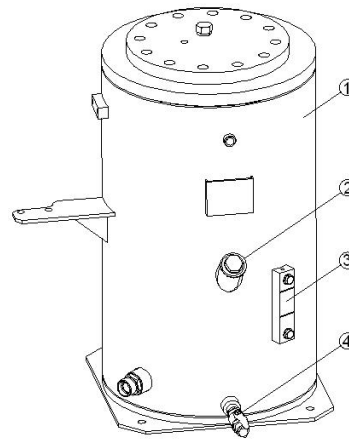

*Figure 3-1: Fluid Fill Location*



Do not use different fluid. Using different fluid will void compressor's warranty.

### 3.2 FLUID CHANGE RECOMMENDATIONS

LUBRICANT	FLUID CHANGE	FLUID FILTER CHANGE	SEPARATOR CHANGE
KTL8000	Every 8,000 hours or as indicated by sampling report	Every 2,000 hours or as indicated by Delta P	Every 8,000 hours (4,000 hours for "spin on" type separator) or as indicated by Delta P
KTL4000 FG	Every 4,000 hours or as indicated by sampling report	Every 2,000 hours or as indicated by Delta P	Every 8,000 hours (4,000 hours for "spin on" type separator) or as indicated by Delta P

# Installation

---

## 4.1 COMPRESSOR MOUNTING, SUPPORT AND LOCATION

Compressor should be located on a flat surface in a clean, well-lit and well-ventilated area. The location must have sufficient access for maintenance equipment and lifting vehicle. Four feet (4') of clearance around the compressor is recommended for daily inspection and easy access to all compressor components. The area must have sufficient lighting for technicians to safely operate the compressor as well as perform maintenance work. The location should be free from standing water.

The compressor's base must be installed on a level surface that can support the gross dead weight of the machine. Rubber pads with 5 - 15mm thickness or pliable material should be placed under the bottom of the base if floor surface is uneven or irregular. A stationary compressor will prevent accidents such as broken piping or electrical connections.



Brand new compressor has “Orange Color” shipping bracket installed under airend assembly. Please remove the bracket after the unit is installed.

### NOTICE!



Removal or paint over of safety labels will be a safety hazard. This could result in personal injury or property damage. Warning signs and labels should be conspicuous and on a bright legible surface. Do not remove any warning, caution or instructional material attached with unit.

## 4.2 VENTILATION AND COOLING

Ambient temperature should not exceed 40°C (104°F). High ambient temperatures may result in high air temperature shutdown.



**NOTICE!**

Do not install and operate compressor if the ambient temperature is below 2°C (35°F). Severe ambient modifications must be installed with the unit for lower ambient temperatures.

The compressor air inlet must be located in the opposite direction to other compressors or heat generating equipment. The object is to avoid hot air being drawn into the system. Do not block the exhaust air from cooler or fan. Hot exhaust air must be vented outside through a duct to prevent high ambient room temperature. The compressor room must be properly ventilated to avoid compressor high temperature shutdown.



Maintain clean & fresh air, dust free, metal particle free and chemical vapor free in the compressor's room. Housing the compressor within a poorly ventilated enclosure will cause higher operating temperature.



Under no circumstances should a compressor be installed in an area exposed to toxic, volatile or corrosive atmosphere, nor should toxic, volatile or corrosive agents be stored near the compressor.

All models are intended for indoor installation; however, it is possible, with certain modifications, to accommodate some outdoor locations. Models with standard enclosure are water-resistant but not water tight. Shelter is needed to protect the unit from rain, snow and freezing temperatures. An optional weather hood or air grille could be installed to protect compressor against blowing rain and snow as well as cabinet heater additions if ambient temperature will be below 2°C (35 F).

### 4.3 PIPING CONNECTION

Before installation, review the complete air systems layout, which includes compressor(s), receiver tank, dryer(s), line filter(s), pipe size, water drain and isolator valves. Never join pipes or fittings by soldering. Never use PVC pipe or non-genuine rubber hose in the air system. Use flexible connections to prevent pipe load from being transmitted to the compressor. Never use a different pipe size other than the manufacturer specification for the compressor unit.

A service line shut off valve must be installed after the compressor air outlet connection with a pressure relief valve installed to release compressed air to the atmosphere. For a single compressor and air receiver tank, manual shut off valves are typically being installed. A union connector must be installed after the ball valve (quarter turn, shut off valve) at the compressed air outlet. This will allow unit isolation for maintenance.



Make sure system pressure is relieved by confirming that sump pressure gauge is reading zero prior to servicing. Failure to relieve system pressure could result in death or serious injury and property damage.

A receiver tank should be installed if compressed air demands fluctuate. Service line piping is recommended to be sized to match the compressor's discharge connector. All piping & fittings should be rated to withstand greater pressure than the discharge pressure. Isolation valves & drain valves are installed to isolate the compressor when service is required. These valves should have water drip legs with the drain direction facing downward to the floor. Piping should all line up properly with an adequate loop radius or bend radius given for easy installation and to prevent bending stress, flow restriction and damage due to thermal expansion. Piping support brackets must be mounted independent of the compressor and motor. This will avoid damage caused by vibration.

Pressure relief valves are sized to protect the system. Never change the pressure setting or tamper with the valve. Only the valve manufacturer and their authorized representatives are allowed to make such changes.



Pressure relief valves are used to protect system integrity in accordance with safety standards. Failure to provide properly sized valves will result in death or serious injury.

Pressure relief valves are installed prior to any potential blockage point such as shutoff valves, heat exchangers and discharge silencers. Ideally, the valve should be threaded directly into the pressure point it is sensing, not connected with tubing or pipe. Always direct discharge from relief valves to a safe area away from personnel.

#### **4.4 FLUID LEVEL INSPECTION**

Inspect the fluid level when the compressor is in shut down mode. Fluid level is indicated on the reservoir sight glass. The maximum fluid level is at the top red-mark. Add fluid until the top red-mark is reached.



## 4.5 ELECTRICAL

Before installation, the electrical supply should be checked for adequate wire size and capacity. User must comply with national & local electrical codes. The codes specify the surrounding clearance requirement for the electrical panel. Wiring work should be undertaken only by a qualified electrician in compliance with OSHA, national or local electrical code. KRSD compressor includes wiring diagrams for user reference. Refer to the electrical control schematic in the parts manual for wiring diagrams. A dedicated and fused disconnect switch or circuit breaker should be purchased for the installation. Any unreasonable voltage imbalance (5%) between phases must be eliminated and low voltage problems must be corrected to prevent excessive current draw. Air compressors must be grounded in accordance with applicable codes, regulations and requirement.



Kaishan Compressor would like to emphasize the importance of providing adequate grounding for air compressors. The common practice of grounding units to a building's structural steel may not provide adequate grounding protection, as paint and corrosion build-up may exist.



All electrical supply cables must be adequately sized to prevent overheating due to current draw.



Enclosure panels and drive grille must be fastened in place before starting the compressor and never removed before lock out / tag out of the main power supply.

A knock out hole is provided for an incoming power connection. If a different location for the starter hole is needed, the certified technician must make sure to keep control box clean after the hole is created. The original hole must be capped if another hole is used. Inspect incoming voltage to match the compressor's specification. Inspect motor starter and overload heater sizes. Check electrical connections L1-L2-L3 for tightness and cleanliness.

## 4.6 MOTOR ROTATION INSPECTION

Motor rotation must be checked after the wiring has been installed. Operating the compressor in incorrect rotation will result in severe damage to the compressor and warranty coverage will be voided. Motor rotation can be viewed through the opening in the drive grille. The drive motor end of the compressor is marked with an arrow noting the proper rotation.

To inspect rotors rotation, pull out the “EMERGENCY STOP” button and press once, quickly press the “START” and “STOP” button in sequence, allowing the motor to turn 2 or 3 revolutions. Observe the drive shaft for correct direction. If reverse rotation is observed, disconnect the power supply, reverse power input leads at the motor starter. Recheck for proper rotation.

#### 4.7 FAN ROTATION INSPECTION

Fan motor rotation should be inspected. KRSD compressors use an axial fan for cooling. Fan rotation is inspected through an arrow shaped observation hole above the fan motor. The fan must rotate in the direction indicated by the arrow.



Always inspect fan rotation through the observation hole. Never assume the fan rotation is correct based on the induced air flow across the coolers. A centrifugal fan can pull the airflow across the coolers when rotating in either direction;

**NOTICE!** however, incorrect rotation will cause high discharge temperature.

# Operation

---

## 5.1 ROUTINE OPERATION



**CAUTION**

Provisions should be made to have the instruction manual readily available to the operator and maintenance personnel. If, for any reason, any parts of the manual become illegible or if the manual is lost, have it replaced immediately. The instruction manual should be read periodically to refresh one's memory. This may prevent a serious accident.

Before compressor start up, inspect fluid level in reservoir. After start up, observe the control panel screen for operation status. Ensure the compressor is running at its optimum level.

Close the service valve to plant air distribution system. Allow pressure to build up within the reservoir until compressor fully unloads. Press the stop button.



**NOTICE**

Always close the service valve when compressor is not being used. It prevents back pressure from the service line and avoids leakage due to check valve failure.



**NOTICE**

Emergency shutdown. Press the emergency stop button or pull the circuit breaker at the main power terminal.

# Operation

## 5.2. Electronic controller basic Operation

### 1. Keypad description

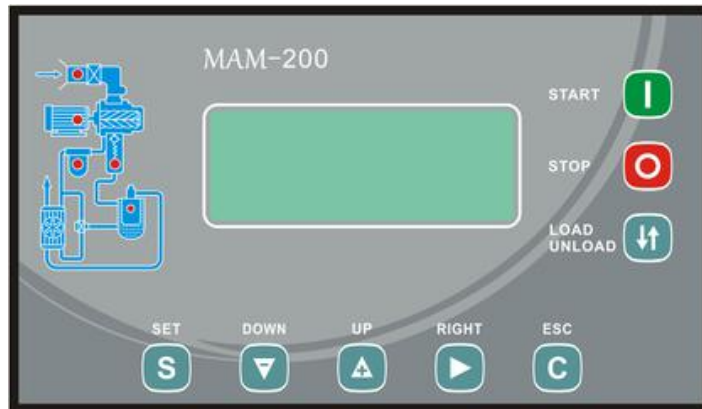

	<b>Start:</b> Press to start the compressor.
	<b>Stop:</b> Press to stop the compressor.
	<b>Manual Load / unload:</b> In the manual mode, press this button to load or unload.
	<b>Set:</b> After modification, press to confirm and save modified data. When entering a password, press to save and confirm the password.
	<b>Down / Decrease:</b> Data in current position is decreased by pressing this button when data is modified. Cursor is moved downwards when menu is selected.
	<b>Up / increase:</b> Data in current position is increased by pressing this button when data is modified. Cursor is moved upwards when menu is selected.
	<b>Right / Enter:</b> Moves the cursor when data is modified and is used as enter button when menu is selected.
	<b>Escape / Reset:</b> Serve as back button when in menu to return to the upper menu. Resetting is carried out by pressing this button for 5 seconds when in fault stop.

## 2. Status Display and Operation

The display will be as follows when the unit is powered on:

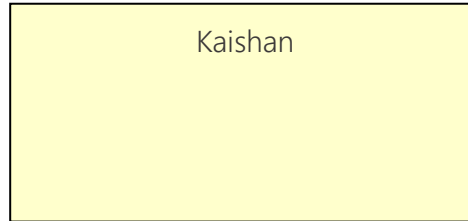

The main display will be as follows after 5 seconds:

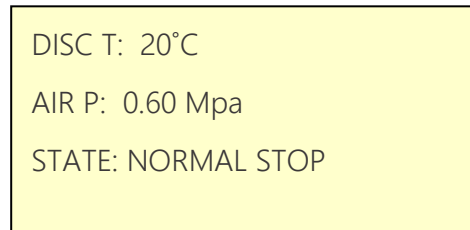

Press "Down" to enter into the following Menu Selection Interface:

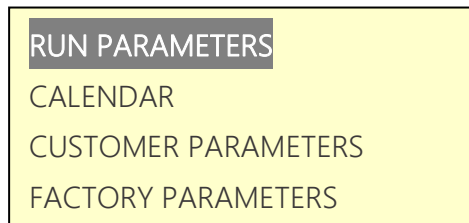

### a. Operation Parameters Review

Press "Up" or "Down" to move the black cursor to 'OPERATING PARAMETERS' and then press "Enter" to pop up the submenu:

```
MAIN, FAN CURR
TOTAL RUN TIME
THIS RUN TIME
MAINTENANCE PARA
```

Press "Enter" to pop up another menu:

```
CUR(A)  R    S    T
MAIN:  56.1 56.2 56.0
FAN:    4.1  4.1  4.1
```

If the current menu is in the last menu level, the black cursor will disappear. Press "Escape" and go back to the upper menu or the main menu. If the operation is stopped at a certain interface, it will automatically return to the main menu after a few seconds.

Use the "Up", "Down", "Enter" and "Escape" buttons to review the RUN PARAMETERS.

**b. Calendar and Time**

Press "Up" or "Down" to move the black cursor to the CALENDAR menu and press "Enter" to confirm, the following menu will be popped up:

```
DATE AND TIME
2017 Y 2 M 12 D
SUNDAY
12 H 46 M 59 S
```

When the motor is not running, the date and time can be adjusted according to the following steps:

Press “Up” or “Down” to move the black cursor to the line that you want to modify and then press “Enter”. Use “Right” to reach the position to modify and “Up” or “Down” buttons to modify data. Press “Set” to confirm and save the data after modification.

**c. Customer parameters**

**1) Parameter Modification**

NOTE: The Customer and Factory Preset Parameters cannot be modified during running and stop delay status.

The Customer Parameters can be read and modified with the same method of the running parameter review mentioned above. For example, to modify BLOCK LOAD PRESSURE, the steps will be as follows:

Press “Up” or “Down” to move the black cursor to the ‘CUSTOMER PARAMETER’ menu and then press “Enter” to pop up the following menu:

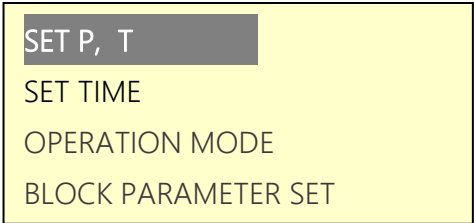

Press the “Enter” again to pop up the following menu:

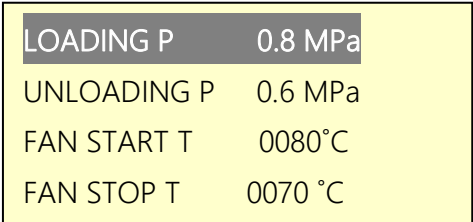

The CUSTOMER PARAMETERS can be read now without pressing “Enter”. When pressing “Enter” the following interface will pop up and the password will be required (9999).

NOTE: Customer Password can be modified in the CUSTOMER PARAMETER menu.

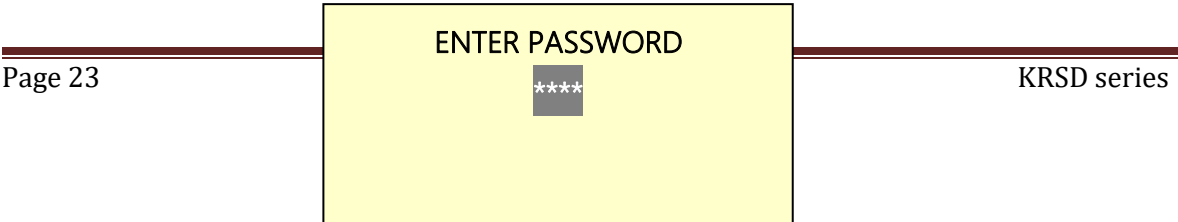

The black cursor will blink after this interface has popped up. The “Up” and “Down” buttons can be used to change the current value. The “Right” button is used to move the position to where the modification is needed. Press “Set” to confirm and the interface will be as follows:

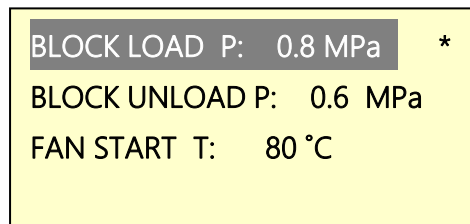

The \* in the upper right corner indicates that you are in a setting status.

The “Up” and “Down” buttons return to be the black cursor moving buttons and the “Right” button returns to be the “Enter” button.

Press the “Enter” button when the cursor is over the PRESSURE UPPER LIMIT menu, now the blinking cursor appears and the “Up” and “Down” buttons can be used to change the current value. The “Right” button can be used to move the position to where the modification is needed, Press “Set” to confirm and the blinking cursor will disappear.

The other CUSTOMER PARAMETERS can be modified using the same procedure.

## 2) Customer parameters and functions

FIRST SUBMENU	SECOND SUBMENU	PRESET VALUE	FUNCTION
SET P. T.	PRESSURE UNITS	PSIG/MPa/BAR	Set the pressure units.
	TEMPERATURE UNITS	°C/°F	Set the temperature units for °C or °F
	LOAD P.	*.**MPa	Load pressure setting.
	UNLOAD P.	*.**Mpa	Unload pressure setting.
	FAN START T.	*** °C	Fan will start if discharge temperature is above this setting. This value will be set as “120 °C (248 °F)” if there is no fan



			present or the fan is not required to be protected.
	FAN STOP T.	*** °C	Fan will stop if discharge temperature is bellow this setting.
ON/OFF DELAY TIME PRE-SET	MOTOR START	0008S	When using the controller to protect the motor, is set to bypass the motor overload protection on start up. It is required that the time set here will not meet the impulse starting current of the motor, the value here must be longer than the STAR DELAY TIME plus LOAD DELAY TIME
	FAN START	0006S	When using the controller to protect the fan motor, it is set to bypass the fan motor overload protection on start up. It is required that the time set here will not meet the impulse starting current of the motor.
	STAR DELAY	0006S	Star-delta changeover time.
	LOAD DELAY	0002S	Delay to load when running in delta.
	EMPTY DELAY	0020M	When running continuously unloaded, the machine will automatically stop after this time.
	STOP DELAY	0010S	Run on time after the "Stop" button has been pressed.
	START DELAY	0100S	Machine cannot be restarted before this set time after stopped or over time operation unloaded.
	STANDBY DELAY TIME	0000S	Additional functions.
	DRAIN OPEN TIME	0002S	Continuous draining time during the automatic draining control.

	DRAIN CLOSE TIME	0010M	Draining interval time by automatic draining control.
OPERATION MODE PRESET	ON/OFF MODE	MACHINE SIDE	When the remote mode is set, both the button on the controller and the remote control button can turn on and off the machine.
	LOAD MODE	AUTO	When the manual mode is set, the Load/Unload function can only be executed by pressing the "Loading/Unloading" button
	COM MODE	PROHIBITED	When this is set as 'PROHIBIT' the communication function is not available.
	COM CODE	0255	Communication address.
BLOCK PARAMETER PRESET	BLOCK MODE	Host	Act as Host or slave when there are more than one machine running in blocking mode. The HOST controls the SLAVES.
	BLOCK ON/OFF	Sequence	
	SEQUENCE TIME	9999 Hours	
	BLOCK NUMBER	0016	
	BLOCK LOAD P	*.**MPa	
	BLOCK UNLOAD P	*.**MPa	
	BLOCK DELAY TIME	0000S	
MAINTENANCE PARAMETER RESET	OIL FILTER RESET	0000H	Reset the running time of the oil filter.
	O/A FILTER RESET	0000H	Reset the running time of the O/A Separator.
	AIR FILTER RESET	0000H	Reset the running time of the air filter.
	LUBE OIL RESET	0000H	Reset the running time of the Lubrication Oil.

	LUB GREASE RESET	0000H	Reset the running time of the Lubrication Grease.
	HI TEMP ALARM	0105	When discharge temperature reaches this set value, compressor will alarm.
	HI TEMP TRIP	0110	When the discharge temperature reaches this set value, compressor will alarm and stop.
MAX. LIFE TIME PRESET	OIL FILTER	9999H	Set the time for the oil filter alarm function. Set to "0" to disable.
	O/A SEPARATOR	9999H	Set the time for the O/A separator alarm function. Set to "0" to disable.
	AIR FILTER	9999H	Set the time for the air filter alarm function. Set to "0" to disable.
	LUB OIL	9999H	Set the time for the lubrication oil alarm function. Set to "0" to disable.
	LUB GREASE	9999H	Set the time for the lubrication grease alarm function. Set to "0" to disable.
LANGUAGE DISPLAY	EN/CH	EN	Set this value to "EN" for English. Set this value to "CH" for Chinese.
USER PASSWORD MODIFICATION		****	Customer can modify the user password.

**d) Factory parameters**

The FACTORY PARAMETERS cannot be modified unless you have the manufacturer password

Modification procedure for the FACTORY PARAMETERS is the same as for the CUSTOMER PARAMETERS.

PARAMETER	PRESET VALUE	FUNCTION
MOTOR RATED CURRENT	Maximum allowable overload current of the main motor /1.2	After the starting delay time, when the motor current is greater than 1.2 times of the set value and less than 4 times of the set value, an overload will be detected.
FAN RATED CURRENT	Maximum allowable overload current of the fan motor /1.2	Same as above.
PRE-ALARM T.	105°C (221°F)	Pre-alarm when the temperature reaches this set value.
STOP T.	110°C (230 °F)	Alarm and stop the machine when the air discharge temperature reaches this set value.
STOP P.	1.00MPa (145 Psi)	Alarm and stop the machine when the air pressure reaches this set value.
UNLOAD P. UPPER LIMIT	00.80MPa (116 Psi)	The unload pressure in the User Parameters must be set lower than this value.
MODI LOAD TIME	*****H	The manufacturer can modify the total load time.
MODI TOTAL TIME	*****H	The manufacturer can modify the total running time.
HISTORY FAULT RESET	****	Enter the fault history password to clear the fault history.
UNBALANCE SCOPE	0006	When (max. phase current / min. phase current) is greater than (1 + set value), the unbalance protection will stop the machine. If the set value is greater than 15, the unbalance protection will be disabled.
LACK PHASE PROTECTION	005.0S	If set time of phase loss $\geq 20$ seconds, phase loss protection function is disabled; If unbalance protection is activated, it will stop operation.
MAX RUN TIME	0000M	When compressor is in stop status and the total run time is above this setting, compressor will alarm and report "User mistake".
PRODUCE DATE	****Y**M**D	Manufacturing date of the unit.
PRODUCE No.	*****	Serial number of the unit.
VOLTAGE LIMIT HIGH	****V	If voltage is higher than the set value, the shutdown protection will be activated, reporting voltage is too high. If this value is set to 0000, the high voltage function is disabled.
VOLTAGE LIMIT LOW	****V	If voltage is lower than the set value, the shutdown protection will be activated, reporting voltage is too low. If this value is set to 0000, the low voltage function is disabled.
FREQ SEL	60H	Set the power frequency.
ALARM STOP DELAY	0000H	If the Warning time for oil filter, air filter, separator. Lubricant or grease is over this setting, compressor reports "warning too long" and stops.

INTERFACE	NEUTRAL	
LOW TEMP PROTECT	-020°C (-4 °F)	If temperature is lower than the set value, the compressor will not start, reporting temperature is too low.
START PASSWORD	0000	The controller will start the compressor only by entering this password. When set to 0000 no password is required.

### 5.3. Technical Parameters and functions

1. Digital input/output: 9 Digital inputs; 10 digital relay outputs.;
2. Analog inputs: (2) PT100 temperature sensor inputs, (2) 4~20mA; two groups of three phase current inputs (CT);
3. Input voltage: three phase, 460V/220V;
4. Controller power supply: 220V, 50/60Hz, 12VS (20VA recommended) ;
5. Measurement range displayed:
  - Oil temperature: -20~150°C (-58~302°F); accuracy: ±1°C.
  - Air temperature: -20~150°C (-58~302°F); accuracy: ±1°C.
  - Running time: 0~999999 hours.
  - Current: 0~999.9 A.
  - Pressure: 0~1.60MPa (0~232 Psi). Accuracy: 0.01Mpa.
6. Phase-sequence protection: Response time ≤2s.
7. Motor protection: This controller has five basic protection functions for main and fan motors:
  - Block protection: When current reaches from 4 to 8 times the set current after finishing starting, response time ≤0.2s.
  - Short circuit protection: When current reaches above 8 times the set current, response time ≤0.2s.
  - Phase loss protection: In case of any phase loss, operation time equals set time.
  - Unbalance protection: When current difference of any two phase reach the set value, operation time equals set time.
  - Overload protection: Operates with a time delay according to overload factors and operation time shown in the following table:

I actual / I set	≥1.2	≥1.3	≥1.5	≥1.6	≥2.0	≥3.0
Operation time (s)	60	48	24	8	5	1

8. Temperature protection: When actual temperature is higher than set temperature; response time ≤2s.

9. Contact capacity of output relays: 250V, 5A; contact duration 500000 times;

10. Error of displayed current is less than 1.0%;

11. RS485 communication.

#### 5.4. Model and specifications

##### 1. Model description

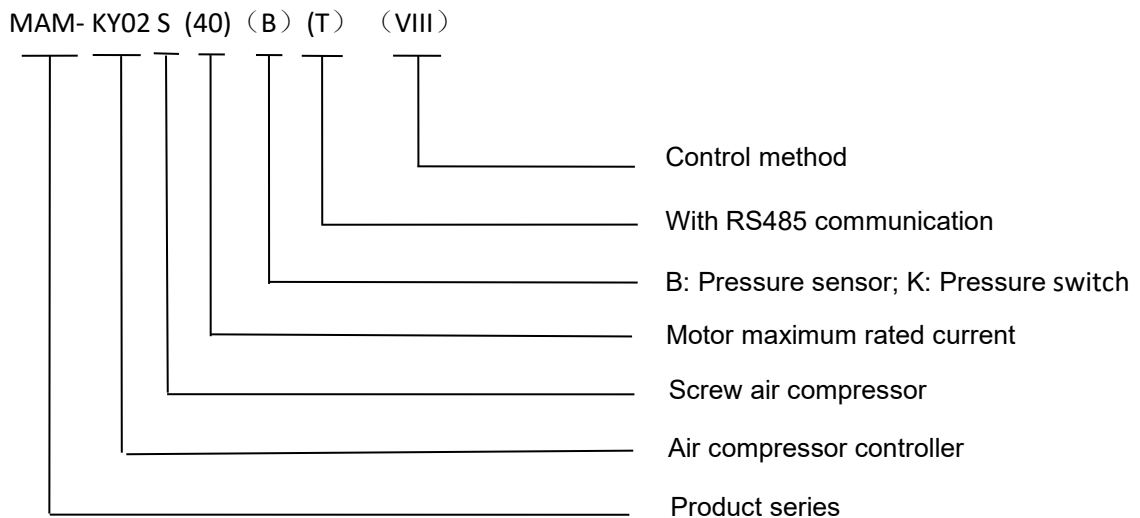

## 2. Specification table for motor power

MODEL	Current range (A)	Suited main motor power (KW)	Remark	Description
MAM-KY02S (20)	8~20	4~10		Fan has three current levels, 0.2-2.5A, 1-5A and 4-10A, determined according to fan's current
MAM-KY02S (40)	16~40	8~20		
MAM-KY02S (100)	30~100	15~50		
MAM-KY02S (200)	80~200	40~100		
MAM-KY02S (400)	160~400	80~200		
MAM-KY02S (600/5)	100~600	50~300	Connect to CT	

### 5.5. Installation

#### 1. CT's Installation

Transducers shall be installed where motor line current (rated current) can be measured, thus controller can be set according to data in motor's name plate, the detailed dimensions are as follows:

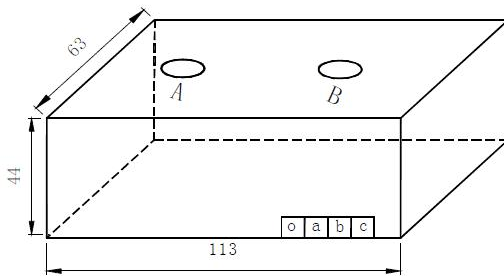

Figure 2. Dimensions of CT1 ( $\phi 36$  through hole).

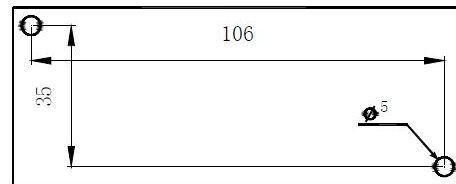

Figure 3. Installation dimensions of CT1.

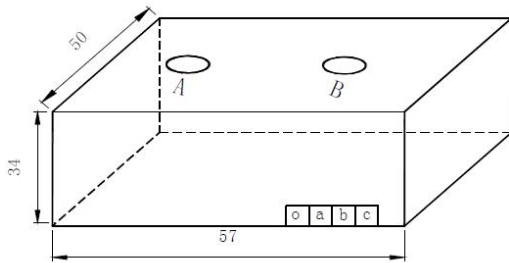

Figure 4. Dimensions of CT2 ( $\phi 10$  through hole).

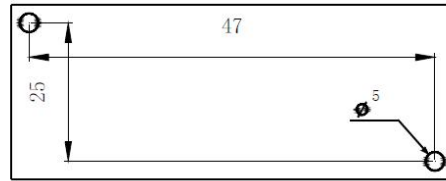
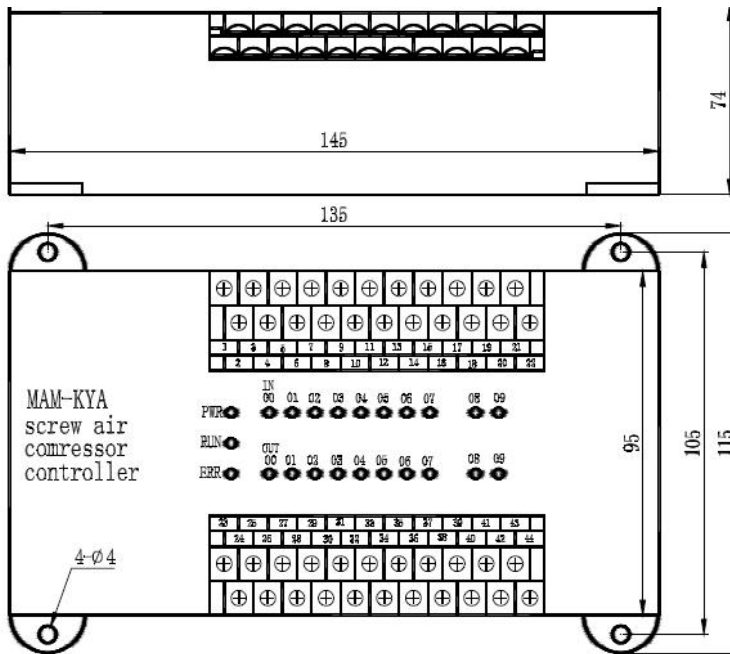

Figure 5. Installation dimensions of CT2.

## 2. Controller Installation

Room should be left around controller for wiring. The specific dimensions are as follows:



Input LED (IN) 00, 01, 02, 03, 04, 05, 06 and 07 correspond to the input switching value of terminals 20, 19, 18, 17, 16, 15, 14 and 13.

Output LED (OUT) 00, 01, 02, 03, 04, 05, 06, 07, 08 and 09 correspond to the output switching value of terminals 27, 28, 29, 30, 31, 35, 36, 37, 38 and 39.

PWR: Power indicator

RUN: Run indicator

ERR: Error indicator



### 3. Control panel installation

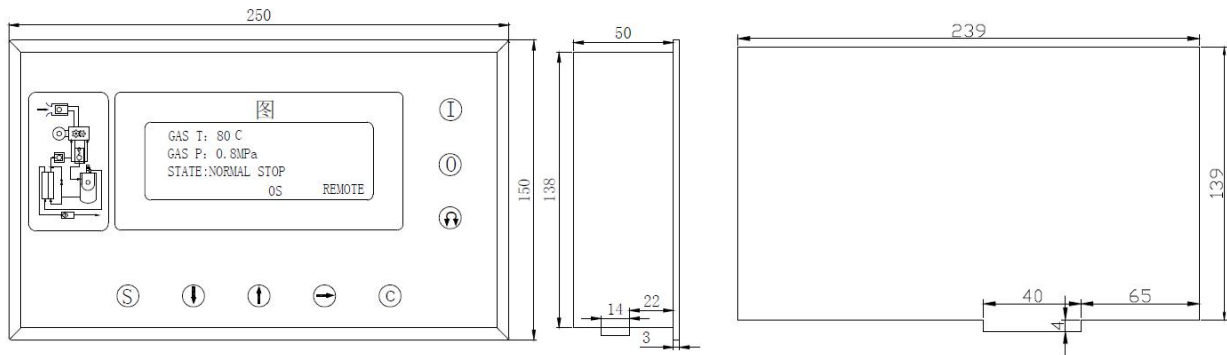
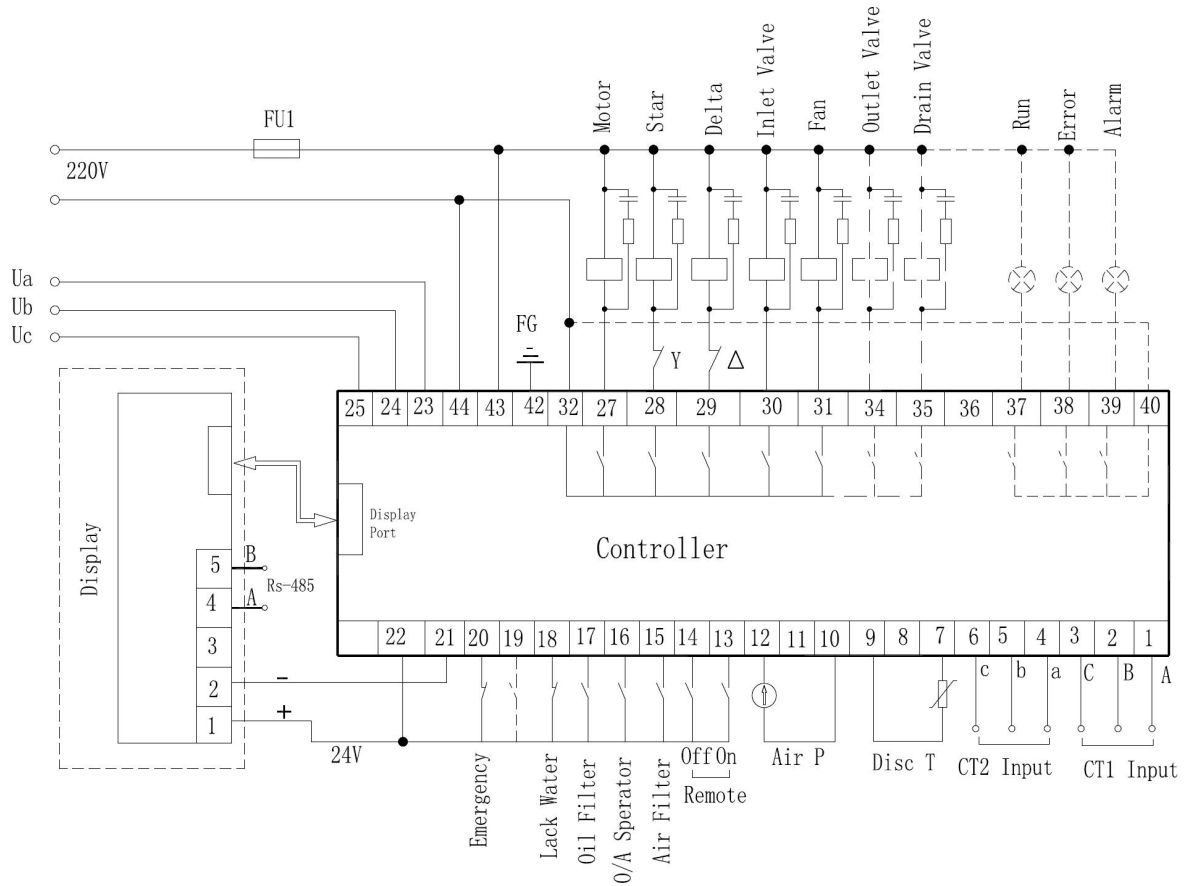

Figure7. Control panel dimensions.

### 3. Terminal arrangement schematic

TERMINAL	FUNCTION	TERMINAL	FUNCTION
1, 2, 3	Main motor CT1	31	Fan control
4, 5, 6	Fan motor CT2	34	Outlet valve
7, 9	Temperature sensor signal	37	Run indicator
23, 24, 25	Phase input	38	Error indicator
27	Main motor contactor	39	Alarm indicator
28	Star contactor	40	Communication port 2
29	Delta contactor	42	Ground (analog)
30	Inlet valve	43, 44	220 V



There are five connection cables and one communication cable which are used for display connection, RS-485 communication and 24V power supply.

NOTE: Electromagnetism coil shall be connected with surge absorber during wiring.

## **5.6. Alarms.**

### **1. Air filter alarm.**

- a. Air filter blocked. The panel displays AIR BLOCK when pressure differential switch closes.
- b. Air filter running time alarm. Displays “AIR TIME END” when the running time of the air filter terminates.

### **2. Oil filter alarm.**

- a. Oil filter blocked. The panel displays OIL BLOCK when pressure differential switch closes.
- b. Oil filter running time alarm. Displays “OIL TIME END” when the running time of the oil filter terminates.

### **3. O/A separator alarm.**

- a. O/A separator blocked. The panel displays O/A BLOCK when pressure differential switch closes.
- b. O/A running time alarm. Displays “O/A TIME END” when the running time of the oil separator terminates.

### **4. Lubricant oil alarm.**

Displays “LUBE TIME END” when the running time of the lubricant oil terminates.

### **5. Grease alarm.**

Displays “GREASE TIME END” when the running time of the grease terminates.

### **6. High discharge temperature alarm.**

Displays “DISC T HIGH” when the discharge temperature is higher than the ALARM DISC T set in the FACTORY PARAMETERS menu.

## **5.7. Controller protection**

### **1. Motor protection**

The air compressor controller provides protection functions for short-circuit, blocking, phase fault, overload and phase imbalance.

<b>Fault</b>	<b>Fault Display</b>	<b>Probable Cause</b>
Short circuit	“MOTOR/FAN OVERLOAD”	Short circuit or rated current has not been set correctly.
Blocked	“MOTOR/FAN BLOCK”	Too much load, bearing wear or other mechanical problem.
Overload	“MOTOR/FAN OVERLOAD”	Too much load, bearing wear or other mechanical problem.
Phase loss	“MOTOR/FAN LACK PHASE”	Power supply, contactor or motor phase loss.
Unbalance	“MOTOR/FAN UNBLANCE”	Poor contact of contactor, internal open-loop of motor.

## **2. Discharge air high temperature protection.**

When the Air discharge temperature is higher than the set temperature, the controller will stop the compressor. The display will show “**DISC T HIGHT**”.

## **3. Anti-reversing protection.**

When the three-phase power supply sequence connected to the air compressor is not the same of that set for the controller, the fault is displayed as “**PHASE WRONG1**”, as a result, the controller cannot start the compressor. Change any arbitrary two-phase power lines and check the rotation of the motor.

## **4. Overpressure protection.**

When the discharge air pressure is higher than the set pressure, the controller will stop the compressor. The fault is displayed as “**HIGH P**”.

## **5. Sensor malfunction protection.**

When pressure sensor or temperature sensor is disconnected, the controller cannot start the compressor. The fault is displayed as “**\*\*\*SENSOR FAULT**”.

## **6. Open phase protection.**

When an open phase is detected, the controller cannot start the compressor. The fault is displayed as “**PHASE WRONG2**”.

## VII. Removal of Common Faults

### 1. Fault review.

Shutdown caused by parts out of controllers may be removed by inquiring the local fault or fault history, as shown below:

Press the “Down” or “Up” button, to move the scroll bar to “**RUN PARAMETER**” menu, then press “Enter”, the following menu will appear:

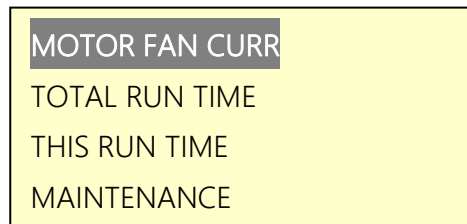

```
MOTOR FAN CURR
TOTAL RUN TIME
THIS RUN TIME
MAINTENANCE
```

Press the “Down” button and the following menu will appear:

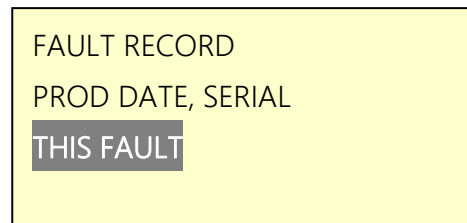

```
FAULT RECORD
PROD DATE, SERIAL
THIS FAULT
```

Go to THIS FAULT, press “Enter” and the fault information will appear:

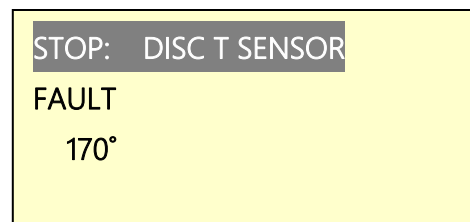

```
STOP: DISC T SENSOR
FAULT
170°
```

User can reset the fault according to the information prompted.

### 2. Common faults and causes

<b>Fault</b>	<b>Probable cause</b>	<b>Remedy</b>
Discharge air temperature too high	Bad vent condition, Oil lacking etc.	Check the vent condition and lubricant level, etc.
Temperature Sensor Failure	Cable off or PT100 damaged	Check the wiring and PT100.
Over Pressure	Pressure too high or pressure sensor failure.	Check the pressure and the pressure sensor.
Pressure Sensor Failure	Cable off, Sensor damaged or cable connection inverted.	Check the wiring and sensor.
Phase Loss	Power phase lacking or Contactor terminal damaged.	Check the power and contactors
Overload	Voltage too low, pipes blocked, damaged bearings or other mechanical problem; wrong set data etc.	Check the set data, voltage, bearings, pipes and mechanical system.
Unbalance	Current unbalance, contactor damaged or internal open circuit of the motor.	Check the power, contactors and motor.
Wrong Phase Sequence	Reversed phase sequence.	Check the wiring
Overload or rotor lock during starting process	Motor start time set to a value lower than the star-delta time delay.	Reset the motor start time to be higher than star-delta delay + Load delay time.
Main contactor activates from time to time.	Loose emergency button.	Check the wiring.

## Servicing

---

KRSD compressors require the minimum amount of inspection and maintenance. The controller and indicator alerts the operator to perform required maintenance or repair unit problems.

### 6.1 FLUID CHANGE

KRSD series compressors utilize a pressurized fluid drain. Use the following procedure to drain and replace the compressor fluid.

- i. Press the emergency stop button and remove the right side cabinet panel (if applicable).
- ii. Check the pressure gauge reading on reservoir and wait until reservoir pressure drops to approximately 0.5Bar (7psig).

- iii. Close the 1/4 turn valve on the blow-down valve.
- iv. Remove the drain plug and attach the 1/4 NPT barb fitting and drain tube (supplied with the unit) to the drain on the oil/air separator tank.
- v. Slowly open the 1/4 turn valve on the drain of oil/air separator tank. The pressure remaining in the tank will force the fluid out. When air begins to escape from the tank, close the valve.
- vi. After closing the valve, remove the tubing and barb fitting and reinstall the drain plug.
- vii. Remove the plug from the fluid fill port and refill the reservoir with the appropriate amount of KTL8000 fluid.
- viii. Before starting the compressor open the 1/4 turn valve on the blow-down valve to ensure the blow-down valve functions correctly.



**NOTICE**

The 1/4 turn valve on the blow-down valve **MUST** be open for the unit to blow down during regular unit operation.

**6.2 AIR FILTER**

The standard Kaishan air filter is a single stage, dry type element. Air filter maintenance should be performed when the maintenance gauge shows red with the compressor running full load, or every 4,000 hours, or once a year, whichever comes first. Daily cleaning of the filter element is common in dirty conditions. If dirty conditions exist, it is advisable to relocate the intake air to an outside source. Each time the filter is serviced, inspect the filtered air side of the air cleaner canister and the suction manifold for dirt. If dirt is found, determine the cause and correct. Always make sure all gaskets, threaded connections, flange connections, and hose connections between the air filter and air compressor are airtight. Dirty filters result in reduced airflow and can distort the element and allow dirt to bypass the filter element.

**Servicing**

---



**NOTICE**

Intake filtration equipment supplied from the factory may not be adequate for extremely dirty applications or some forms of dust or vapors. It is the customer's responsibility to provide adequate filtration for those conditions. Warranty will be voided if inadequate filtration causes a failure.

**6.3 FLUID FILTER**

The fluid filter is a spin on, full flow unit. Replacement of the filter requires spinning off the cartridge and replacing it with a new one. The initial filter change should occur after the

first 500 hours of operation. During normal service, the filter cartridge should be replaced under the following conditions, whichever occurs first:

- ◆ As indicated by the fluid filter maintenance indicator when the fluid is at normal operating temperature
- ◆ Every 2,000 hours
- ◆ Every fluid change



**NOTICE**

The fluid filter maintenance indicator may read high upon start up on cool mornings due to sluggish fluid creating higher than normal differential pressures. Monitor indicator after the fluid warms up.

#### **6.4 AIR/OIL SEPARATOR**

The air/oil separator is a coalescent filter element. Replacement of standard type separator requires unbolting and lifting the separator cover and replacing it with a new one. The air/oil separator should be replaced as indicated in the maintenance schedule or as follows:

- ◆ If excessive fluid carryover is observed.
- ◆ 4,000 hours MAX (for spin on type), 8,000 hours MAX for standard type, or-as indicated by differential pressure indicator.
- ◆ As indicated by the gauge (if equipped).

#### **6.5 FLUID SAMPLING PROCEDURE**

The following is a sampling procedure for oil sump without fixed sampling hardware installed. Check the pressure gauge reading on reservoir and wait until there is no pressure in reservoir. The oil sample is collected by gravity drain into the sample bottle.

- i. Take sample at normal operating conditions or immediately after shutting unit down. That will ensure a homogeneous sample of oil.
- ii. Wipe excess contamination from sample area.
- iii. Remove drain plug. Drain any free water that may accumulate at tank bottom *before* filling sample bottle. If system has drain pipe, flush about 5 times the volume of the dead leg before taking sample.
- iv. Avoid overfilling the sample bottle. Fill sample bottle up to above 80% but below the threads of the bottle. Seal the bottle tightly, wipe clean.

Pre-label or label sample bottle immediately after filling to avoid mix-ups. Make sure bottles are labelled with full sample details.



## 6.5 MAINTENANCE SCHEDULE

This Schedule is intended to be used as a guideline only. Depending on the specific operating conditions of your KRSD compressor, maintenance requirements may vary. The instructions in this section will give more details about determining when specific service should be performed.

First 500 hours	Change fluid filter and check fluid level
Every 500 hours	Drain water from air/oil separator tank.  Check fluid level  Clean air filter  Clean after-cooler fins.  Check for loose fluid and air tubing, electrical wiring connection.
Every 1000 hours	Clean air filter or replace with new element.  Clean after-cooler fins.
Every 2000 hours	Check safety valve  Replace fluid filter.  Perform fluid sampling.
Every 4000 hours	Replace air filter.  Replace air/oil separator (spin on type)
Every 8000 hours	Check equipment power supply and earth-grounding.  Replace air/oil separator (standard type).  Replace fluid.

## Troubleshooting Guide

Information below is a troubleshooting guideline; it describes symptoms and possible cause. Do not assume that these are the only faulty condition that may occur.

<b>Table 7-1: TROUBLE SHOOTING GUIDE</b>		
<b>Symptom</b>	<b>Possible Cause</b>	<b>Solution</b>
Fail to Start	Power failure	Check power supply to the unit
	Low incoming voltage	Check voltage and power source, or contact local power company.
	Fuse blown	Replace Fuse
	Faulty start switch	Check the switch for malfunction or loose connection.
	Emergency button	Reset emergency button
	Motor starter overload tripped	Check motor starter wiring before removing motor. Remove motor and have tested at motor manufacturer repair center.
	Loose wire connections	Check all wiring terminals for contact and tightness
	Air-end failure	Contact a local authorized distributor.
Compressor shuts down during loaded condition	High ambient temperature	Make fresh air intake openings or install ducts to discharge the hot air.
	Low incoming voltage	Check voltage and power source, or contact local power company.
	High operating pressure	Reset, check line pressure and ensure it does not exceed the compressor's maximum operating pressure.
	Low fluid level	Top-up fluid
	PLC controller indicate separator requires maintenance	Replace separator element.
Line pressure rises above unload pressure set-point	Control system air leakage causing loss of pressure	Check for leak
	Plugged air filter	Replace air filter element
	Air Intake valve stuck open	Remove the intake hose and check the inlet valve for proper operation
	Defective blow-down valve	Check the receiver tank to ensure that it is exhausting air to the atmosphere when the solenoid opens - repair or replace if necessary.

**Table 7-1: TROUBLE SHOOTING GUIDE (Continued)**

<b>Symptom</b>	<b>Possible Cause</b>	<b>Solution</b>
Compressor does not reload when service line pressure drops to reset	Faulty solenoid	Repair or replace as necessary
	Loose wiring connection	Check and tighten wiring terminals
	Faulty proportional valve	Orifice plugged. Clean or replace as necessary
	Jammed air inlet valve assembly	Check and repair air inlet valve
	Faulty air pressure sensor	Repair or replace as necessary
High air discharge temperature	Low Fluid Level	Check oil level
	Incorrect fluid brand	Check oil code number, replace as necessary
	High ambient temperature	Check air exhaust, reduce room temperature.
	Plugged oil filter	Change oil filter
	Plugged internal aftercooler	Chemical cleaning for after-cooler
	Dusty after-cooler fins	Chemical wash for after-cooler fins
	Fan motor setting	Adjust
	Temperature sensor failure	Check and replace as necessary
	Loose wire	Check and tighten
Low air capacity delivery	Plugged air filter	Clean air filter or replace with new element
	Air Intake valve failure	Remove the intake hose and check the inlet valve for proper operation
	Separator failure	Replace separator element
	Faulty indirect proportional valve	Adjust or replace as necessary
	Faulty solenoid	Repair or replace as necessary
	Faulty safety valve	Repair or replace as necessary
Excessive oil carry over in discharge compressed air.	High oil level	Check oil level
	Plugged oil orifice valve	Clean or replace as necessary
	Low discharge pressure	Adjust
	Air/oil separator element failure	Clean or replace as necessary
	Minimum pressure valve malfunction	Check for leaking, replace as necessary
Loading function Failure	Solenoid valve failure	Check and replace as necessary
	Pipe leak	Check and replace as necessary
	Proportional valve failure	Check and replace as necessary
	Air Intake valve stuck open	Remove the intake hose and check the inlet valve for proper operation
	Minimum pressure valve failure	Check for leaking, replace as necessary

<b>Table 7-1: TROUBLE SHOOTING GUIDE (Continued)</b>		
<b>Symptom</b>	<b>Possible Cause</b>	<b>Solution</b>
Unloading failure at working pressure, causing safety valve to release pressure	Pressure loading setting	Adjust as necessary
	Solenoid valve failure	Check and replace as necessary
	Plugged air/oil separator	Check and replace as necessary
	Air Intake valve stuck open	Remove the intake hose and check the inlet valve for proper operation
	Safety valve failure	Repair or replace as necessary
	PLC controller failure	Check and replace as necessary
Compressor air discharge pressure below normal operating settings	Plugged air filter	Clean or replace as necessary
	Air Intake valve stuck closed	Remove the intake hose and check the inlet valve for proper operation
	Plugged air/oil separator	Check or replace as necessary
	Indirect proportional valve setting	Adjust or replace as necessary
	Solenoid valve failure	Check and replace as necessary
	Safety valve failure	Check and replace as necessary
Short period of load/unload	Pipe leak	Check and replace as necessary
	Pressure setting	Change setting above 1Bar
	Receiver tank too small	Check or increase volume of receiver tank
	Air flow into the main network restricted	Increase pipe size. Checks filter cartridge failure.
Oil vapor leak from air filter when compressor stops	Air inlet valve failure	Check and replace as necessary
	Minimum pressure valve failure	Check for leaks and replace as necessary
	Pressure relief valve failure	Check and replace as necessary
Excessive Fluid Consumption	Different oil is being used.	Use KRSD genuine fluid.
	Separator element damaged	Check and replace as necessary.
	Oil level too high	Drain off oil until the correct level.
	Fluid foaming	Drain off oil and change
	Oil return line or orifice clogged	Clean and replace as necessary.

## Standard Terms and Conditions

---

These terms and conditions govern the sale of Products (“Rotary Screw Air Compressors and parts”) and provisions of services by Kaishan Compressor USA, Ltd. (Seller) and its authorized representative or buyer. These terms and conditions (“Agreement”) take precedence over Buyer’s supplemental or conflicting terms and conditions to which notice of objection is hereby given. Neither Seller’s commencement of performance or delivery shall be deemed or construed as acceptance of Buyer’s supplemental or conflicting terms and conditions. Kaishan Compressor’s failure to object to conflicting or additional terms will not change or add to the terms of this agreement. Buyer’s acceptance of the Products and/or Services from Seller shall be deemed to constitute acceptance of the terms and conditions contained herein.

**Orders:** All orders placed by Buyer are subject to acceptance by Seller. Orders may not be canceled or rescheduled without Seller’s written consent. All orders must identify the products, unit quantities, part numbers, applicable prices and requested delivery dates of the Products being purchased. Seller may at its sole discretion allocate Product among its Buyer. Seller may designate certain Products and Services as non-cancelable, non-returnable and the sale of such Products shall be subject to the special terms and conditions contained in Seller’s Customer Acknowledgment or Non-Returnable Product Form, which shall prevail and supersede any inconsistent terms and conditions contained herein or elsewhere.

**Prices:** The prices of the Products are those prices specified on the front of the invoice or contained within an agreed written contract. Price quotations shall automatically expire in thirty (30) days from the date issued, or as otherwise stated in the quotation.

**Taxes:** Unless otherwise agreed to in writing by Seller, all prices quoted are exclusive of transportation and insurance costs, duties, and all taxes including federal, state and local sales, excise and value added, goods and services taxes, and any other taxes. Buyer agrees to indemnify and hold Seller harmless for any liability for tax in connection with the sale, as well as the collection or withholding thereof, including penalties and interest thereon. When applicable, transportation and taxes shall appear as separate items on Seller’s invoice.

**Payment:** Payment may be made by check, money order, credit card, or wire transfer (all fees are borne by the Buyer). Where Seller has extended credit to Buyer, terms of payment shall be net thirty (30) days from date of invoice, without offset or deduction. On any past due invoice, Seller may impose a monthly interest rate. If Buyer fails to make the required payments the Seller will impose the interest rate each month. If Buyer fails to make each payment when it is due, Seller reserves the right to withdraw credit and thereby suspend or cancel performance under any or all purchase orders or agreements in which Seller has extended credit to Buyer. In the event of default by Buyer, Seller shall be entitled to costs, fees, and expenses including but not limited to recovery of attorney fees, court costs and fees, and collections costs.

**Delivery and Title:** The locations of shipment delivery will be made according to the Seller and Buyer agreement. Title and risk of loss pass to the Buyer upon delivery of the Product to

the carrier. Seller's delivery dates are estimates only and Seller is not liable for delays in delivery or for failure to perform due to causes beyond the reasonable control of the Seller, nor shall the carrier be deemed an agent of the Seller. A delayed delivery of any part of an Order does not entitle Buyer to cancel other deliveries. Kaishan Compressor will comply with various federal, state and local laws and regulation concerning occupational health, safety and environment concerns. Buyer has full responsibility to comply with those laws and regulations during the installation and operation of the equipment.

**Acceptance / Returns:** Shipments will be deemed to have been accepted by Buyer upon delivery of the said shipments to Buyer unless rejected upon receipt. Buyer shall perform all inspections and tests. Buyer deems necessary as promptly as possible but in no event later than 7 days after receipt of Products, at which time Buyer will be deemed to have irrevocably accepted the Products. Any discrepancy in shipment quantity must be reported within 7 days after receipt of Products. Buyer may not return Products without a Return Material Authorization ("RMA") number. RMA's valid for 30 days from the date issued.

**Standard Warranty:** Buyer will honor Product warranties and indemnities authorized by the manufacturer, including any transferable. 90 days warranty is given for service parts from receipt date. Seller warrants to Buyer that Products purchased hereunder will conform to the applicable manufacturer's specifications for such products and that any value-added work performed by Seller on such Products will conform to applicable Buyer's specifications. If Seller breaches this warranty, Buyer's remedy is limited to (at Seller's election) (1) refund of Buyer's purchase price for such Product (without interest), (2) repair of such Products, or (3) replacement of such Products provided that such Products must be returned to Seller, along with acceptable evidence of purchase within 13 days from date of delivery, transportation charges prepaid. No warranty will apply if the Product has been subject to misuse, neglect, accident or modification.

**Limitation of Liabilities:** Buyer shall not be entitled to, and Seller shall not be liable for, loss of profit or revenue, promotional or manufacturing expenses, overheads expenses, business interruption cost, loss of data, removal or reinstallation costs, injury to reputation of buyer, punitive damages, loss of contractor orders or any indirect, special, incidental or consequential damages of any nature. Buyer's recovery from seller for any claim shall not exceed the purchase price paid for the affected products irrespective of the nature of the claim whether in contract, tort, warranty, or otherwise. Buyer will indemnify, defend and hold seller harmless from any claims based on (a) Seller's compliance with buyer's designs, specifications, or instructions, (b) Modification of any products by anyone other than Seller, or (c) use in combination with other products not supplied by seller.

**Use of Products:** Unless otherwise specified. Products sold by Seller are not designed, intended or authorized for use in life support, life sustaining, nuclear, or other applications in which the failure of such Products could reasonably be expected to result in personal injury, loss of life or catastrophic property damage. If buyer uses or sales the Products for use in any such applications: (1) Buyer acknowledges that such use or sale is at Buyer's sole risk; (2) Buyer agrees that Seller and the manufacturer of the Products are not liable, in whole or in part, for any claim or damage arising from such use; and (3) Buyer agrees to indemnify, defend and hold Seller and the manufacturer of the Products harmless from and against any and all claims, damages, losses, costs, expenses and liabilities arising out of or in connection with such use or sale.

**Force Majeure:** Seller is not liable for failure to fulfill its obligations for any accepted Order or for delays in delivery due to causes beyond Seller's reasonable control including, but not limited to, acts of God, natural or artificial disaster, riot, war, strike, delay by carrier, shortage of Product, acts or omissions of other parties, acts or omissions of civil or military authority, Government priorities, changes in law, material shortages, fire, strikes, floods, epidemics, quarantine restrictions, acts of terrorism, delays in transportation or inability to obtain labor, materials or products through its regular sources, which shall be considered as an event of force majeure excusing Seller from performance and barring remedies for non-performance. In an event of force majeure condition, the Seller's time for performance shall be extended for a period equal to the time lost as a consequence of the force majeure condition without subjecting Seller to any liability or penalty. Seller may, at its option, cancel the remaining performance, without any liability or penalty, by giving notice of such cancellation to the Buyer.

**General:** (a) Seller will comply with state law for any dispute from buyer. (b) Buyer may not assign this Agreement without the prior written consent of Seller. Seller or its affiliates may perform the obligations under this Agreement. This Agreement is binding on successor and assigns, (c) Products, including software or other intellectual property, are subject to any applicable rights of third parties, such as patents, copyrights and/or user licenses.

## Contact Information

---

Kaishan Compressor, LLC.,

Add.: 7650-A Stanton St., Daphne, AL ,Post code: 36526

Office number: +1 251-202-0577

[www.KaishanUSA.com](http://www.KaishanUSA.com)