

# Oil-injected rotary screw compressors



**Chicago  
Pneumatic**



People. Passion. Performance.

**QRS 10, QRS 15, QRSM 20**

Instruction book



# Chicago Pneumatic

## Oil-injected rotary screw compressors

QRS 10, QRS 15, QRSM 20

From following serial No. onwards: ITJ 00 00 01

### Instruction book

Original instructions

### Copyright notice

Any unauthorized use or copying of the contents or any part thereof is prohibited.

This applies in particular to trademarks, model denominations, part numbers and drawings.

This instruction book is valid for CE as well as non-CE labelled machines. It meets the requirements for instructions specified by the applicable European directives as identified in the Declaration of Conformity.

2017 - 03

No. 2920 7114 70

[www.cp.com](http://www.cp.com)



---

## Table of contents

|          |  |           |
|----------|--|-----------|
| <b>1</b> | <b>Safety precautions.....</b>                       | <b>5</b>  |
| 1.1      | SAFETY ICONS.....                                    | 5         |
| 1.2      | GENERAL SAFETY PRECAUTIONS.....                      | 5         |
| 1.3      | SAFETY PRECAUTIONS DURING INSTALLATION.....          | 6         |
| 1.4      | SAFETY PRECAUTIONS DURING OPERATION.....             | 7         |
| 1.5      | SAFETY PRECAUTIONS DURING MAINTENANCE OR REPAIR..... | 8         |
| <b>2</b> | <b>General description.....</b>                      | <b>11</b> |
| 2.1      | INTRODUCTION.....                                    | 11        |
| 2.2      | AIR FLOW.....  | 14        |
| 2.3      | OIL SYSTEM.....                                      | 16        |
| 2.4      | COOLING SYSTEM.....                                  | 17        |
| 2.5      | REGULATING SYSTEM.....                               | 18        |
| 2.6      | CONTROL PANEL .....                                  | 19        |
| 2.7      | ELECTRICAL SYSTEM.....                               | 20        |
| 2.8      | PROTECTION OF THE COMPRESSOR.....                    | 23        |
| 2.9      | AIR DRYER.....                                       | 24        |
| <b>3</b> | <b>Controller.....</b>                               | <b>25</b> |
| 3.1      | CONTROLLER.....                                      | 25        |
| 3.2      | CONTROL PANEL.....                                   | 26        |
| 3.3      | ICONS USED ON THE DISPLAY.....                       | 27        |
| 3.4      | MAIN SCREEN.....                                     | 28        |
| 3.5      | MAIN FUNCTION.....                                   | 29        |
| 3.6      | SHUTDOWN WARNING.....                                | 31        |
| 3.7      | SHUTDOWN.....  | 32        |
| 3.8      | SERVICE WARNING.....                                 | 34        |
| 3.9      | SCROLLING THROUGH ALL SCREENS.....                   | 36        |

|          |   |           |
|----------|---|-----------|
| 3.10     | CALLING UP RUNNING HOURS.....                           | 37        |
| 3.11     | CALLING UP MOTOR STARTS.....                            | 38        |
| 3.12     | CALLING UP MODULE HOURS.....                            | 38        |
| 3.13     | CALLING UP LOADING HOURS.....                           | 39        |
| 3.14     | CALLING UP LOAD SOLENOID VALVE.....                     | 39        |
| 3.15     | CALLING UP/RESETTING THE SERVICE TIMER.....             | 40        |
| 3.16     | CALLING UP/MODIFYING PRESSURE BAND SELECTION.....       | 40        |
| 3.17     | CALLING UP/MODIFYING PRESSURE BAND SETTINGS.....        | 41        |
| 3.18     | CALLING UP/MODIFYING THE UNIT OF TEMPERATURE.....       | 41        |
| 3.19     | CALLING UP/MODIFYING THE UNIT OF PRESSURE.....          | 42        |
| 3.20     | CALLING UP/MODIFYING BACKLIGHT TIME.....                | 42        |
| 3.21     | ACTIVATING AUTOMATIC RESTART AFTER VOLTAGE FAILURE..... | 42        |
| 3.22     | KEYBOARD LOCK.....                                      | 43        |
| <b>4</b> | <b>Installation.....</b>                                | <b>44</b> |
| 4.1      | INSTALLATION PROPOSAL.....                              | 44        |
| 4.2      | DIMENSION DRAWINGS.....                                 | 47        |
| 4.3      | ELECTRICAL CONNECTIONS .....                            | 48        |
| 4.4      | PICTOGRAPHS.....  | 51        |
| <b>5</b> | <b>Operating instructions.....</b>                      | <b>53</b> |
| 5.1      | INITIAL START-UP.....                                   | 53        |
| 5.2      | STARTING.....   | 56        |
| 5.3      | STOPPING.....   | 58        |
| 5.4      | TAKING OUT OF OPERATION.....                            | 59        |
| <b>6</b> | <b>Maintenance.....</b>                                 | <b>61</b> |
| 6.1      | PREVENTIVE MAINTENANCE SCHEDULE.....                    | 61        |
| 6.2      | DRIVE MOTOR .....                                       | 62        |
| 6.3      | OIL SPECIFICATIONS.....                                 | 63        |



---

|           |  |           |
|-----------|--|-----------|
| 6.4       | OIL, FILTER AND SEPARATOR CHANGE .....           | 63        |
| 6.5       | STORAGE AFTER INSTALLATION.....                  | 65        |
| 6.6       | SERVICE KITS.....                                | 65        |
| 6.7       | DISPOSAL OF USED MATERIAL.....                   | 65        |
| <b>7</b>  | <b>Adjustments and servicing procedures.....</b> | <b>66</b> |
| 7.1       | AIR FILTER.....                                  | 66        |
| 7.2       | COOLERS.....                                     | 67        |
| 7.3       | SAFETY VALVE .....                               | 67        |
| 7.4       | BELT SET EXCHANGE AND TENSIONING .....           | 69        |
| <b>8</b>  | <b>Problem solving.....</b>                      | <b>72</b> |
| <b>9</b>  | <b>Technical data.....</b>                       | <b>76</b> |
| 9.1       | ELECTRIC CABLE SIZE.....                         | 76        |
| 9.2       | SETTINGS FOR OVERLOAD RELAY AND FUSES.....       | 76        |
| 9.3       | REFERENCE CONDITIONS AND LIMITATIONS.....        | 77        |
| 9.4       | COMPRESSOR DATA.....                             | 77        |
| <b>10</b> | <b>Instructions for use.....</b>                 | <b>80</b> |
| <b>11</b> | <b>Guidelines for inspection.....</b>            | <b>81</b> |

# 1 Safety precautions

## 1.1 Safety icons

### Explanation

|   |                |
|---|----------------|
|  | Danger to life |
|  | Warning        |
|  | Important note |

## 1.2 General safety precautions

1. The operator must employ safe working practices and observe all related work safety requirements and regulations.
2. If any of the following statements does not comply with the applicable legislation, the stricter of the two shall apply.
3. Installation, operation, maintenance and repair work must only be performed by authorized, trained, specialized personnel. The personnel should apply safe working practices by use of personal protection equipment, appropriate tools and defined procedures.
4. The compressor is not considered capable of producing air of breathing quality. For air of breathing quality, the compressed air must be adequately purified according to the applicable legislation and standards.
5. Before any maintenance, repair work, adjustment or any other non-routine checks:
  - Stop the machine
  - Press the emergency stop button
  - Switch off the voltage
  - Depressurize the machine
  - Lock Out - Tag Out (LOTO):
    - Open the power isolating switch and lock it with a personal lock
    - Tag the power isolating switch with the name of the service technician.
  - On units powered by a frequency converter, wait 10 minutes before starting any electrical repair.
  - Never rely on indicator lamps or electrical door locks before maintenance work, always disconnect and check with measuring device.

|   |   |
|---|---|
|  | If the machine is equipped with an automatic restart after voltage failure function and if this function is active, be aware that the machine will restart automatically when the power is restored if it was running when the power was interrupted! |
|---|---|

6. Never play with compressed air. Do not apply the air to your skin or direct an air stream at people. Never use the air to clean dirt from your clothes. When using the air to clean equipment, do so with extreme caution and wear eye protection.
7. The owner is responsible for maintaining the unit in safe operating condition. Parts and accessories shall be replaced if unsuitable for safe operation.
8. It is prohibited to walk or stand on the unit or on its components.

9. If compressed air is used in the food industry and more specifically for direct food contact, it is recommended, for optimal safety, to use certified Class 0 compressors in combination with appropriate filtration depending on the application. Please contact your customer center for advice on specific filtration.

## 1.3 Safety precautions during installation



All responsibility for any damage or injury resulting from neglecting these precautions, or non observance of the normal caution and care required for installation, operation, maintenance and repair, even if not expressly stated, will be disclaimed by the manufacturer.

### Precautions during installation

1. The machine must only be lifted using suitable equipment in accordance with the applicable safety regulations. Loose or pivoting parts must be securely fastened before lifting. It is strictly forbidden to dwell or stay in the risk zone under a lifted load. Lifting acceleration and deceleration must be kept within safe limits. Wear a safety helmet when working in the area of overhead or lifting equipment.
2. The unit is designed for indoor use. If the unit is installed outdoors, special precautions must be taken; consult your supplier.
3. In case the device is a compressor, place the machine where the ambient air is as cool and clean as possible. If necessary, install a suction duct. Never obstruct the air inlet. Care must be taken to minimize the entry of moisture at the inlet air.
4. Any blanking flanges, plugs, caps and desiccant bags must be removed before connecting the pipes.
5. Air hoses must be of correct size and suitable for the working pressure. Never use frayed, damaged or worn hoses. Distribution pipes and connections must be of the correct size and suitable for the working pressure.
6. In case the device is a compressor, the aspirated air must be free of flammable fumes, vapors and particles, e.g. paint solvents, that can lead to internal fire or explosion.
7. In case the device is a compressor, arrange the air intake so that loose clothing worn by people cannot be drawn in.
8. Ensure that the discharge pipe from the compressor to the aftercooler or air net is free to expand under heat and that it is not in contact with or close to flammable materials.
9. No external force may be exerted on the air outlet valve; the connected pipe must be free of strain.
10. If remote control is installed, the machine must bear a clear sign stating: DANGER: This machine is remotely controlled and may start without warning.  
The operator has to make sure that the machine is stopped and depressurized and that the electrical isolating switch is open, locked and labelled with a temporary warning before any maintenance or repair. As a further safeguard, persons switching on or off remotely controlled machines shall take adequate precautions to ensure that there is no one checking or working on the machine. To this end, a suitable notice shall be affixed to the start equipment.
11. Air-cooled machines must be installed in such a way that an adequate flow of cooling air is available and that the exhausted air does not recirculate to the compressor air inlet or cooling air inlet.



12. The electrical connections must correspond to the applicable codes. The machines must be earthed and protected against short circuits by fuses in all phases. A lockable power isolating switch must be installed near the compressor.
13. On machines with automatic start/stop system or if the automatic restart function after voltage failure is activated, a sign stating "This machine may start without warning" must be affixed near the instrument panel.
14. In multiple compressor systems, manual valves must be installed to isolate each compressor. Non-return valves (check valves) must not be relied upon for isolating pressure systems.
15. Never remove or tamper with the safety devices, guards or insulation fitted on the machine. Every pressure vessel or auxiliary installed outside the machine to contain air above atmospheric pressure must be protected by a pressure relieving device or devices as required.
16. Piping or other parts with a temperature in excess of 70°C (158°F) and which may be accidentally touched by personnel in normal operation must be guarded or insulated. Other high temperature piping must be clearly marked.
17. For water-cooled machines, the cooling water system installed outside the machine has to be protected by a safety device with set pressure according to the maximum cooling water inlet pressure.
18. If the ground is not level or can be subject to variable inclination, consult the manufacturer.
19. If the device is a dryer and no free extinguishing system is present in the air net close to the dryer, safety valves must be installed in the vessels of the dryer.



Also consult following safety precautions: [Safety precautions during operation](#) and [Safety precautions during maintenance](#).  
 These precautions apply to machinery processing or consuming air or inert gas. Processing of any other gas requires additional safety precautions typical to the application which are not included herein.  
 Some precautions are general and cover several machine types and equipment; hence some statements may not apply to your machine.

## 1.4 Safety precautions during operation



All responsibility for any damage or injury resulting from neglecting these precautions, or non observance of the normal caution and care required for installation, operation, maintenance and repair, even if not expressly stated, will be disclaimed by the manufacturer.

### Precautions during operation

1. Never touch any piping or components of the machine during operation.
2. Use only the correct type and size of hose end fittings and connections. When blowing through a hose or air line, ensure that the open end is held securely. A free end will whip and may cause injury. Make sure that a hose is fully depressurized before disconnecting it.
3. Persons switching on remotely controlled machines shall take adequate precautions to ensure that there is no one checking or working on the machine. To this end, a suitable notice shall be affixed to the remote start equipment.
4. Never operate the machine when there is a possibility of taking in flammable or toxic fumes, vapors or particles.
5. Never operate the machine below or in excess of its limit ratings.

6. Keep all bodywork doors shut during operation. The doors may be opened for short periods only, e.g. to carry out routine checks. Wear ear protectors when opening a door. On machines without bodywork, wear ear protection in the vicinity of the machine.
7. People staying in environments or rooms where the sound pressure level reaches or exceeds 80 dB(A) shall wear ear protectors.
8. Periodically check that:
  - All guards are in place and securely fastened
  - All hoses and/or pipes inside the machine are in good condition, secure and not rubbing
  - No leaks occur
  - All fasteners are tight
  - All electrical leads are secure and in good order
  - Safety valves and other pressure relief devices are not obstructed by dirt or paint
  - Air outlet valve and air net, i.e. pipes, couplings, manifolds, valves, hoses, etc. are in good repair, free of wear or abuse
  - Air cooling filters of the electrical cabinet are not clogged
9. If warm cooling air from compressors is used in air heating systems, e.g. to warm up a workroom, take precautions against air pollution and possible contamination of the breathing air.
10. On water-cooled compressors using open circuit cooling towers, protective measures must be taken to avoid the growth of harmful bacteria such as Legionella pneumophila bacteria.
11. Do not remove any of, or tamper with, the sound-damping material.
12. Never remove or tamper with the safety devices, guards or insulations fitted on the machine. Every pressure vessel or auxiliary installed outside the machine to contain air above atmospheric pressure shall be protected by a pressure relieving device or devices as required.
13. Yearly inspect the air receiver. Minimum wall thickness as specified in the instruction book must be respected. Local regulations remain applicable if they are more strict.



Also consult following safety precautions: [Safety precautions during installation](#) and [Safety precautions during maintenance](#).

These precautions apply to machinery processing or consuming air or inert gas. Processing of any other gas requires additional safety precautions typical to the application which are not included herein.

Some precautions are general and cover several machine types and equipment; hence some statements may not apply to your machine.

## 1.5 Safety precautions during maintenance or repair



All responsibility for any damage or injury resulting from neglecting these precautions, or non observance of the normal caution and care required for installation, operation, maintenance and repair, even if not expressly stated, will be disclaimed by the manufacturer.

### Precautions during maintenance or repair

1. Always use the correct safety equipment (such as safety glasses, gloves, safety shoes, etc.).
2. Use only the correct tools for maintenance and repair work.

3. Use only genuine spare parts for maintenance or repair. The manufacturer will disclaim all damage or injuries caused by the use of non-genuine spare parts.
4. All maintenance work shall only be undertaken when the machine has cooled down.
5. A warning sign bearing a legend such as "Work in progress; do not start" shall be attached to the starting equipment.
6. Persons switching on remotely controlled machines shall take adequate precautions to ensure that there is no one checking or working on the machine. To this end, a suitable notice shall be affixed to the remote start equipment.
7. Close the compressor air outlet valve and depressurize the compressor before connecting or disconnecting a pipe.
8. Before removing any pressurized component, effectively isolate the machine from all sources of pressure and relieve the entire system of pressure.
9. Never use flammable solvents or carbon tetrachloride for cleaning parts. Take safety precautions against toxic vapors of cleaning liquids.
10. Scrupulously observe cleanliness during maintenance and repair. Keep dirt away by covering the parts and exposed openings with a clean cloth, paper or tape.
11. Never weld or perform any operation involving heat near the oil system. Oil tanks must be completely purged, e.g. by steam cleaning, before carrying out such operations. Never weld on, or in any way modify, pressure vessels.
12. Whenever there is an indication or any suspicion that an internal part of a machine is overheated, the machine shall be stopped but no inspection covers shall be opened before sufficient cooling time has elapsed; this to avoid the risk of spontaneous ignition of the oil vapor when air is admitted.
13. Never use a light source with open flame for inspecting the interior of a machine, pressure vessel, etc.
14. Make sure that no tools, loose parts or rags are left in or on the machine.
15. All regulating and safety devices shall be maintained with due care to ensure that they function properly. They may not be put out of action.
16. Before clearing the machine for use after maintenance or overhaul, check that operating pressures, temperatures and time settings are correct. Check that all control and shut-down devices are fitted and that they function correctly. If removed, check that the coupling guard of the compressor drive shaft has been reinstalled.
17. Every time the separator element is renewed, examine the discharge pipe and the inside of the oil separator vessel for carbon deposits; if excessive, the deposits should be removed.
18. Protect the motor, air filter, electrical and regulating components, etc. to prevent moisture from entering them, e.g. when steam cleaning.
19. Make sure that all sound-damping material and vibration dampers, e.g. damping material on the bodywork and in the air inlet and outlet systems of the compressor, is in good condition. If damaged, replace it by genuine material from the manufacturer to prevent the sound pressure level from increasing.
20. Never use caustic solvents which can damage materials of the air net, e.g. polycarbonate bowls.
21. **Only if applicable, the following safety precautions are stressed when handling refrigerant:**
  - Never inhale refrigerant vapors. Check that the working area is adequately ventilated; if required, use breathing protection.
  - Always wear special gloves. In case of refrigerant contact with the skin, rinse the skin with water. If liquid refrigerant contacts the skin through clothing, never tear off or remove the latter; flush abundantly with fresh water over the clothing until all refrigerant is flushed away; then seek medical first aid.



Also consult following safety precautions: [Safety precautions during installation](#) and [Safety precautions during operation](#).  
These precautions apply to machinery processing or consuming air or inert gas. Processing of any other gas requires additional safety precautions typical to the application which are not included herein.  
Some precautions are general and cover several machine types and equipment; hence some statements may not apply to your machine.

## 2 General description

### 2.1 Introduction

#### Introduction

QRS 10, QRS 15, QRSM 20 are air-cooled, single-stage, oil-injected screw compressors, driven by an electric motor.

The compressors are enclosed in sound-insulating bodywork.

An easy-to-operate control panel is provided, including the start/stop switch and the emergency stop button. A cabinet housing the controller, pressure sensor and motor starter is integrated into the bodywork.

#### Floor-mounted model

The compressor is installed directly on the floor.

Floor mounted units are available without dryer only.

#### Tank-mounted model

QRS 10, QRS 15, QRSM 20 tank-mounted are supplied with an air receiver of 270 l (71.28 US gal / 59.40 Imp gal / 9.45 cu.ft) or 500 l (132 US gal / 110 Imp gal / 17.50 cu.ft).

Tank-mounted units are available with or without dryer.

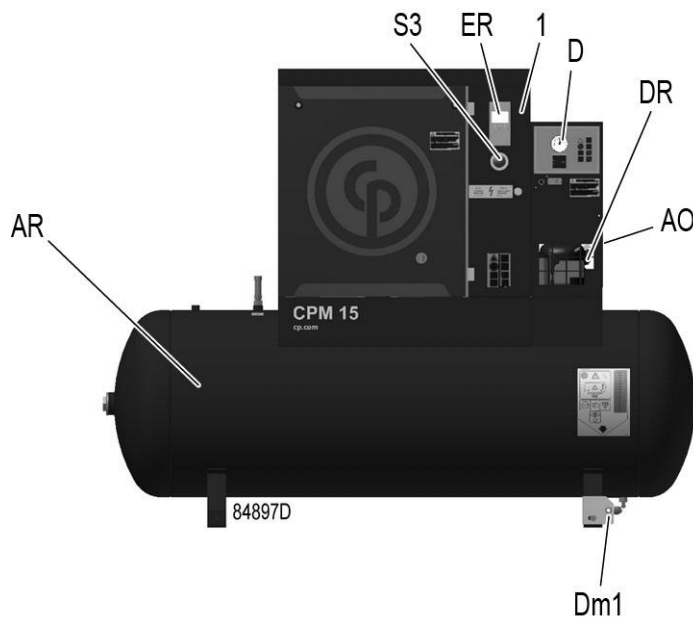

Front view, tank-mounted with dryer

| Reference | Designation      |
|-----------|------------------|
| 1         | Electric cabinet |
| ER        | Controller       |

| Reference | Designation                                   |
|-----------|---|
| S3        | Emergency stop button                         |
| AO        | Air outlet                                    |
| AR        | Air receiver                                  |
| Dm1       | Manual condensate drain                       |
| DR        | Dryer   |
| D         | Dewpoint indicator (Only on units with dryer) |

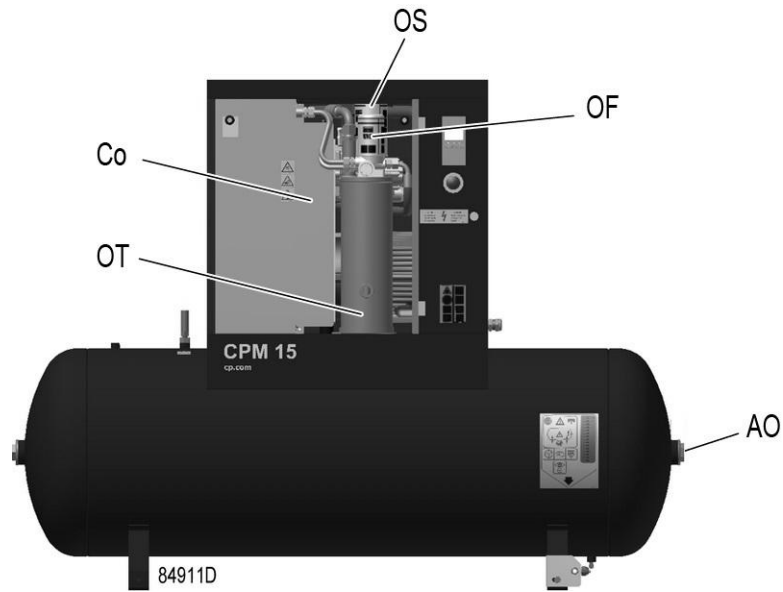

Front open view, tank-mounted

| Reference | Designation        |
|-----------|--------------------|
| Co        | Oil cooler         |
| OF        | Oil filter         |
| OS        | Oil separator      |
| OT        | Oil separator tank |

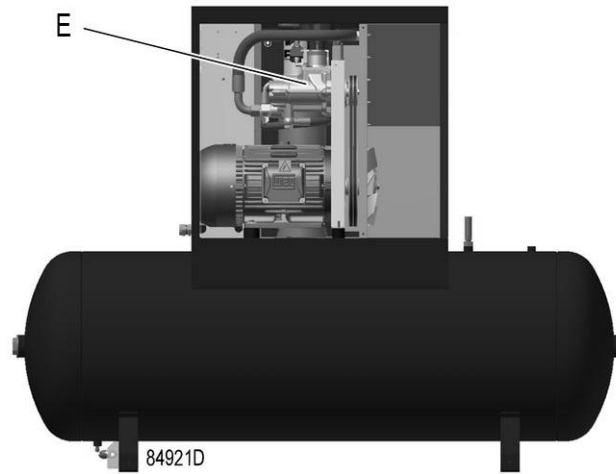

*Rear open view, tank-mounted*



*Air filter*

| Reference | Designation        |
|-----------|--------------------|
| E         | Compressor element |
| AF        | Air filter         |

## 2.2 Air flow

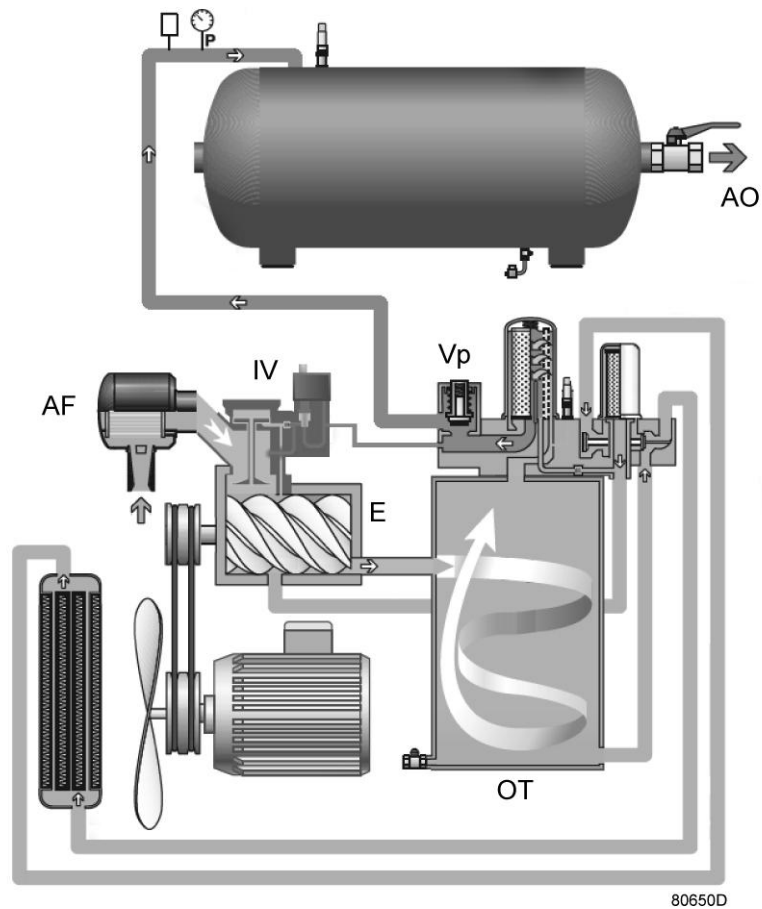

*Air flow, Tank-mounted*

Air drawn through filter (AF) and open inlet valve (IV) into compressor element (E) is compressed. Compressed air and oil flow into oil separator/tank (OT). The air is discharged via minimum pressure valve (Vp) towards the air outlet (AO).



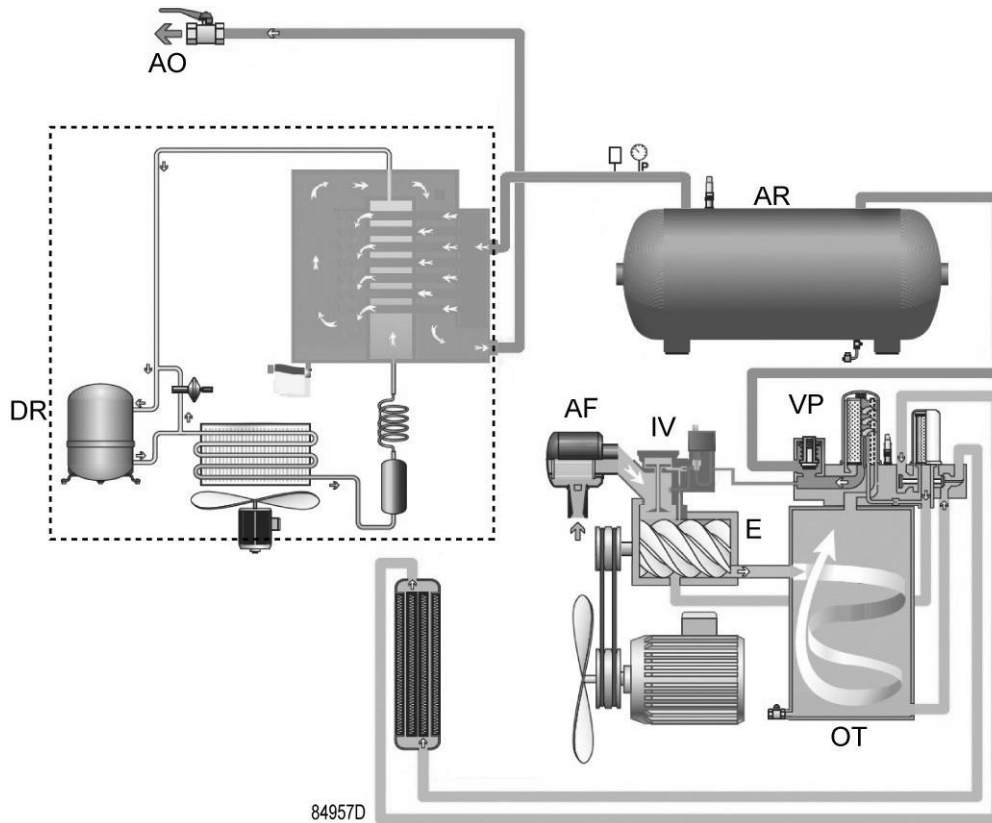

*Air flow, Tank-mounted with dryer*

Air drawn through filter (AF) and open inlet valve (IV) into compressor element (E) is compressed. Compressed air and oil flow into oil separator/tank (OT). The air is discharged via minimum pressure valve (VP), air receiver (AR) and air dryer (DR) towards the air outlet (AO).

## 2.3 Oil system

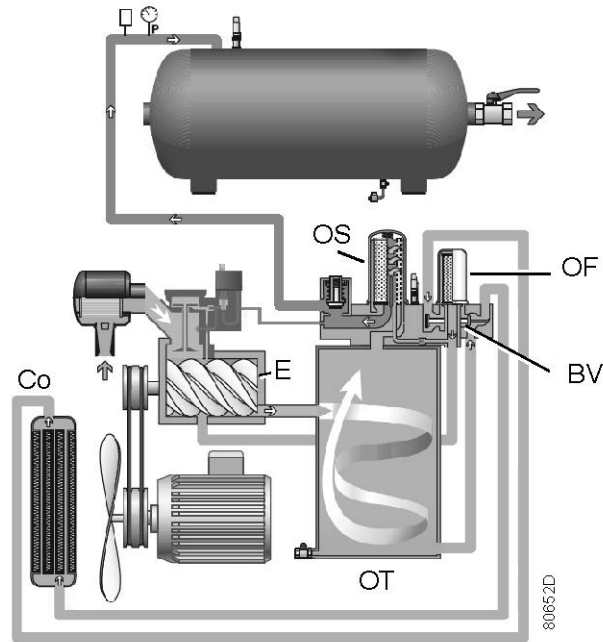

*Oil system*

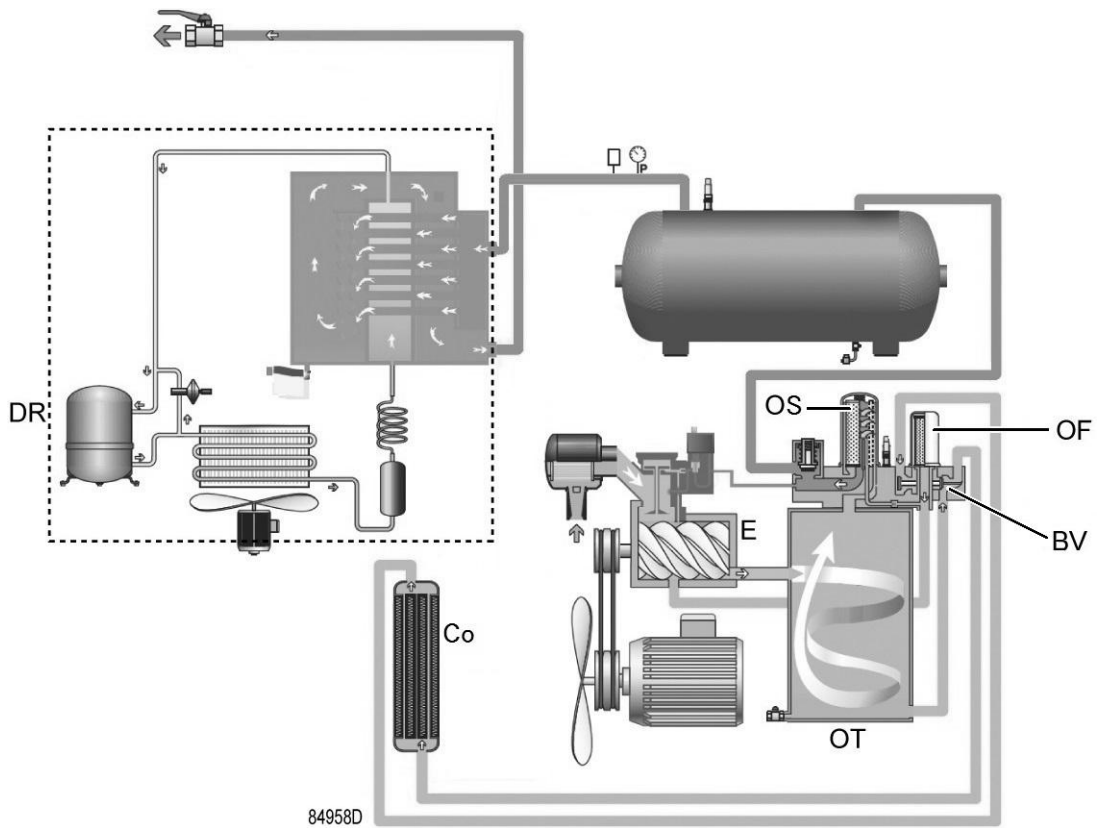

*Oil system, units with dryer*

Air pressure in the oil separator tank (OT) forces the oil from the tank to compressor element (E) via oil cooler (Co) and oil filter (OF). Compressed air and oil flow into oil separator/tank (OT) where most of the oil is separated from the air by centrifugal action. The remaining oil is removed by oil separator (OS) and returns to the oil circuit via a separate line. The minimum pressure valve (Vp - see section [Air flow](#)) ensures a minimal pressure in the tank, required for oil circulation under all circumstances.

The oil system is fitted with a by-pass valve (BV). When the oil temperature is below the set-point of the valve, the by-pass valve shuts off the oil supply from oil cooler. The by-pass valve starts opening the supply from cooler (Co) when the oil temperature exceeds the setting of the valve. The setting of the by-pass valve depends on the model. See the section [Compressor data](#).

## 2.4 Cooling system

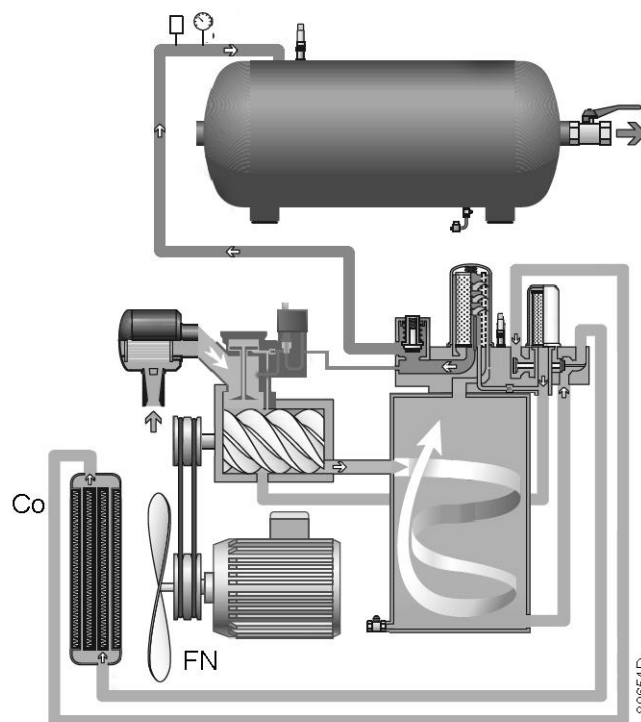

*Cooling system*

The cooling system comprises oil cooler (Co) and fan (FN). The fan, mounted directly onto the motor shaft, generates the cooling air in order to cool the oil and the internal parts of the compressor.

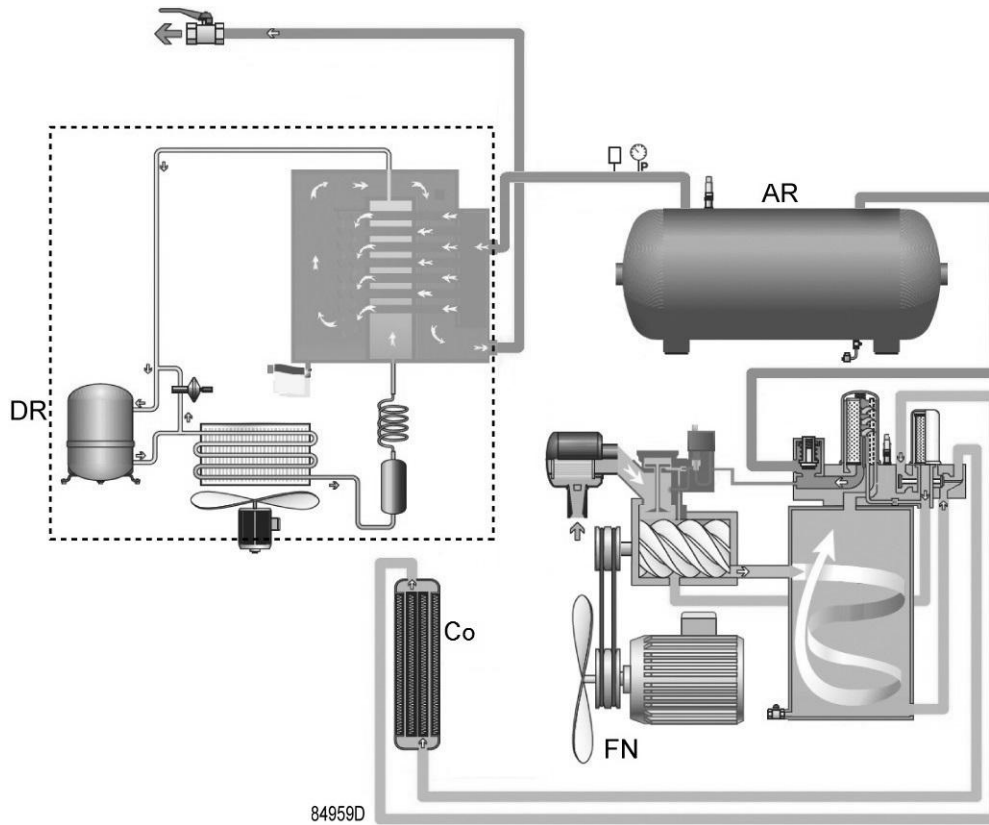

*Cooling system, units with dryer*

The cooling system of the version with dryer comprises oil cooler (Co), air receiver (AR) and fan (FN).

The dryer (DR) has a separate cooling fan and an automatic condensate drain (see also section [Air dryer](#)).

## 2.5 Regulating system

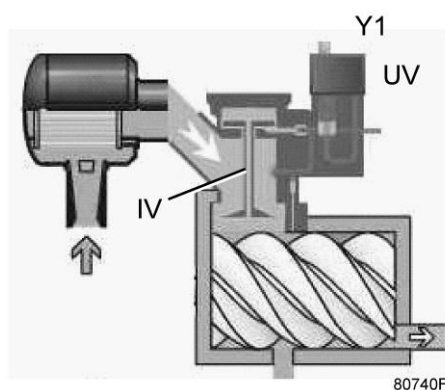

*Detail view of unloader assembly (UA)*

The main components of the regulating system are:

- Unloader (UA), including inlet valve (IV) and unloading valve (UV).
- Loading solenoid valve (Y1).
- The controller that regulates the compressor based on the pressure settings and readings of the pressure sensor.

## Loading

As long as the working pressure is below the preset maximum, the solenoid valve is energised, allowing control air to the unloader: the inlet valve opens completely and the unloading valve closes completely. The compressor will run fully loaded (100% output).

Anticipated restart algorithm:

The unit stops loaded, because the set 'Unload' pressure is reached. The controller will anticipate the restart 0,2 bar before reaching the set 'Load' pressure to avoid a restarting delay. Otherwise this may result in a restarting pressure lower than the set 'Load' pressure.

## Unloading

When the working pressure reaches the maximum limit, the solenoid valve is de-energised, venting the control air: the inlet valve closes completely and the unloading valve opens completely. The compressor will run unloaded (0% output).

The compressors are equipped with an intelligent controller that will stop the compressor after a variable period of unloaded operation using following control algorithm:

- At power on, in the first work cycle, the 'Unload' period is 30 seconds.
- After the first work cycle, and in all other working cycles, the 'Unload' period is calculated following 3 rules:
  - a. Given a max number of 10 restarts per hour (factory setting), the total running period per cycle ('Load' time + 'Unload' time) must be minimum 6 minutes (360s).
  - b. At the end of the unload period the controller checks the air consumption and decides whether to stop the unit or restart to anticipate the air demand.
  - c. Motor virtual temperature calculation.  
If the unit is restarting frequently, or is manually restarted by the operator, the controller will extend the unload period in order to ensure proper motor cooling. This point overrules point the standard unload period.

The compressor will automatically restart when the net pressure drops to the minimum limit.

## 2.6 Control panel

## Control panel

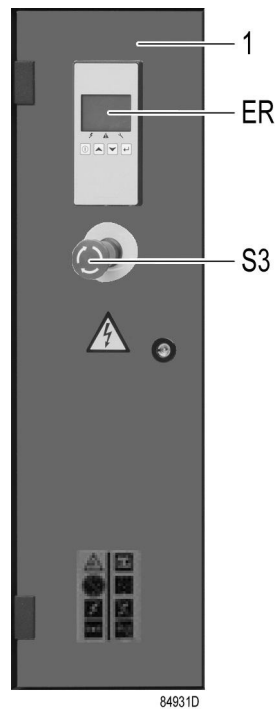

Control panel

| Reference | Designation              |
|-----------|--------------------------|
| 1         | Electric cabinet         |
| ER        | ES 4000 Basic Controller |
| S3        | Emergency stop button    |

## 2.7 Electrical system

### Electrical components

The electrical system comprises following components:

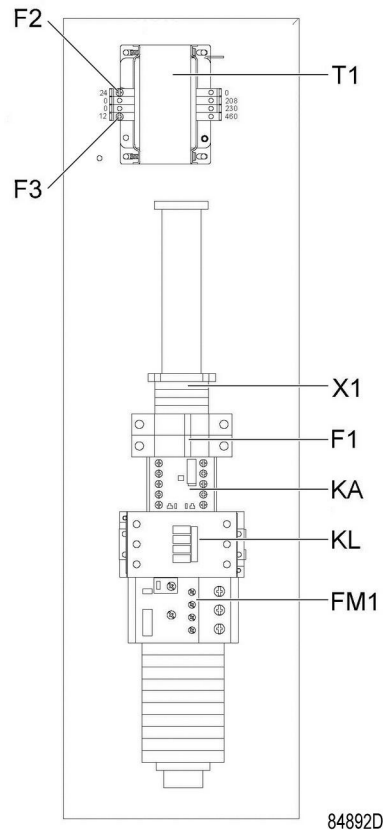

*Electric cubicle UL (DOL)*

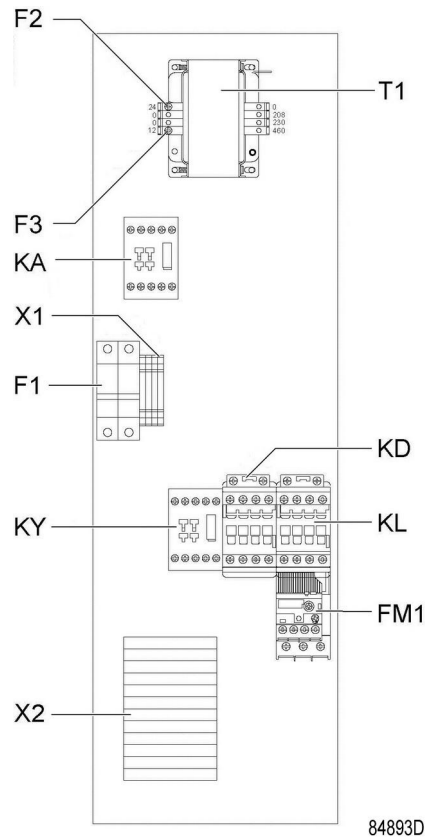

Electric cubicle UL(YD)

| Reference | Designation   |
|-----------|---|
| F1        | Primary fuse, transformer of the control circuit                        |
| F2-3      | Fuses   |
| FM1       | Motor overload relay  |
| KA        | Auxiliary circuit relay   |
| KD        | Delta contactor   |
| KL        | Line contactor  |
| KY        | Star contactor  |
| T1        | Transformer   |
| X1        | Terminal block of the control circuit                                   |
| X2        | Terminal block, voltage change of the motor (Only on tri-voltage units) |

### Electrical diagram

|              |  |
|--------------|--|
| 2205 0315 60 | Service diagram cULus/ cCSAus (DOL) for 10 and 15 hp |
| 2205 0316 30 | Service diagram cULus/ cCSAus (YD) for 20 hp         |

The complete electrical diagram can be found in the electric cubicle.

The complete electrical diagram can be found on the CD supplied with the machine.



## 2.8 Protection of the compressor



SV

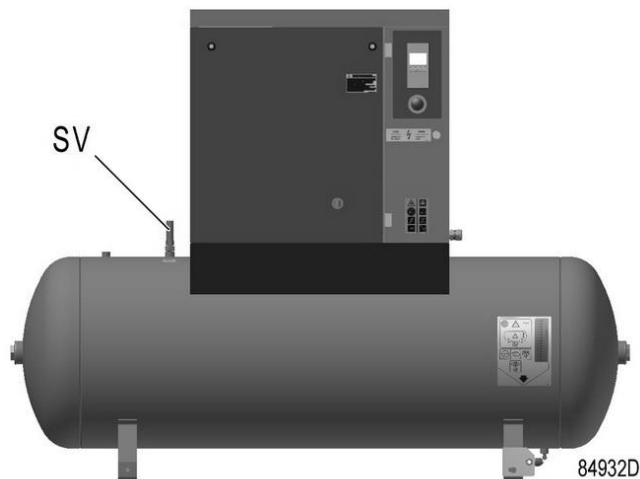

84932D

*Safety valve on the compressor and on the vessel*

| Reference | Designation  | Function   |
|-----------|--------------|--|
| SV        | Safety valve | To protect the air outlet system if the outlet pressure exceeds the opening pressure of the valve. |

## 2.9 Air dryer

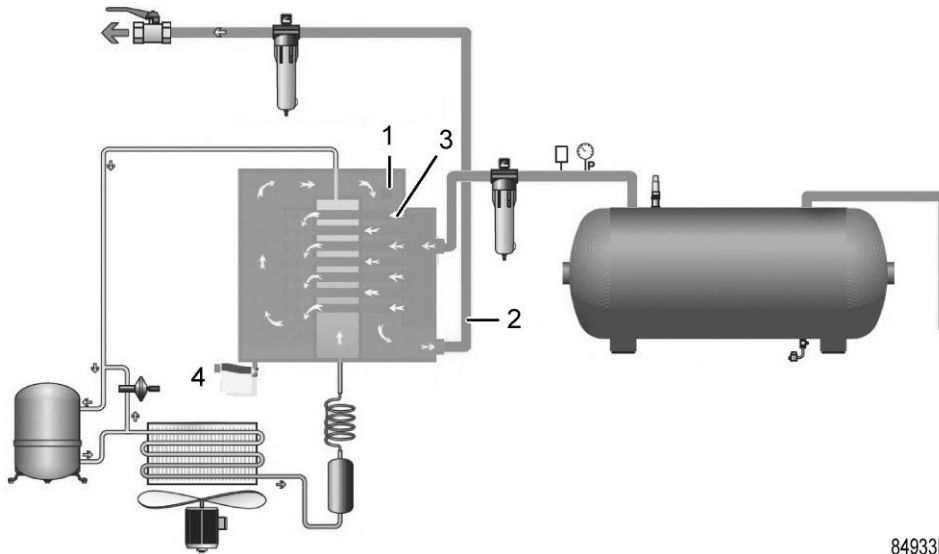

84933D

*Air Dryer*

Wet compressed air enters the dryer and is further cooled by the outgoing, dried air (2). Moisture in the incoming air condenses. The air then flows through heat exchanger (1) where refrigerant evaporates, withdrawing heat from the air. The cold air then flows through condensate trap (4) which separates condensate from the air. The condensate is automatically drained. The cold, dried air then flows through heat exchanger (3), where it is warmed up by the incoming air.

## 3 Controller

### 3.1 Controller

#### Control panel

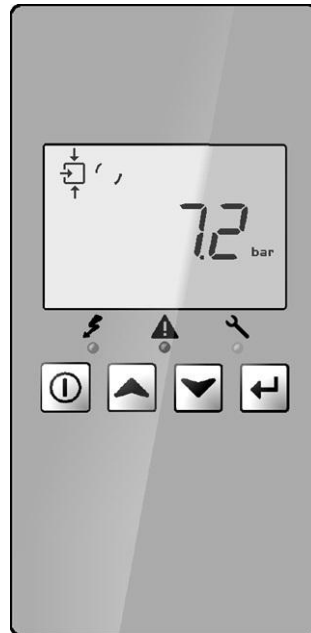

84891D

#### Introduction

**In general, the controller has following functions:**

- Controlling the compressor;
- Protecting the compressor;
- Monitoring service intervals;
- Automatic restart after voltage failure (made inactive);

#### Automatic control of the compressor

The controller maintains the net pressure between programmable limits by automatically loading and unloading the compressor. A number of programmable settings, e.g. the unloading and loading pressures, the minimum stop time and the maximum number of motor starts are taken into account.

The controller stops the compressor whenever possible to reduce the power consumption and restarts it automatically when the net pressure decreases. If the expected unloading period is too short, the compressor is kept running to prevent too short standstill periods.

#### Protecting the compressor

##### Shutdown temperature warning

The shutdown temperature warning is a programmable warning that advises the operator that the shutdown temperature is nearly reached. If the measured temperature exceeds the programmed

shutdown warning temperature, this will be indicated on the controller display before the shutdown temperature is reached.

**Shutdown**

If the compressor element outlet temperature exceeds the programmed shutdown level or the overload relay of the main motor trips, the compressor will be stopped. This will be indicated on the display of the controller.

**Service warning**

If the service timer exceeds the preset value, the controller advises the operator via the display, to carry out the service maintenance.

**Automatic restart after voltage failure**

The controller has a built-in function to automatically restart the compressor when the voltage is restored after voltage failure. This function is deactivated on compressors leaving the factory.



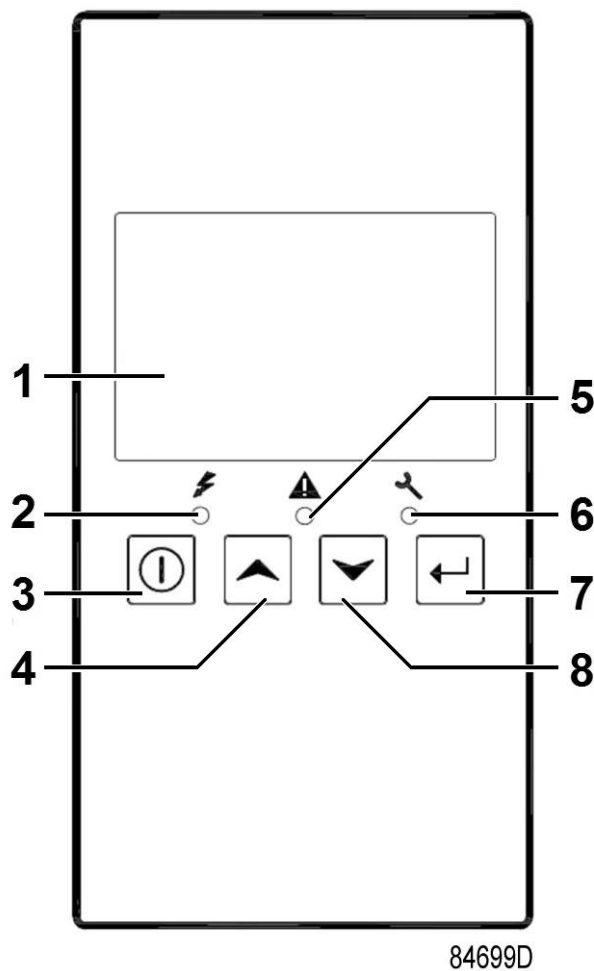



**3.2 Control panel**



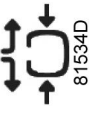
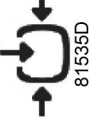

| Reference | Designation | Function                              |
|-----------|-------------|---------------------------------------|
| 1         | Display     | Shows icons and operating conditions. |

| Reference | Designation       | Function  |
|-----------|-------------------|---|
| 2         | LED, Voltage on   | Indicates that the voltage is switched on.  |
| 3         | Start/stop button | Keep pressed for 3 seconds to start compressor.<br>Press to stop compressor if running.<br>Use this button to go to previous screen or to end the current action. |
| 4         | Scroll button     | Use these buttons to scroll through the menu.   |
| 5         | LED, Warning      | Is lit if a warning condition exists.   |
| 6         | LED, Service      | Is lit when service is needed.  |
| 7         | Enter button      | Press 3 seconds to enter in menu.<br>Use this button to confirm the last action.<br>Press 5 seconds to reset alarm.   |
| 8         | Scroll button     | Use these buttons to scroll through the menu.   |

### 3.3 Icons used on the display

| Function                                | Icon   | Description   |
|---|--|---|
| Stopped/Running                         |  81532D  | When the compressor is stopped, the icon stands still.<br>When the compressor is running, the icon is rotating. |
| Compressor status                       |  81533D | Motor stopped   |
|   |  81534D | Running unloaded<br>Running unloaded (blinking for manual stop)   |
|   |  81535D | Running loaded  |
| Machine control mode                    |  81536D | Remote start/stop active  |
| Automatic restart after voltage failure |  81538D | Automatic restart after voltage failure is active   |
| Active protection functions             |  81540D | Emergency stop  |
| Service                                 |  81541D | Service required  |

| Function | Icon   | Description  |
|----------|--|--|
| Units    | <b>MPa</b><br>81116D   | Pressure unit (Mega Pascal)  |
|          | <b>psi</b><br>81115D   | Pressure unit (pounds per square inch)   |
|          | <b>bar</b><br>81114D   | Pressure unit (bar)  |
|          | <b>°C</b><br>81108D  | Temperature unit (degree Centigrade)   |
|          | <b>°F</b><br>81107D  | Temperature unit (degree Fahrenheit)   |
|          | <br>81542D                  | Motor  |
|          |  <b>x1000 hrs</b><br>84700D | A time/delay parameter is displayed. NOTE: <ul style="list-style-type: none"> <li>• x1000: ON if the displayed value is in thousands of</li> <li>• hrs: ON if the displayed value is in hours</li> <li>• s: ON if the displayed value is in seconds</li> </ul> |
|          | <br>81543D                | Element outlet temperature   |

### 3.4 Main screen

At power on, the first screen is a test screen (Icon, digit and led are on). The next screen is the Main screen, shown automatically. The Main screen shows:

- The compressor status by means of pictographs;
- The air outlet pressure;

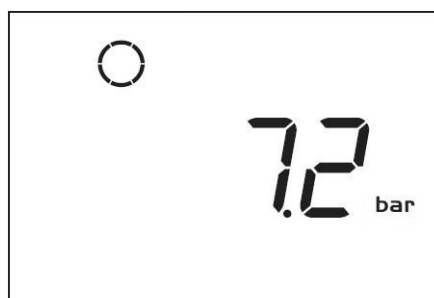

84702D

*Main screen with pressure (stopped compressor)*

From the Main screen it is possible with up and down buttons (4-8) to change the view from pressure to temperature of the element outlet.

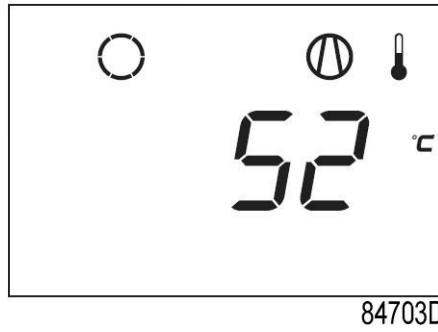

*Main screen with temperature (stopped compressor)*

### 3.5 Main function

To switch on the compressor, press start/stop button (3) for 3 seconds. The compressor starts and the status is shown:

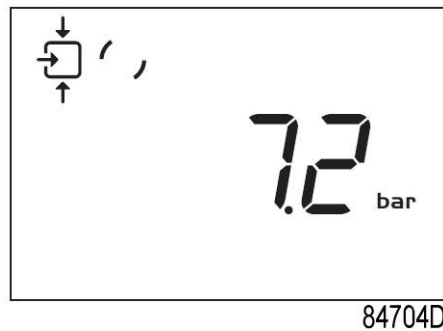

*Screen with running compressor*

To stop the compressor, push start/stop button (3). The compressor unloads:

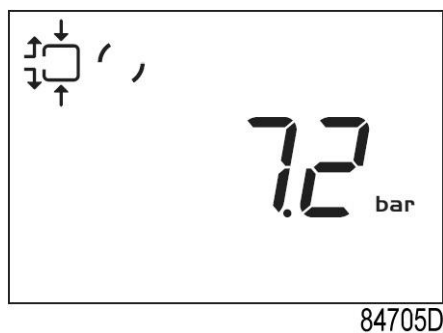

*Screen with unloading compressor*

When the unload time is elapsed, the compressor is stopped and the controller goes back to main screen:

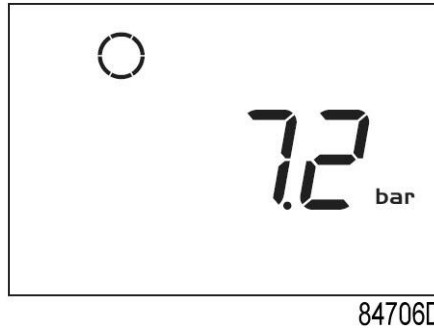

*Main screen with pressure (stopped compressor)*

To enter the main menu (starting from the Main screen), press the enter button (7) for 3 seconds. The main menu is shown:



*First screen of main menu*

It is possible to scroll in the menu with the up or down buttons (4-8). To select one item push the enter button (7). To end the current action push start/stop (3) button.

If the emergency stop button is pushed, the compressor stops immediately and the following screen will appear:



*Emergency stop*

When the emergency push button is restored, reset the alarm by pressing the enter button (7) for 5 seconds. The following screen will appear:



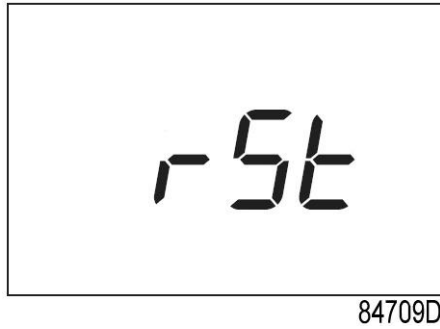

*Alarm reset*

## 3.6 Shutdown warning

### Description

**A shutdown warning will appear in the event of:**

- A too high temperature at the outlet of the compressor element.

### Compressor element outlet temperature

- If the outlet temperature of the compressor element exceeds the shutdown warning level (factory set at 110°C/ 230°F), warning LED (5) is on.
- Press Scroll up or down buttons (4-8). The screen shows the temperature at the compressor element outlet.

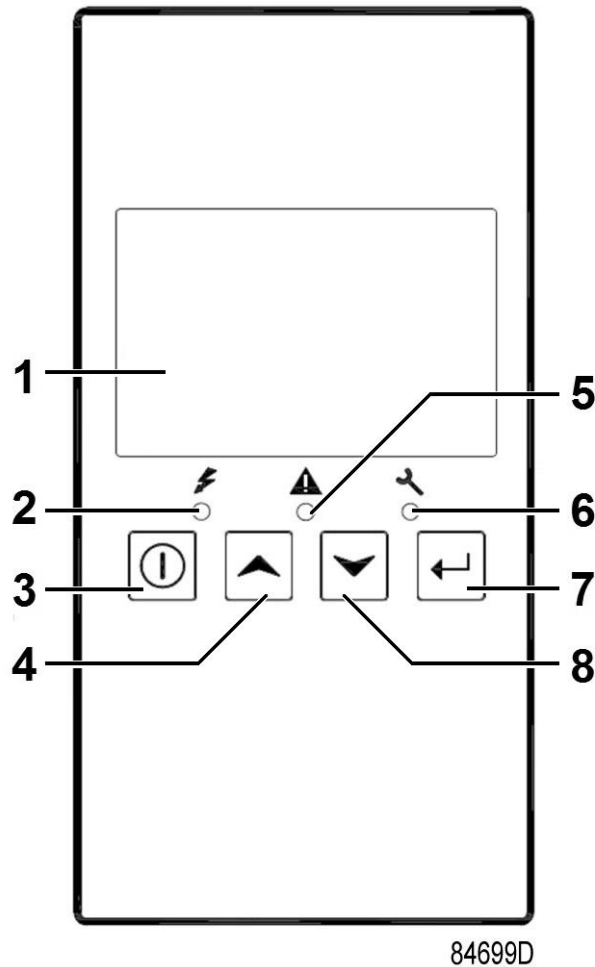

It remains possible to check the actual status of other parameters by pressing the enter button (7) for 3 seconds. Press button (3) to stop the compressor and wait until the compressor has stopped. The warning message will disappear as soon as the warning condition disappears.

## 3.7 Shutdown

### Description

#### The compressor will stop:

- In case the temperature at the outlet of the compressor element exceeds the shutdown level (detected by temperature sensor (TT11) or by temperature switch (TSHH11)).
- In case of error of the outlet pressure sensor (PT20) or temperature sensor (TT11).
- In case of overload of the compressor motor (M1)

#### Compressor element outlet temperature

If the outlet temperature of the compressor element exceeds the shutdown level (factory setting 115°C/239°F):

- The compressor will stop.
- Alarm LED (5) will flash.
- The following screen will appear:

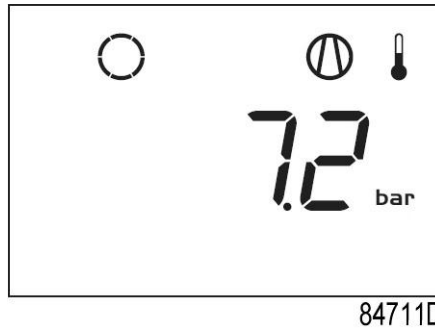

*Main screen with shutdown indication, element outlet temperature*

- The related pictograph



will appear flashing.

- Scroll Up or Down buttons (4-8) until the current element outlet temperature appears.

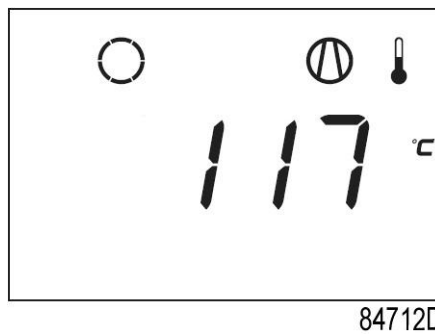

*Shutdown screen, element outlet temperature*

The screen shows that the temperature at the outlet of the compressor element is 117 °C.

- When the shutdown condition has been solved, press the Enter button (7) for 5 seconds.
- When <rSt> appears on the display, the compressor can be restarted.

### **Motor overload**

In the event of motor overload:

- The compressor will stop.
- Alarm LED (5) will flash.
- The following screen will appear:

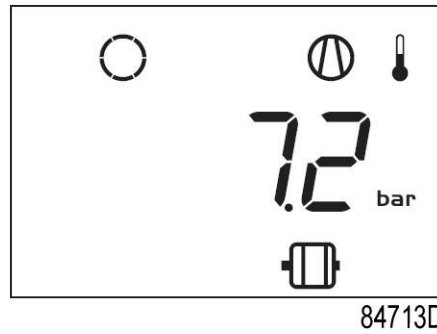

*Main screen with shutdown indication, motor overload*

- Contact your supplier for fault troubleshooting
- When the shutdown condition has been solved, press the enter button (7) for 5 seconds.
- When <rSt> appears on the display, the compressor can be restarted.

### **Error pressure/temperature sensor**

In the event of an error of the outlet pressure sensor (PT20) or temperature sensor (TT11):

- The compressor will stop.
- The following screen will appear:

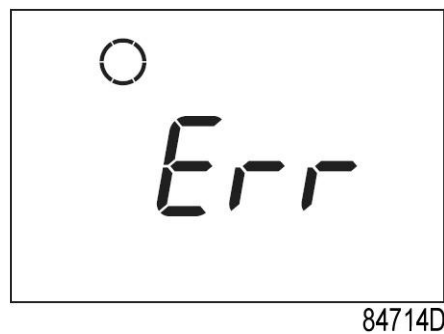

*Example of error sensor*

## **3.8 Service warning**

### **Description**

A service warning will appear when the service timer has reached the preset time interval.

If the service timer exceeds the programmed time interval, alarm LED (6) is blinking with a following screen:

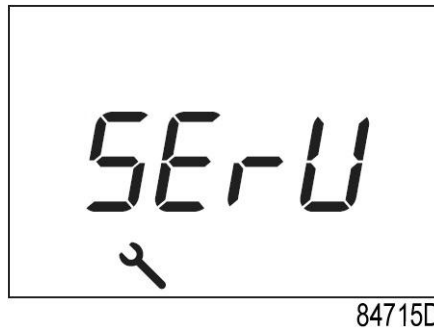

*Blinking screen*

- Press Enter button (7) to enter the main menu.
- Select <dAtA> and press Enter button (7) to enter the data menu.
- Scroll (buttons 4-8) until <d.6> and the service symbol is shown.
- Press enter button (7).
- The actual reading of the service timer is shown in <hrs>.



*Example of running hours screen*

The example screen shows that the service timer is at 2002 hours.

Stop the compressor, switch off the voltage and carry out the required service actions.

After servicing, reset the service timer.

See section [Calling up/resetting the service timer](#).

### 3.9 Scrolling through all screens

#### Control panel

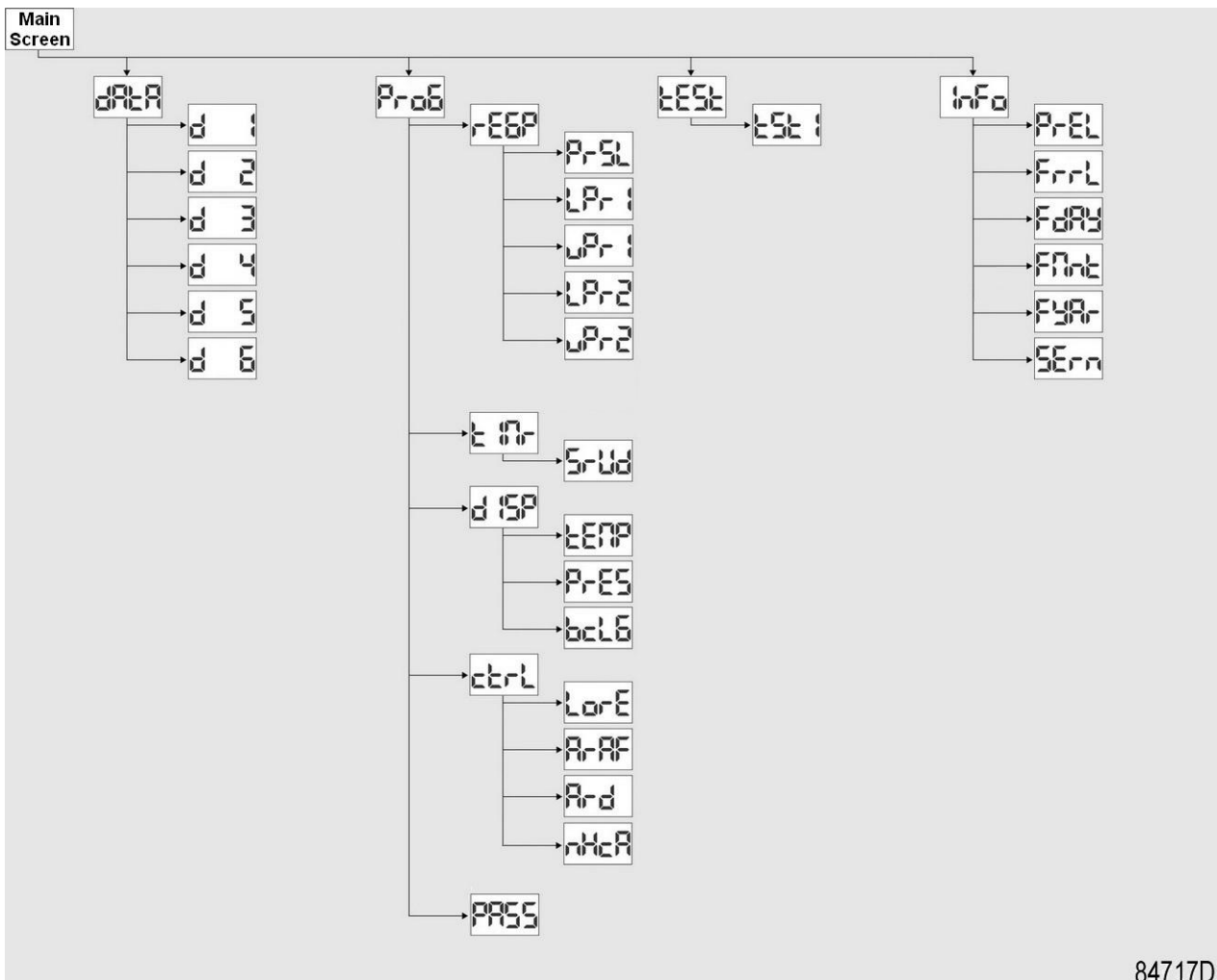

General overview of the menu structure

From the Main screen press the enter button (7) for 3 seconds to enter the Menu. You will find the following items:

|             |   |
|-------------|---|
| <b>dAtA</b> | Data counters parameters.   |
| <b>ProG</b> | Submenu of Regulation pressure, Timer, Display setting and Control setting. |
| <b>tEst</b> | Display test.   |
| <b>InFo</b> | Information of firmware release.  |

### Overview of the screens

| Menu item               | Submenu                          | Digital input screen | Designation   |
|-------------------------|----------------------------------|----------------------|---|
| <dAtA><br>(Data)        |                                  | <d.1>                | Calling up running hours.   |
|                         |                                  | <d.2>                | Calling up motor starts.  |
|                         |                                  | <d.3>                | Calling up module hours.  |
|                         |                                  | <d.4>                | Calling up loading hours.   |
|                         |                                  | <d.5>                | Calling up load solenoid valve.                                   |
|                         |                                  | <d.6>                | Calling up service timer.   |
| <ProG><br>(Programming) | <rEG.P><br>(Regulation Pressure) | <Pr.SL>              | Calling up or modifying pressure band selection.                  |
|                         |                                  | <LPr.1>              | Calling up or modifying lower pressure setting.                   |
|                         |                                  | <uPr.1>              | Calling up or modifying upper pressure setting.                   |
|                         |                                  | <LPr.2>              | Calling up or modifying lower pressure setting.                   |
|                         |                                  | <uPr.2>              | Calling up or modifying upper pressure setting.                   |
|                         | <tiMr><br>Timer                  | <SrV.d>              | Calling up maintenance warning.                                   |
|                         | <diSP><br>(Display)              | <tEMP>               | Calling up or modifying unit of temperature.                      |
|                         |                                  | <PrES>               | Calling up or modifying unit of pressure.                         |
|                         |                                  | <bC.LG>              | Calling up or modifying time of backlight.                        |
|                         | <Ctrl><br>(Control)              | <Lo.rE>              | Calling up local/remote start/stop.                               |
|                         |                                  | <Ar.Af>              | Calling up automatic restart after voltage failure.               |
|                         |                                  | <Ar.d>               | Calling up delay time of automatic restart after voltage failure. |
|                         |                                  | <nHCA>               | Calling up the maximum number of compressor starts per hour.      |
|                         | <PASS>                           |                      | Activating password protection.                                   |
|                         | <tESt><br>(Test)                 |                      | <tSt.1>   |
| <InFo><br>(Info)        |                                  | <P.rEL>              | Parameter map release.  |
|                         |                                  | <F.rRI>              | Firmware release.   |
|                         |                                  | <F.dAY>              | Firmware release day.   |
|                         |                                  | <F.Mnt>              | Firmware release month.   |
|                         |                                  | <F.YAr>              | Firmware release year.  |
|                         |                                  | <SEr.n>              | Serial number.  |

## 3.10 Calling up running hours

Starting from the Main screen:

- Press Enter button (7) for 3 seconds to enter the Main menu.

- Select <dAtA> and press Enter button (7) to enter the Data menu.
- Scroll Up or Down buttons (4-8) until <d.1> and the motor stopped symbol is shown.
- Press Enter button (7): the running hours are shown.

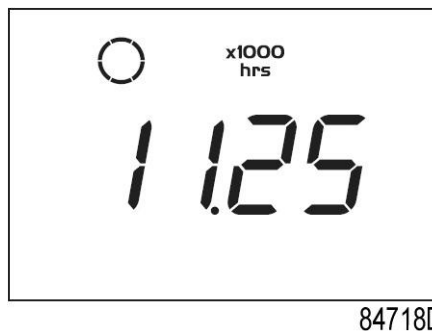

The screen shows the unit used <x1000 hrs> and the value <11.25>: the running hours of the compressor are 11250 hours.

### 3.11 Calling up motor starts

Starting from the Main screen:

- Press Enter button (7) for 3 seconds to enter the Main menu.
- Select <dAtA> and press Enter button (7) to enter the Data menu.
- Scroll Up or Down buttons (4-8) until <d.2> and the motor symbol is shown.
- Press Enter button (7): the number of motor starts is shown.

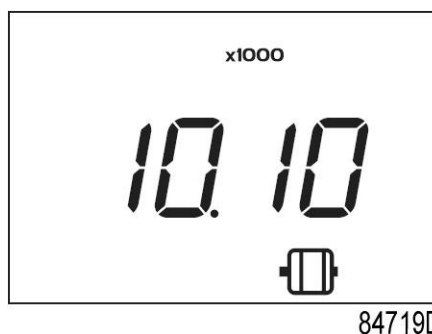

This screen shows the number of motor starts (x1 or - if <x1000> lights up - x1000). In the above example, the number of motor starts is 10100.

### 3.12 Calling up module hours

Starting from the Main screen:

- Press Enter button (7) for 3 seconds to enter the Main menu.
- Select <dAtA> and press Enter button (7) to enter the Data menu.
- Scroll Up or Down buttons (4-8) until <d.3> and <hrs> is shown.
- Press Enter button (7): the module time appears.





In the example shown, the screen shows the unit used <hrs> and the value <5000>: the controller module has been in service during 5000 hours.

### 3.13 Calling up loading hours

Starting from the Main screen:

- Press Enter button (7) for 3 seconds to enter the Main menu.
- Select <dAtA> and press Enter button (7) to enter the Data menu.
- Scroll Up or Down buttons (4-8) until <d.4> and the running loaded symbol is shown.
- Press Enter button (7): the loading time is shown.

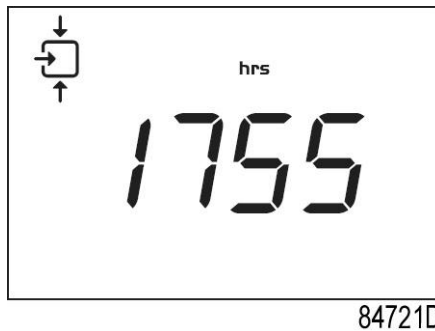

The screen shows the unit used <hrs> (or <x1000 hrs>) and the value <1755>: the compressor has been running loaded during 1755 hours.

### 3.14 Calling up load solenoid valve

Starting from the Main screen:

- Press Enter button (7) for 3 seconds to enter the Main menu.
- Select <dAtA> and press Enter button (7) to enter the Data menu.
- Scroll Up or Down buttons (4-8) until <d.5> and the running loaded symbol is shown.
- Press Enter button (7): the number of loadings is shown.

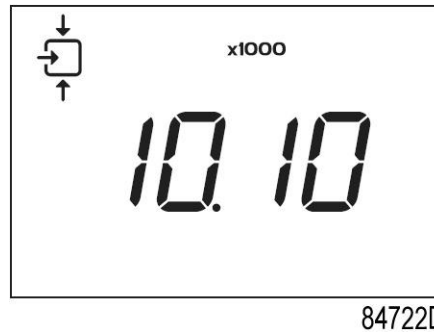

This screen shows the number of loading actions (x1 or - if <x1000> lights up - x1000). In the above example, the number of unload to load actions is 10100.

### 3.15 Calling up/resetting the service timer

Starting from the Main screen:

- Press Enter button (7) for 3 seconds to enter the Main menu.
- Select <dAtA> and press Enter button (7) to enter the Data menu.
- Scroll Up or Down buttons (4-8) until <d.6> and <hrs> is shown.
- Press Enter button (7): the service timer is shown.



This screen shows the unit used (<hrs> or <x1000 hrs>) and the value. In the example shown, the compressor has run 1191 hours since the previous service.

### 3.16 Calling up/modifying pressure band selection

Starting from the Main screen:

- Press Enter button (7) for 3 seconds to enter the Main menu.
- Select <ProG> and press Enter button (7) to enter the Programming menu.
- After <PASS> blinking, confirm <0> with Enter button (7).
- Scroll Up or Down buttons (4-8) to <reG.P> for regulation pressure.
- Press Enter button (7) to enter the submenu.

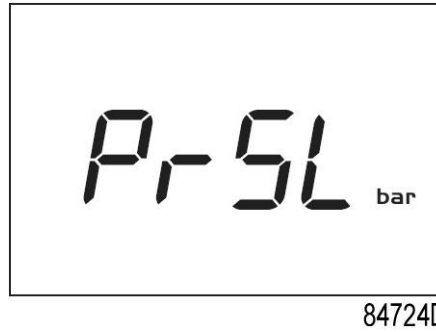

- Scroll Up or Down buttons (4-8) until <PrSL> is shown and then press Enter button (7).
- Pressure band 1 (<SEL.1>) is shown. Scroll Up or Down buttons (4-8) to pressure band 2 (<SEL.2>).
- Press Enter button (7) on the desired pressure band.

### 3.17 Calling up/modifying pressure band settings

Starting from the Main screen:

- Press Enter button (7) for 3 seconds to enter the Main menu.
- Select <ProG> and press Enter button (7) to enter the Programming menu.
- After <PASS> blinking, confirm <0> with Enter button (7).
- Scroll Up or Down buttons (4-8) to <reG.P> for regulation pressure.
- Press Enter button (7) to enter the submenu.

<LPr.1> is parameter of Load Pressure band 1

<uPr.1> is parameter of Unload Pressure band 1

<LPr.2> is parameter of Load Pressure band 2

<uPr.2> is parameter of Unload Pressure band 2

- Scroll Up or Down buttons (4-8) and press Enter button (7) to select parameter.
- The actually used pressure is shown. Scroll Up or Down buttons (4-8) to set pressure value and press Enter button (7) to confirm. The unit blinks and the new setting is saved.

### 3.18 Calling up/modifying the unit of temperature

The unit of temperature measurement can only be changed when the compressor is stopped.

Starting from the Main screen:

- Press Enter button (7) for 3 seconds to enter the Main menu.
- Select <ProG> and press Enter button (7) to enter the Programming menu.
- After <PASS> blinking, confirm <0> with Enter button (7).
- Scroll Up or Down buttons (4-8) to <diSp> for display settings.
- Press Enter button (7) to enter the submenu.
- Scroll Up or Down buttons (4-8) to <tEMP> and press Enter button (7).
- The actually used unit is shown. Possible settings are <°C > and <°F >.
- Scroll Up or Down buttons (4-8) to set the unit of temperature and press Enter button (7) to confirm. The unit blinks and is saved.

### 3.19 Calling up/modifying the unit of pressure

The unit of pressure measurement can only be changed when the compressor is stopped.

Starting from the Main screen:

- Press Enter button (7) for 3 seconds to enter the Main menu.
- Select <ProG> and press Enter button (7) to enter the Programming menu.
- After <PASS> blinking, confirm <0> with Enter button (7).
- Scroll Up or Down buttons (4-8) to <diSp> for display settings.
- Press Enter button (7) to enter the submenu.
- Scroll Up or Down buttons (4-8) to <PrES> and press Enter button (7).
- The actually used unit is shown. Possible settings are <bar>, <psi> and <MPa>.
- Scroll Up or Down buttons (4-8) to set the unit of pressure and press Enter button (7) to confirm. The unit blinks and is saved.

### 3.20 Calling up/modifying backlight time

The backlight will be activated after pressing any button and for the interval of time set in the parameter <bC.LG> (in sec).

Starting from the Main screen:

- Press Enter button (7) for 3 seconds to enter the Main menu.
- Select <ProG> and press Enter button (7) to enter the Programming menu.
- After <PASS> blinking, confirm <0> with Enter button (7).
- Scroll Up or Down buttons (4-8) to <diSp> for display settings.
- Press Enter button (7) to enter the submenu.
- Scroll Up or Down buttons (4-8) to <bC.LG> and press Enter button (7).
- The current backlight setting is shown. It is possible to set a value between 0s and 120s.
- Scroll Up or Down buttons (4-8) to set the time of backlight and press Enter button (7) to confirm. The unit blinks and is saved.

### 3.21 Activating automatic restart after voltage failure

#### Description

This function allows the compressor to restart automatically after voltage failure. The activation can only be done by your supplier. Please contact him for further details.

After any power failure, before restarting, the compressor will wait for a fixed time. When delay time is running, the display will show the related countdown value (in seconds) as below:

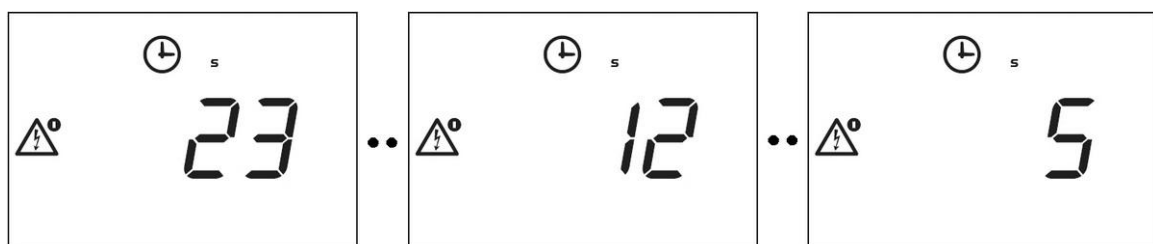

84725D

*Example countdown delay time of automatic restart after power failure.*

## 3.22 Keyboard lock

Keep both Up and Down buttons pressed for more than 3 seconds to lock or unlock the keyboard.

- The display will show the label <Loc> blinking for 3 seconds if the keyboard has been locked.
- The display will show the label <UnLo> blinking for 3 seconds if the keyboard has been unlocked.

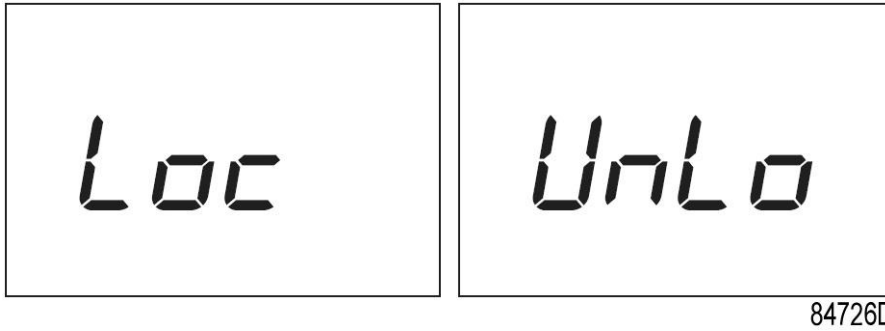

*Example Lock/unlock screen.*

## 4 Installation

### 4.1 Installation proposal

#### Outdoor/altitude operation

If the compressor is installed outdoors or if the ambient temperature can be below 0°C (32°F), precautions must be taken. In this case, and also if operating at high altitude, consult your supplier.

#### Moving/lifting

The lifting bars are available as an option.



84948D

*Transport by a pallet truck*



For transport with a fork truck, use the openings in the frame.  
Move the compressor gently.

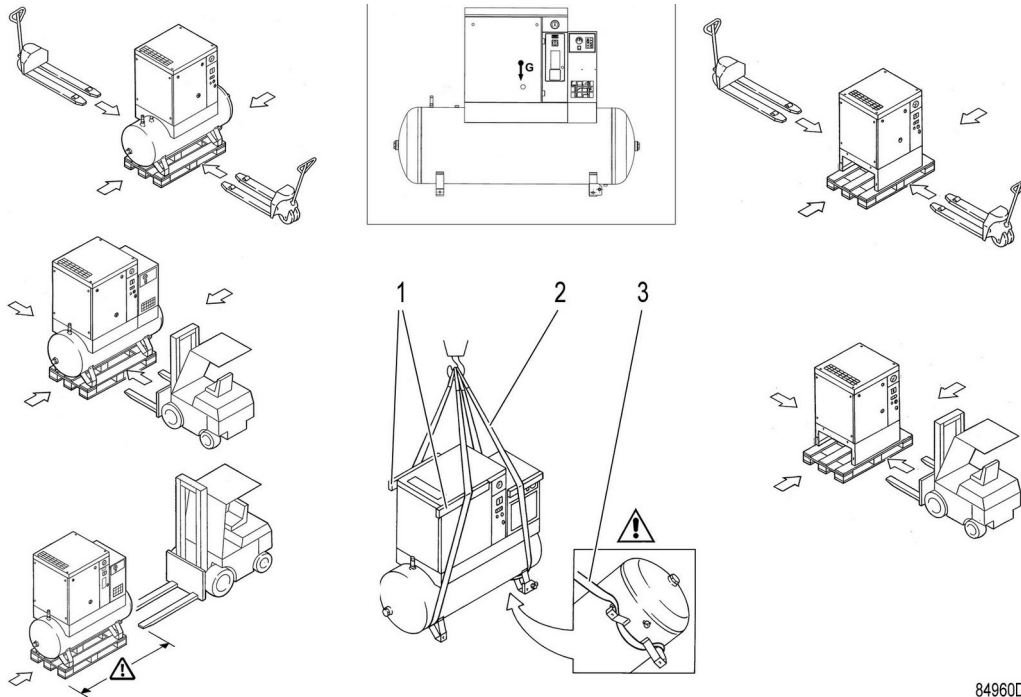

84960D

*Lifting instructions*

| Reference | Designation   |
|-----------|---|
| 1         | Spacer bars to protect the body.  |
| 2         | Lifting straps: <ul style="list-style-type: none"> <li>• Minimum length: 6 meter</li> <li>• ISO 4878</li> </ul> |
| 3         | It is recommended to position the lifting straps this way.  |

### Installation proposal

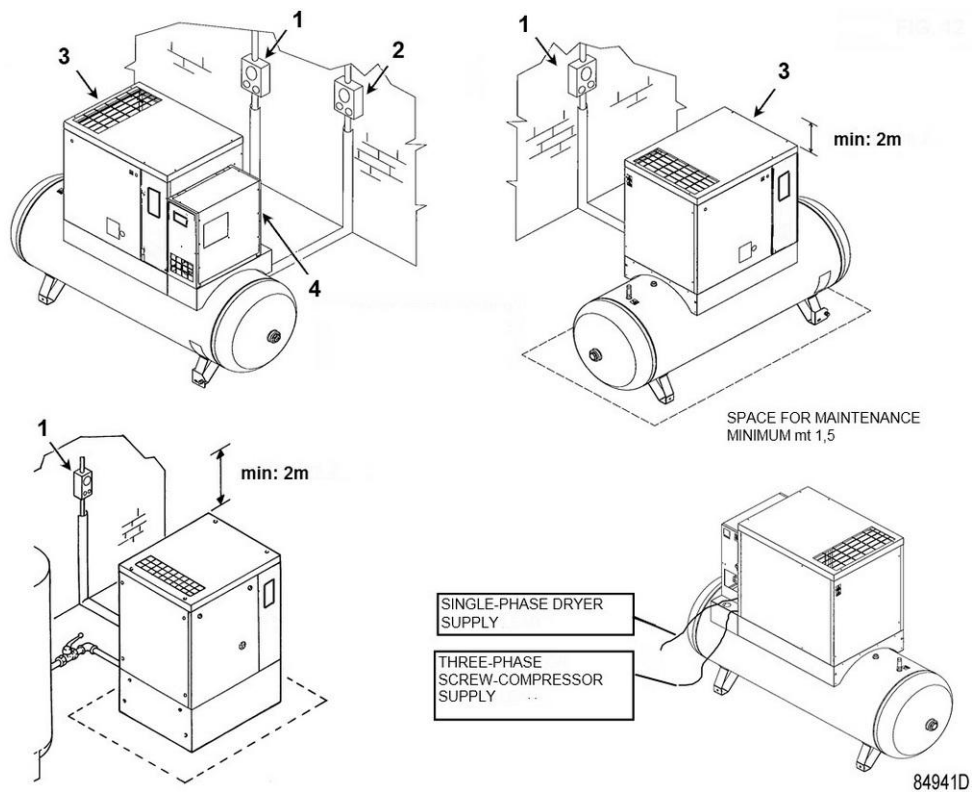

Installation proposal

| Ref. | Action   |
|------|--|
| 1    | Main power switch for the compressor (three-phase).<br>Power supply cables need to be protected by suitable conduit.   |
| 2    | Main power switch for the dryer (single-phase).<br>Power supply cables need to be protected by suitable conduit.   |
| 3    | Install the compressor on a solid, level floor suitable for taking its weight.<br>The recommended minimum distance between the top of the unit and the ceiling is 2 m (78.7 in).<br>The air receiver must not be bolted to the floor.<br>For tank-mounted units, the minimum distance between the wall and the back of the compressor is 1.5 m (59 in).  |
| 4    | Position of the dryer.   |
|      | The pressure drop over the air delivery pipe can be calculated as follows:<br>$\Delta p = (L \times 450 \times Q_c^{1.85}) / (d^5 \times P)$ , with<br>d = Inner diameter of the pipe in mm<br>$\Delta p$ = Pressure drop in bar (recommended maximum: 0.1 bar (1.5 psi))<br>L = Length of the pipe in m<br>P = Absolute pressure at the compressor outlet in bar<br>Q <sub>c</sub> = Free air delivery of the compressor in l/s |



| Ref. | Action   |
|------|--|
|      | <p>Ventilation: the inlet grids and ventilation fan should be installed in such a way that any recirculation of cooling air to the compressor or dryer is avoided.<br/>                     The air velocity to the grids must be limited to 5 m/s (200 in/s).<br/>                     The required ventilation capacity to limit the temperature of the compressor room can be calculated from the following formula:<br/> <math>Q_v = 0.92 N / \Delta T</math><br/> <math>Q_v</math> = Required ventilation capacity in m<sup>3</sup>/s<br/>                     N = Shaft input of compressor in kW<br/> <math>\Delta T</math> = Temperature increase in the compressor room in °C</p> |

## 4.2 Dimension drawings

The dimension drawing can be found on the CD-ROM, DVD or USB, supplied with the unit.

| Dimension drawing | Model                   |
|-------------------|-------------------------|
| 9828 0832 60      | Floor mounted           |
| 9828 0832 61      | Tank mounted            |
| 9828 0832 62      | Tank mounted with dryer |

| Text on drawings                           | Translation or explanation                 |
|--|--|
| Emergency stop switch                      | Emergency stop switch                      |
| Power supply                               | Power supply                               |
| Cooling air and compressor inlet           | Cooling air and compressor inlet           |
| Cooling air outlet of compressor and motor | Cooling air outlet of compressor and motor |
| Service panel                              | Service panel                              |
| Compressor controller                      | Compressor controller                      |
| Oil level indicator                        | Oil level indicator                        |
| Compressed air outlet (G1/2" Female)       | Compressed air outlet                      |
| Forklift openings                          | Forklift openings                          |
| Valve rotation                             | Valve rotation                             |
| Centre of gravity                          | Centre of gravity                          |
| Cubicle door fully open                    | Cubicle door fully open                    |
| Anchorpoints in base                       | Anchorpoints in base                       |
| Air receiver safety valve                  | Air receiver safety valve                  |
| Vessel anchor points                       | Vessel anchor points                       |
| Air receiver manual drain (G3/8" Female)   | Air receiver manual drain                  |
| Dryer dewpoint indicator                   | Dryer dewpoint indicator                   |
| Condensate drain integrated dryer          | Condensate drain integrated dryer          |
| Dryer inlet cooling air                    | Dryer inlet cooling air                    |
| Dryer outlet cooling air                   | Dryer outlet cooling air                   |

## 4.3 Electrical connections



Always disconnect the power supply before working on the electrical circuit!

### General instructions

| Step | Action   |
|------|--|
| 1    | Install an isolating switch near the compressor.   |
| 2    | Check the fuses and the setting of overload relay. See <a href="#">Settings for overload relay and fuses</a> .   |
| 3    | If fitted, check transformers for correct connection.  |
| 4    | Connect the power supply cables to terminals L1, L2 and L3 (1X0) and the neutral conductor (if applicable) to terminal (N). Connect the earth conductor.<br>The power supply cable delivered with the compressor must be protected by raceway or by a suitable conduit system. |

### Specific voltage change instructions for units with 208 V / 230 V / 460 V cubicle

The standard voltage configuration for the compressor is mentioned on the data plate of the machine.

When the compressors leave the factory, the units are connected for 230 V / 3 phase.

To modify the wiring for an operating voltage of 208 V or 460 V, the main cubicle should be rewired as described below:

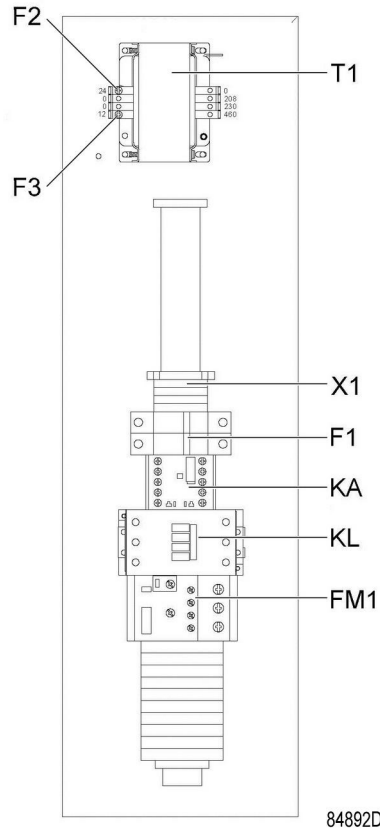

84892D

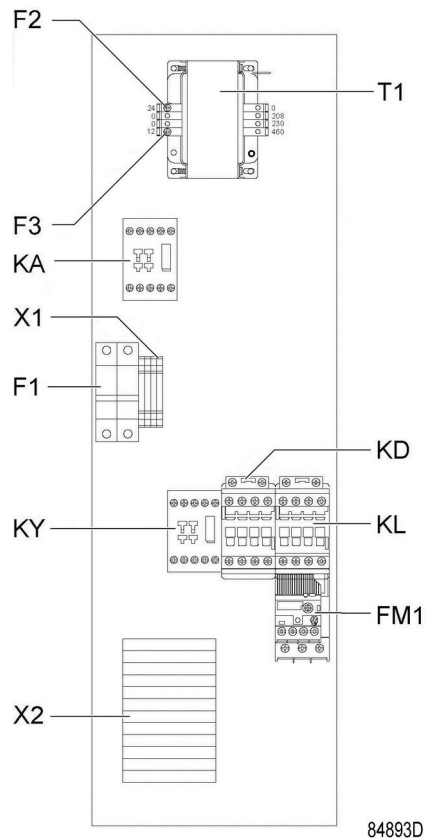

84893D

208/230/460V 60Hz

Modifications to the compressor cubicle:

| Step | Action   |
|------|--|
| 1    | Adjust the motor overload (FM1) setting.   |
| 2    | Control transformer (T1) – Move the primary connection from 230V to the desired voltage.                                 |
| 3    | Replace the control fuses (F1) 10.3 x 38mm with the ones provided (see further).<br>Use 1A fuses for 460V or 2A for 208V |
| 4    | Modify the motor terminal bridge configuration in the cubicle (X2). See further for details.                             |
| 5    | Replace the voltage sticker by the appropriate voltage sticker provided.   |

**Motor overload relay (FM1) setting:**

Rotate the adjustment screw (1) on the front of the relay to the required value.

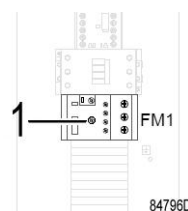

*Adjustment screw of the motor overload*

| Motor overload (FM1) settings    | 7.5 kW | 11 kW | 15 kW |
|----------------------------------|--------|-------|-------|
|                                  | 10 hp  | 15 hp | 20 hp |
| 208 V                            | 36.3   | 48    | 33.2  |
| 230 V (Standard factory setting) | 34.3   | 45    | 30    |
| 460 V                            | 16.9   | 22.5  | 15    |

**Control transformer (T1):**

Move the wire to the terminal marked with the desired voltage (208 V, 230 V or 460 V).

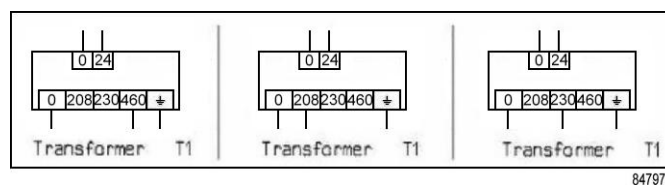

*Transformer T1*

**Fuses F1 – F3:**

The fuses are supplied with the compressor.

| Fuses | fuse rating (V) | 208 V | 230 V | 460 V | Class                              |
|-------|-----------------|-------|-------|-------|------------------------------------|
| F1    | 600 V AC        | 2 A   | 2 A   | 1 A   | UL class JDYX or JDYX2 10.3 x 38mm |

**Motor terminal bridge configuration:**

Factory standard connection is 230 V and can be changed to 208 V or 460 V.

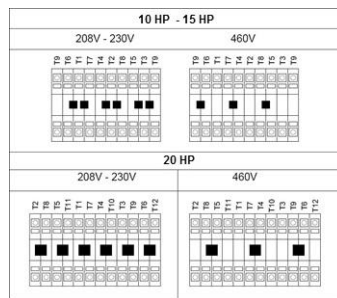

84952D

Terminal bridges (1) can be removed using a pair of pliers.

Additional terminal bridges are provided with the compressor.

**Voltage stickers:**

Locate the yellow voltage labels provided with the compressor.

Replace the existing label with the appropriate voltage label (208 V, 230 V or 460 V).

### 4.4 Pictographs

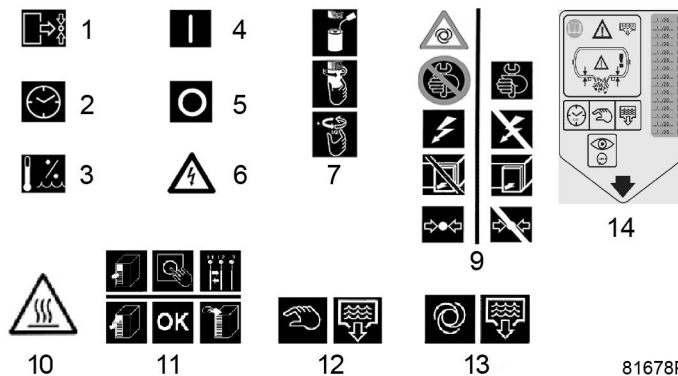

81678P

| Ref. | Description   |
|------|---|
| 1    | Working pressure  |
| 2    | Hour meter  |
| 3    | Dew point temperature   |
| 4    | Start   |
| 5    | Stop  |
| 6    | Warning: voltage  |
| 7    | Lightly oil gasket of oil filter, screw filter on and tighten by hand   |
| 9    | Warning: switch off voltage and depressurise compressor before carrying out maintenance work  |
| 10   | Warning: hot parts  |
| 11   | With all bodywork panels in place, push the start button. <ul style="list-style-type: none"> <li>• If the sheet is pulled downwards:                             <ul style="list-style-type: none"> <li>• Stop the compressor immediately and switch off the voltage.</li> <li>• Reverse two incoming electric lines and repeat the previous step.</li> </ul> </li> <li>• If the sheet is blown away, the motor rotation direction is correct.</li> </ul> |

| <b>Ref.</b> | <b>Description</b>  |
|-------------|---|
| 12          | Manual condensate drain   |
| 13          | Automatic condensate drain  |
| 14          | Drain the condensate daily and inspect the vessel yearly. Note down the inspection dates. |

## 5 Operating instructions

### 5.1 Initial start-up

#### Safety



The operator must apply all relevant [Safety precautions](#).

#### General preparation

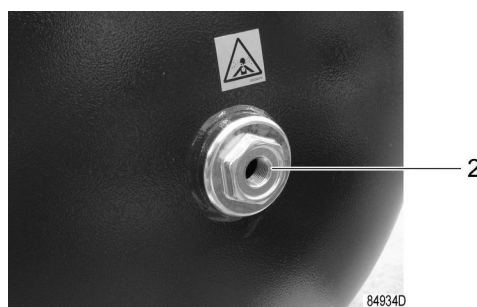

*Air receiver port*

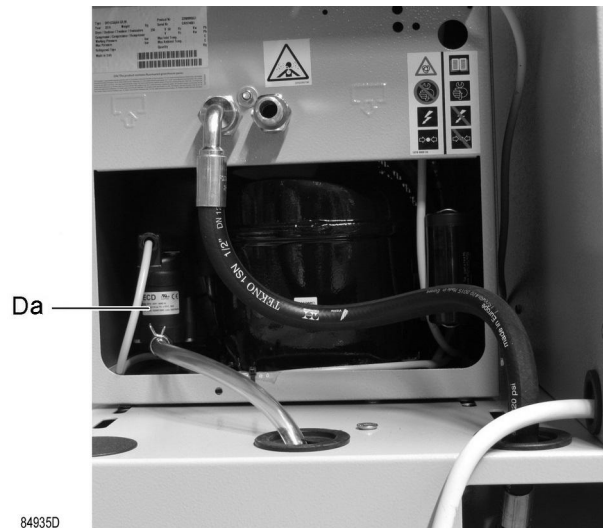

*Condensate drain*

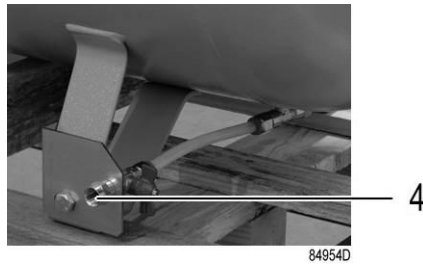

Condensate drain valve on air receiver

| Step | Action  |
|------|---|
| 1    | Consult the installation instructions (see <a href="#">Installation</a> ).  |
| 2    | Check that the electrical connections correspond to the local codes. The installation must be earthed and protected against short circuits by fuses in all phases. An isolating switch must be installed near the compressor.   |
| 3    | Connect condensate drain valve (Dm) and automatic drain outlet (Da) to a drain collector. Close the valve.<br>Connect condensate drain valve (4) of the air receiver to a drain collector. Close the valve.<br>To drain the condensate, a NPT3/8 connection is available.<br>Connect a NPT3/4 valve to the air receiver port (2). |

### Oil system

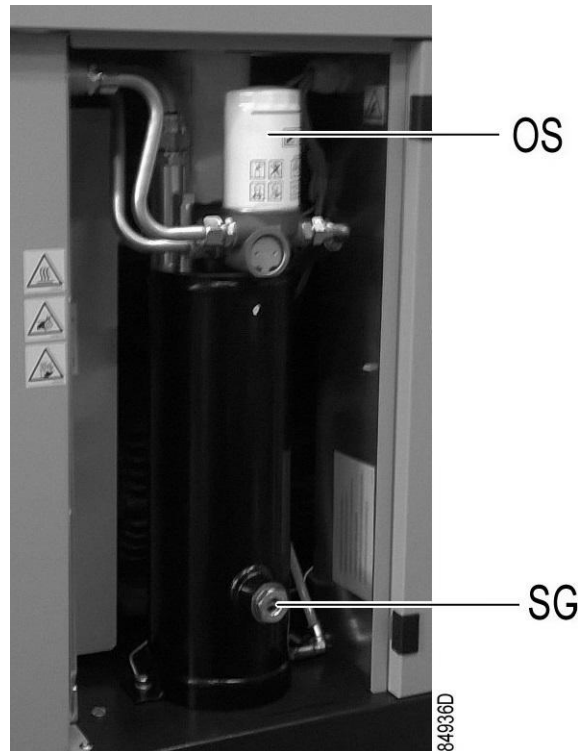

Oil level sight-glass



| Step | Action   |
|------|--|
| 1    | Check the oil level.<br>The oil level sight-glass (SG) should be between 1/4 and 3/4 full. |

**Start-up**



|                       |                        |           |
|-----------------------|------------------------|-----------|
| PRESS 3 SECONDS       | → WAIT FOR 1 SECOND    | → PRESS   |
| PREMERE 3 SECONDI     | → ASPETTARE 1 SECONDO  | → PREMERE |
| APPUYER 3 SECONDES    | → ATTENDRE 1 SECONDE   | → APPUYER |
| KNOPF DRÜCKEN (3 SEK) | → EINE SEKUNDEN WARTEN | → DRÜCKEN |
| PRESIONAR 3 SEG       | → ESPERE 1 SEGUNDO     | → PULSE   |

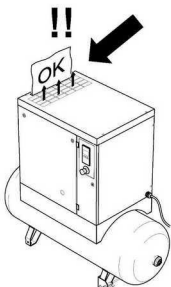

**OK**

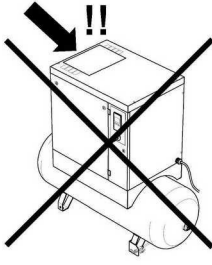

PHASES INCORRECT  
FASI INVERTITE  
PHASES INVERSÉES  
VERKEHRTE DREHRICHTUNG / PHASE  
FASES INVERTIDAS  
VERKEERDE DRAAIRICHTING

2019.1020.00.01.01  
84937D

Start-up sheet

| Step | Action   |
|------|--|
| 1    | Affix sheet (5) explaining the procedure for checking the motor rotation direction to the cooling air outlet of the compressor (consult <a href="#">Dimension drawings</a> ).<br>Switch on the voltage. Start the compressor and stop it immediately.<br>Check the rotation direction of the motor using sheet (5). If the motor rotation direction is correct, the sheet on the top grating will be blown upwards. If the sheet remains in place, the rotation direction is incorrect (see the pictographs on the label).<br>If the rotation direction is incorrect, switch off the voltage, open the isolating switch and reverse two incoming electric lines. |
| 2    | Start and run the compressor for a few minutes. Check that the compressor operates normally.   |

## 5.2 Starting

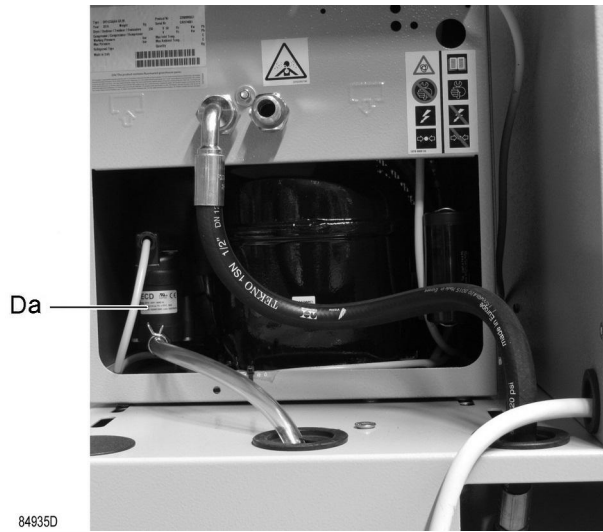

*Automatic drain*

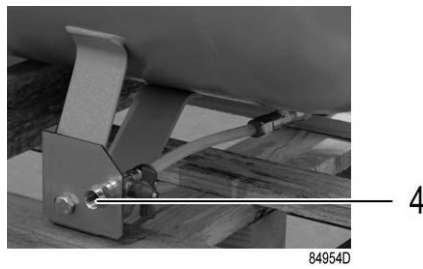

*Condensate drain valve on air receiver*

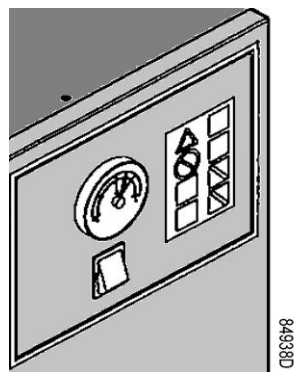

*Dew point temperature gauge*

### Starting the compressor

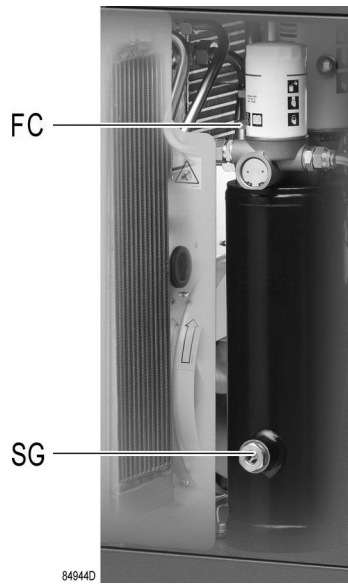

*Position of oil sight glass and filler plug*

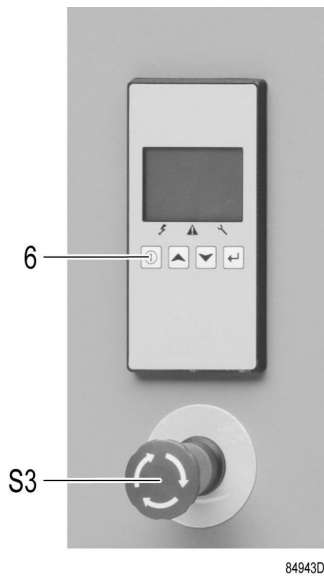

*Control panel*

| Step | Action   |
|------|--|
| 1    | Before starting, the oil level sight glass (SG) should be between 1/4 and 3/4 full.  |
| 2    | Switch on the voltage.   |
| 3    | Open air outlet valve.   |
| 4    | Push the start button (6). The motor starts running after 25 seconds.<br>On compressors with a star-delta starter, the drive motor switches over from star to delta 10 seconds after starting. |
|      | The maximum number of motor starts must be limited to 20 per hour.<br>It is strongly recommended to operate the compressor with a load factor of more than 10% to avoid condensate in the oil. |

| Step | Action   |
|------|--|
| 5    | Regularly check the oil level. 10 to 15 minutes after stopping, the sight glass (SG) should be between 1/4 and 3/4 full.<br>If the oil level is too low, stop the compressor, depressurise the oil system by unscrewing oil filler plug (FC) one turn and wait a few minutes. Remove the plug and top up the oil, until the sight glass is 3/4 full. Do not overfill. Fit and tighten plug (FC). |
| 6    | In automatic operation, the regulator is automatically controlling the compressor, i.e. loading, unloading, stopping of the motors and restarting.   |
| 7    | Regularly check the working pressure and the dew point (Units with dryer).   |
| 8    | Regularly check that condensate is drained (Da) during operation.  |

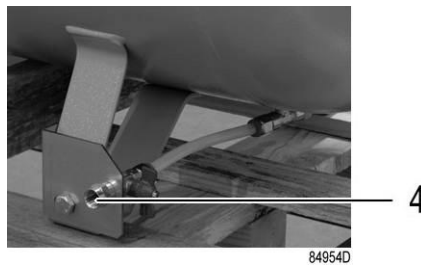

### 5.3 Stopping

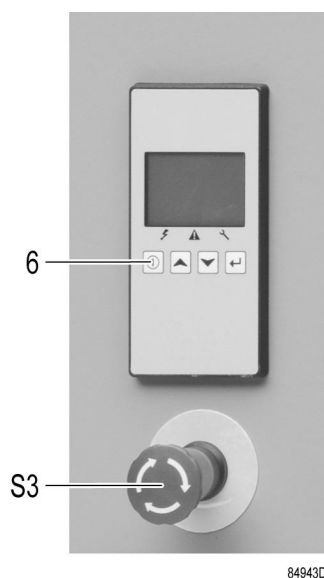

Condensate drain valve on air receiver



Control panel

| Step  | Action   |
|---|--|
| 1   | <p>Push the start/stop button (6) on the controller. The compressor will unload. When the unload time is elapsed, the compressor is stopped and the controller goes back to the main screen.</p> <p>To stop the compressor immediately in the event of an emergency, press button (S3). See section <a href="#">Control panel</a>. After remedying the fault, unlock the button by pulling it out.</p> |
|  | <p>Only use emergency stop button in the event of an emergency. Avoid using the button for normal stopping of the compressor.</p>  |
| 2   | <p>Close air outlet valve and switch off the voltage to the compressor.</p>  |
| 3   | <p>Open condensate drain valve (4) of the air receiver for a few seconds to drain any condensate and then close the valve.</p>   |
|  | <p>The air dryer and the air receiver remain under pressure. The integrated filter (if installed) remains pressurised. If maintenance or repair work is necessary, consult the <a href="#">Problem solving</a> section for all relevant safety precautions.</p>  |

## 5.4 Taking out of operation

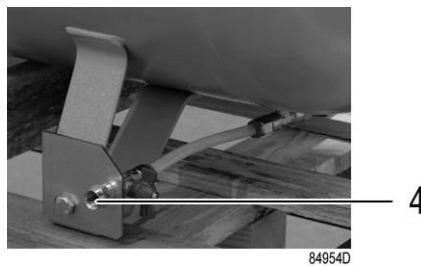

*Condensate drain valve on air receiver*

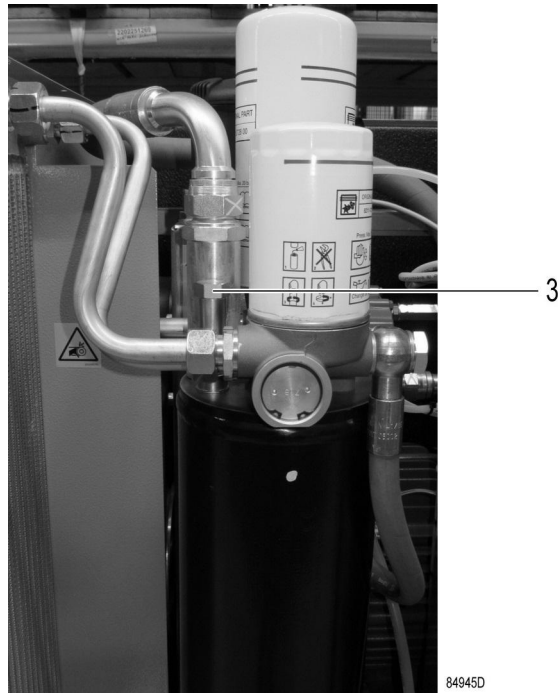

*Oil filler plug*

This procedure should be carried out at the end of the compressor's service life.

| Step | Action   |
|------|--|
| 1    | Stop the compressor and close the air outlet valve .   |
| 2    | Switch off the voltage and disconnect the compressor from the mains.   |
| 3    | Depressurise the compressor by opening plug (3) one turn.<br>Open condensate drain valve (4) of the air receiver.                        |
| 4    | Shut off and depressurise the part of the air net which is connected to the outlet valve.<br>Disconnect the compressor from the air net. |
| 5    | Drain the oil and condensate circuits.   |
| 6    | Disconnect the compressor condensate outlet and valve from the condensate net.   |

## 6 Maintenance

### 6.1 Preventive maintenance schedule

#### Warning

|   |   |
|---|---|
|  | <p><b>Before carrying out any maintenance, repair work or adjustments, proceed as follows:</b></p> <ul style="list-style-type: none"> <li>• Stop the compressor.</li> <li>• Switch off the voltage and open the isolating switch.</li> <li>• Close the air outlet valve and open the manual condensate drain valves.</li> <li>• Depressurise the compressor.</li> </ul> <p>For detailed instructions, see the next sections.<br/>The operator must apply all relevant <a href="#">Safety precautions</a>.</p> |
|---|---|

#### Warranty-Product Liability

Use only authorised parts. Any damage or malfunction caused by the use of unauthorised parts is not covered by Warranty or Product Liability.

#### General

When servicing, replace all removed gaskets, O-rings and washers.

#### Intervals

Carry out maintenance at the interval which comes first. The local Customer Centre may overrule the maintenance schedule, especially the service intervals, depending on the environmental and working conditions of the compressor.

The "longer interval" checks must also include the "shorter interval" checks.

#### Preventive maintenance schedule

| Period (1) | Running hours (1) | Operation   |
|------------|-------------------|---|
| Daily      | --                | Check the oil level.<br>After stopping, drain the condensate from the air receiver by means of the manual drain valve (4), see section <a href="#">Stopping</a> . |
| 3-monthly  | 500 (2)           | Inspect the air filter. Clean if necessary.   |
| "          | 2000              | Check the tension and the condition of the belts. Adjust if necessary.  |
| "          | 1000 (2)          | Inspect the oil cooler. Clean if necessary.   |
| "          | "                 | For versions with dryer: inspect the condenser of the dryer. Clean if necessary.  |
| Yearly     | 2000              | Replace the oil filter.   |
| "          | "                 | Replace the oil.  |
| "          | "                 | Replace the air filter.   |
| "          | 4000 (2)          | Replace the oil separator element.  |
| "          | 4000              | Replace the belts.  |

| Period (1) | Running hours (1) | Operation   |
|------------|-------------------|---|
| “          | “                 | Install the drain wear kit.   |
| “          | “                 | Have the safety valve tested.   |
| “          | “                 | Have the operation of sensors, electrical interlockings and components checked.   |
| “          | “                 | Have the temperature shutdown switch tested.  |
| “          | “                 | Inspect the air receiver.<br>The air receiver must no longer be used and must be replaced if the wall thickness is less than the minimum value, specified in the technical documentation of the air receiver. |
| “          | 8000 (3)          | If Roto Extend oil is used, change the oil.   |
| “          | 8000              | Replace the thermostatic valve and overhaul the minimum pressure valve.   |
| “          | “                 | Check and clean the inlet valve. Use the unloader kit.  |
| “          | “                 | Replace the electronic drain.   |

(1): whichever comes first.

(2): more frequently in a dusty environment

(3): The indicated oil exchange intervals are valid for standard operating conditions (see section [Reference conditions and limitations](#)) and nominal operating pressure (see section [Compressor data](#)). Exposure of the compressor to external pollutants or operation at high humidity combined with low duty cycles may require a shorter oil exchange interval. Contact your supplier if in doubt.

### Important



- Always consult your supplier if a service timer setting has to be changed.
- For the change interval of oil and oil filter in extreme conditions, consult your Customer Centre.
- Any leakage should be attended to immediately. Damaged hoses or flexible joints must be replaced.

## 6.2 Drive motor

### General

Keep the outside of the electric motor clean for efficient cooling. If necessary, remove dust with a brush and/or compressed air jet.

### Description

The motor bearings are greased for life.



## 6.3 Oil specifications



Never mix oils of different brands or types as they may not be compatible and the oil mix will have inferior properties. A label, indicating the type of oil filled ex-factory, is stuck on the air receiver/oil tank.

It is strongly advised to use the recommended lubricants. See section Preventive maintenance schedule for recommended oil change intervals.

For part numbers, consult the Spare Parts List.

### Rotair

Rotair is a specially developed lubricant for use in single stage oil-injected screw compressors. Its specific composition keeps the compressor in excellent condition. Rotair can be used for compressors operating at ambient temperatures between 0 °C (32 °F) and 40 °C (104 °F). If the compressor is regularly operating in ambient temperatures between 40 °C and 46 °C (115 °F), oil lifetime is reduced significantly.

## 6.4 Oil, filter and separator change

### Important



Never mix oils of different brands or types. A label, indicating the type of oil filled ex-factory, is stuck on the air receiver/oil tank.  
 Always drain the compressor oil at all drain points. Used oil left in the compressor can shorten the lifetime of the new oil.  
 If the compressor is exposed to external pollutants, is being used at high temperatures (oil temperature above 90°C / 194°F) or is being used under severe conditions, it is advised to change the oil more frequently. Consult your supplier.

### Location of oil filter and separator

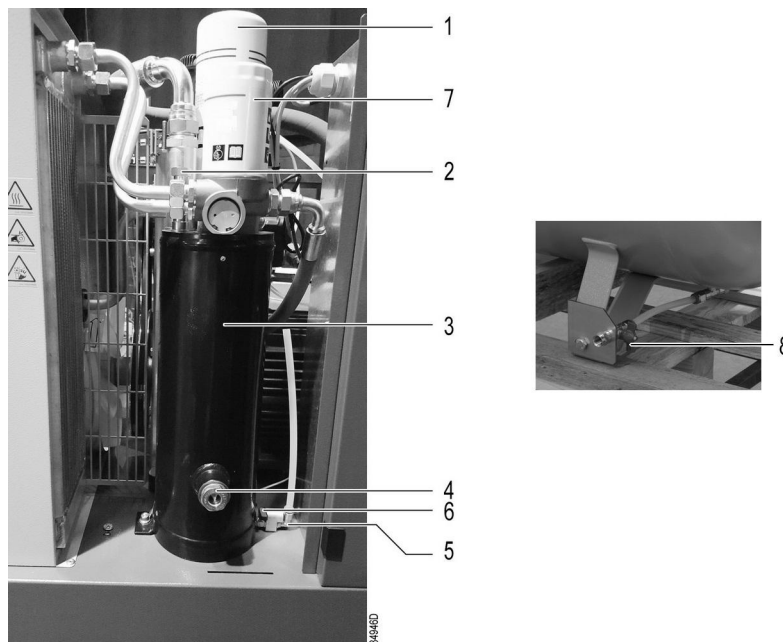

| Step | Action  |
|------|---|
| 1    | Run the compressor until warm. Stop the compressor, close the air outlet valve and switch off the voltage. See <a href="#">Stopping</a> .   |
| 2    | Depressurise the air receiver by opening drain valve (8).   |
| 3    | Depressurise the compressor by unscrewing filler plug (2) one turn to permit any pressure in the system to escape. Remove the plug after the system is depressurised.                                 |
| 4    | Remove plug (5), drain the oil by opening drain valve (6). Close the valve and refit the plug after draining. Deliver the drained oil to the local oil collection service.                            |
| 5    | Remove oil filter (7) and, if it needs to be replaced, remove the oil separator (1). Clean the seats on the manifold.   |
| 6    | Oil the gaskets of the new filter and separator and screw them into place. Tighten firmly by hand.  |
| 7    | Fill oil separator/tank (3) with oil until the level reaches the middle of sight-glass (4). Ensure no dirt gets into the system.  |
| 8    | Refit and tighten filler plug (2).  |
| 9    | Close drain valve (8) of the air receiver.  |
| 10   | Run the compressor for a few minutes.   |
| 11   | Stop the compressor and wait a few minutes to allow the oil to settle.  |
| 12   | If the oil level is too low, depressurise the system by unscrewing filler plug (2) one turn to permit any pressure in the system to escape. Depressurise the air receiver by opening drain valve (8). |
| 13   | Add oil as necessary. The sight-glass should be 3/4 full. Retighten plug (2) and close drain valve (8) of the air receiver.   |

---

## 6.5 Storage after installation

If the compressor is stored without running from time to time, consult your supplier as protective measures may be necessary.

## 6.6 Service kits

### Service kits

For overhauling and for preventive maintenance, a wide range of service kits is available. Service kits comprise all parts required for servicing the component and offer the benefits of genuine parts while keeping the maintenance budget low.

Also a full range of extensively tested lubricants, suitable for your specific needs is available to keep the compressor in excellent condition.

Consult the Spare Parts List for part numbers.

## 6.7 Disposal of used material

Used filters or any other used material (e.g. desiccant, lubricants, cleaning rags, machine parts, etc.) must be disposed of in an environmentally friendly and safe manner, and in line with the local recommendations and environmental legislation.

Electronic components are subject to the EU Directive 2012/19/EC for Waste Electrical and Electronic Equipment (WEEE). As such, these parts must not be disposed of at a municipal waste collection point. Refer to local regulations for directions on how to dispose of this product in an environmental friendly manner.

## 7 Adjustments and servicing procedures

### 7.1 Air filter

#### Changing the air filter



*Air filter*

Procedure:

| Step | Action   |
|------|--|
| 1    | Stop the compressor, close the air outlet valve and switch off the voltage.                  |
| 2    | Remove the front panel and the top panel of the compressor housing.                          |
| 3    | Unscrew the filter cover (AF) and remove the filter element. Discard the air filter element. |
| 4    | Fit the new element and screw on the filter cover.   |
| 5    | Refit the top and front panels.  |

## 7.2 Coolers

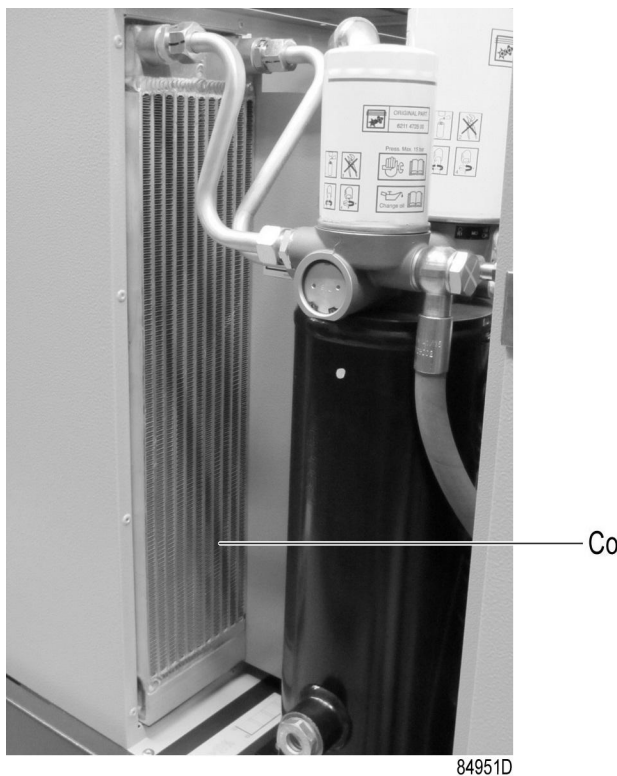

| Step | Action   |
|------|--|
| 1    | Keep oil cooler (Co) clean to maintain the cooling efficiency.   |
| 2    | Stop the compressor, close the air outlet valve and switch off the voltage. Remove any dirt from the oil cooler (Co) with a fibre brush. |

## 7.3 Safety valve

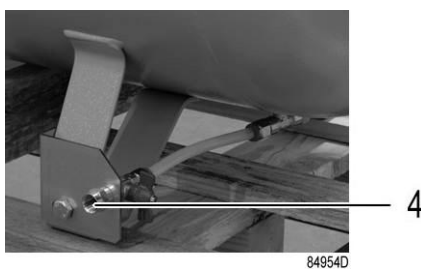

*Condensate drain valve*

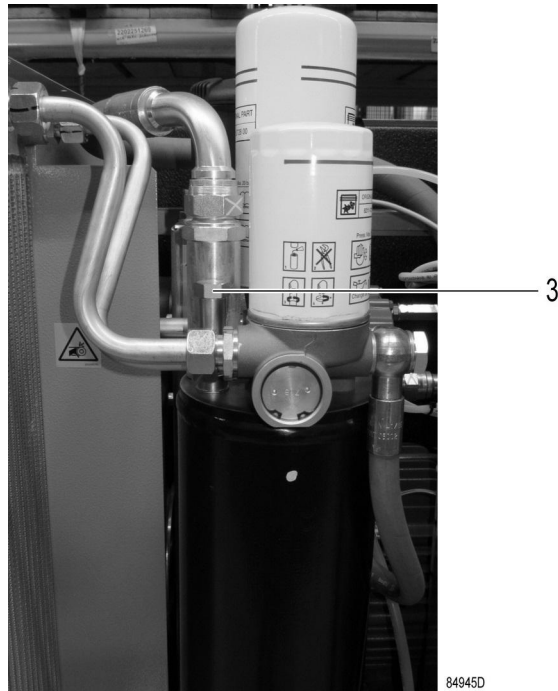

*Oil filler plug*

## Testing

The valve can be tested on a separate compressed air line.

Before removing the safety valve, stop the compressor (see section [Stopping](#)), close the air outlet valve, switch off the voltage, open drain valves (4) (tank-mounted units) and the manual drain valve (5) (if fitted - on floor-mounted units) and unscrew filler plug (3) one turn to permit any pressure in the system to escape.



If the valve does not open at the set pressure stamped on the valve, replace the valve. No adjustments are allowed. Never run the compressor without a safety valve.

## 7.4 Belt set exchange and tensioning

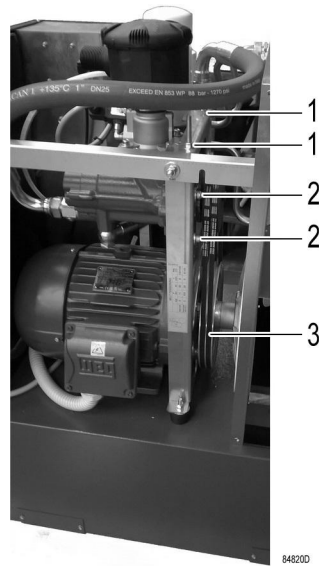

Read the warning in the [Preventive maintenance schedule](#) section.

### Checking the belt tension

| Step | Action  |
|------|---|
| 1    | Stop the compressor, close the air outlet valve and switch off the voltage  |
| 2    | Remove the front door and the internal panel.   |
| 3    | <p>The force and deflection varies with the power of the unit, and with the total running hours of the belt.</p> <p>The values to be measured are indicated with a label (1) on the frame:</p> <div data-bbox="758 1346 1177 1861" data-label="Image"> </div> |
| 4    | Refit the bodywork panels.  |



Tensioning of the belts must be performed with specific dedicated tooling.

### Adjusting the tension of the drive belts

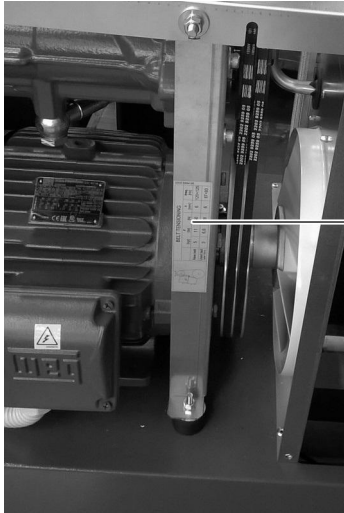
| Step | Action  |
|------|---|
| 1    | Stop the compressor, close the air outlet valve and switch off the voltage.   |
| 2    | Remove the front door, the internal panel, the top cover and the pulley protection.   |
| 3    | Loosen the 4 bolts (2) by one turn.   |
| 4    | Adjust the belt tension by turning tensioning nut (1).  |
| 5    | <p>The force and deflection varies with the power of the unit, and with the total running hours of the belt.</p> <p>The values to be measured are indicated with a label (1) on the frame:</p>  <p style="text-align: right; margin-right: 10px;">1</p> <p style="text-align: right; font-size: small;">84821D</p> |
| 6    | Retighten bolts (2).  |
| 7    | Refit the bodywork panels.  |



## Replacing the drive belts

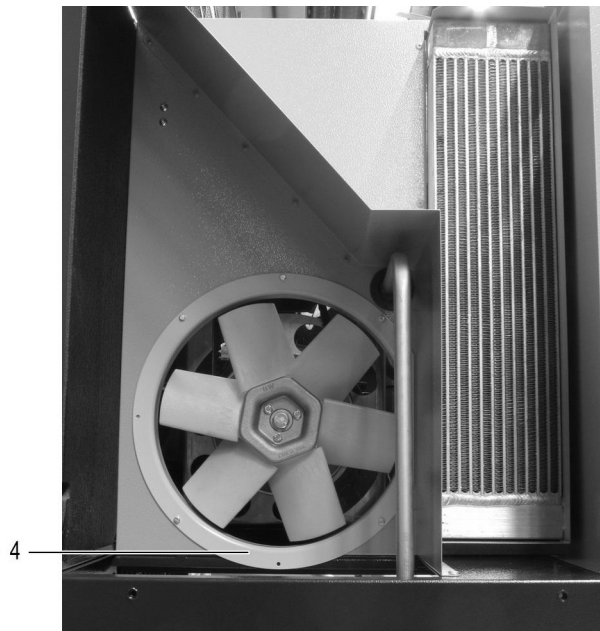

84949D

| Step  | Action   |
|---|--|
|  | The belts (3) must be replaced as a set, even if only one of the belts is worn. Only use genuine belts.  |
| 1   | Stop the compressor, close the air outlet valve and switch off the voltage.                              |
| 2   | Remove the front door, the internal panel, the top cover, the pulley protection and the left side panel. |
| 3   | Loosen the 4 bolts (2) by one turn.  |
| 4   | Release the belt tension by loosening tensioning nut (1).  |
| 5   | Remove the fan duct (4).<br>Remove the belts.  |
| 6   | Install the new belts.   |
| 7   | Tension belts (3) as described above.  |
| 8   | Reassemble the fan duct (4), the pulley protection and the internal protection panel.                    |
| 9   | Reassemble left side and top panel cover.  |
| 10  | Check the belt tension after 50 running hours.   |

## 8 Problem solving

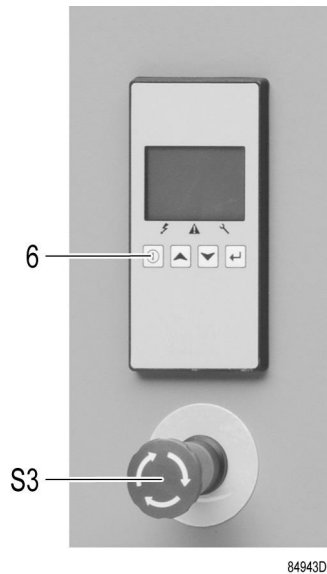

*Control panel*

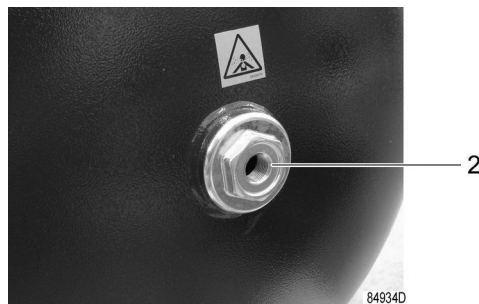

*Air outlet valve*

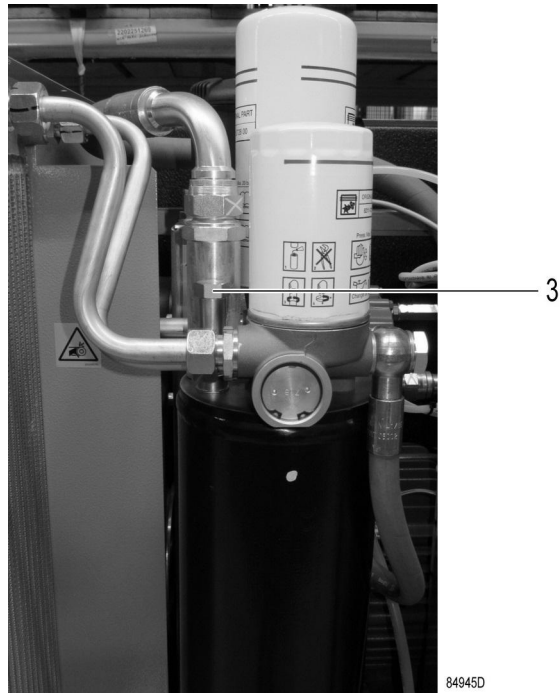

*Oil filler plug*

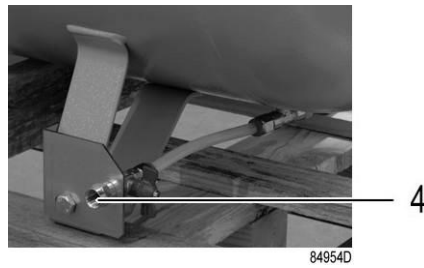

*Condensate drain valve on air receiver*

### Attention

|   |  |
|---|--|
|  | <p>Use only authorised parts. Any damage or malfunction caused by the use of unauthorised parts is not covered by Warranty or Product Liability.<br/>Apply all relevant <a href="#">Safety precautions during maintenance or repair</a>.</p>   |
|   | <p>Before carrying out any maintenance or repair work on the compressor: push the stop button (6).<br/>Wait until the compressor has stopped and switch off the voltage. See the <a href="#">Stopping</a> section.<br/>Open the isolating switch to prevent an accidental start.<br/>Close air outlet valve (2) and depressurise the compressor by opening the oil filler plug (3) one turn.<br/>Open manual condensate drain valves (4 and/or 5).</p> |
|   | <p><b>The air outlet valve (2) can be locked during maintenance or repair as follows:</b></p> <ul style="list-style-type: none"> <li>• Close the valve.</li> <li>• Remove the screw fixing the handle.</li> <li>• Remove the handle.</li> <li>• Fit the screw.</li> </ul>  |

### Faults and remedies

For all references given hereafter, see [Air flow diagram](#), [Initial start-up](#) or [Regulating system](#).

|   | Condition   | Fault   | Remedy   |
|---|---|---|--|
| 1 | Compressor starts running, but does not load after a delay time | Solenoid valve (Y1) out of order                                | Replace valve  |
|   |   | Inlet valve (IV) stuck in closed position                       | Have valve checked   |
|   |   | Leak in control air flexibles                                   | Replace leaking flexible   |
|   |   | Minimum pressure valve (Vp) leaking (when net is depressurised) | Have valve checked   |
| 2 | Compressor air output or pressure below normal                  | Air consumption exceeds air output of compressor                | Check equipment connected  |
|   |   | Choked air inlet filter element (AF)                            | Replace filter element   |
|   |   | Solenoid valve (Y1) malfunctioning                              | Replace valve  |
|   |   | Leak in control air flexibles                                   | Replace leaking flexible   |
|   |   | Inlet valve (IV) does not fully open                            | Have valve checked   |
|   |   | Oil separator (OS) clogged                                      | Replace separator element  |
|   |   | Safety valves leaking   | Replace valves   |
| 3 | Air outlet temperature above normal                             | Insufficient cooling air or cooling air temperature too high    | Check for cooling air restriction or improve ventilation of compressor room. Avoid recirculation of cooling air. If installed, check capacity of compressor room fan |
|   |   | Oil level too low   | Check and correct as necessary   |

|  | <b>Condition</b> | <b>Fault</b>                        | <b>Remedy</b>         |
|--|------------------|-------------------------------------|-----------------------|
|  |                  | Cooler clogged                      | Clean cooler          |
|  |                  | Compressor element (E) out of order | Consult your supplier |

## 9 Technical data

### 9.1 Electric cable size

#### Attention



The voltage on the compressor terminals must not deviate more than 10% from the nominal voltage.  
 It is however highly recommended to keep the voltage drop over the supply cables at nominal current below 5% of the nominal voltage.  
 If cables are grouped together with other power cables, it may be necessary to use cables of a larger size than those calculated for the standard operating conditions.  
 Use the original cable entry. See section [Dimension drawings](#).  
 The compressor is delivered with 3 m (10 ft.) cable and a fitting cable gland.  
 This cable gland is necessary to ensure the protection degree of the electric cubicle and to protect its components from dust from the environment.  
 Local regulations remain applicable if they are stricter than the values proposed below.

| Power variant  |             | 7.5 kW<br>10 hp | 11 kW<br>15 hp | 15kW<br>20 hp |
|----------------|-------------|-----------------|----------------|---------------|
| Frequency (Hz) | Voltage (V) | Cable Size      | Cable Size     | Cable Size    |
| UL/cUL         |             |                 |                |               |
| 60             | 208–230–460 | AWG8/AWG10      | AWG6/AWG10     | AWG4/AWG8     |
| 60             | 575         | AWG12           | AWG10          | AWG10         |

### 9.2 Settings for overload relay and fuses

|                |                       | 7.5 kW<br>10hp                 |   | 11 kW<br>15hp                  |   | 15 kW<br>20hp                  |   |
|----------------|-----------------------|--------------------------------|---|--------------------------------|---|--------------------------------|---|
| Frequency (Hz) | Voltage (V)<br>UL/cUL | Setting overload relay FM1 (A) | Main fuses (class J or RK) + Disc. switch size $\geq 1.25 \times$ FLA | Setting overload relay FM1 (A) | Main fuses (class J or RK) + Disc. switch size $\geq 1.25 \times$ FLA | Setting overload relay FM1 (A) | Main fuses (class J or RK) + Disc. switch size $\geq 1.25 \times$ FLA |
| 60             | DOL<br>208-230–460    | 36.3-34.3–16.9                 | 50-45–25 A  | 48-45–22.5                     | 60-60–35 A  | N/A                            | N/A   |
| 60             | YD<br>208-230–460     | N/A                            | N/A   | N/A                            | N/A   | 33.2-30–15                     | 80-80–40 A  |
| 60             | DOL<br>575            | 13                             | 20 A  | 18.5                           | 25 A  | N/A                            | N/A   |
| 60             | YD<br>575             | N/A                            | N/A   | N/A                            | N/A   | 12                             | 30 A  |

## 9.3 Reference conditions and limitations

### Reference conditions

|                               |        |                                     |
|-------------------------------|--------|-------------------------------------|
| Air inlet pressure (absolute) | bar    | 1                                   |
| Air inlet pressure (absolute) | psi    | 14.5                                |
| Air inlet temperature         | °C     | 20                                  |
| Air inlet temperature         | °F     | 68                                  |
| Relative humidity             | %      | 0                                   |
| Working pressure              | bar(e) | See <a href="#">Compressor data</a> |
| Working pressure              | psi    | See <a href="#">Compressor data</a> |

### Limitations

|                             |        |                                     |
|-----------------------------|--------|-------------------------------------|
| Maximum working pressure    | bar(e) | See <a href="#">Compressor data</a> |
| Maximum working pressure    | psig   | See <a href="#">Compressor data</a> |
| Minimum working pressure    | bar(e) | 4                                   |
| Minimum working pressure    | psig   | 58                                  |
| Minimum ambient temperature | °C     | 0                                   |
| Minimum ambient temperature | °F     | 32                                  |

## 9.4 Compressor data

|                                       |   |     |     |      |      |
|---------------------------------------|---|-----|-----|------|------|
| <b>Compressor type</b>                | <b>7.5kW / 10HP<br/>11kW / 15HP<br/>15kW / 20HP</b> |     |     |      |      |
| Frequency                             | Hz  | 60  | 60  | 60   | 60   |
| Maximum (unloading) pressure UL units | bar   | 7.4 | 9.1 | 10.8 | 12.5 |
| Maximum (unloading) pressure UL units | psig  | 107 | 132 | 157  | 182  |
| Nominal working pressure              | bar   | 6.9 | 8.6 | 10.3 | 12.1 |
| Nominal working pressure              | psig  | 100 | 125 | 150  | 175  |
| Set-point, thermostatic valve         | °C  | 71  | 71  | 71   | 71   |
| Set-point, thermostatic valve         | °F  | 160 | 160 | 160  | 160  |

### 7.5kW / 10HP

|  |    |                     |
|--|----|---------------------|
|  |    | <b>7.5kW / 10HP</b> |
| Temperature of air leaving outlet valve (ambient +) approx., tank mounted units. | °C | 7                   |
|  | °F | 45                  |

|  |        |       |       |
|--|--------|-------|-------|
| Temperature of air leaving outlet valve (ambient +)<br>approx., floor mounted units. | °C     | 25    |       |
|  | °F     | 77    |       |
| Temperature of air leaving outlet valve (ambient +)<br>approx., units with dryer.    | °C     | 4     |       |
|  | °F     | 39    |       |
| Frequency  | Hz     | 50    | 60    |
| Nominal motor power rating.  | kW     | 7.5   |       |
|  | hp     | 10    |       |
| Dryer power consumption at full load, units with dryer.                              | kW     | 0.475 | 0.474 |
|  | hp     | 1.32  | 1.32  |
| Oil capacity   | l      | 3.2   |       |
|  | US gal | 0.84  |       |
| Sound pressure level (ISO 2151 - 2004)   | db(A)  | 66    |       |

**11kW / 15HP**

|  |        | <b>11kW / 15HP</b> |       |
|--|--------|--------------------|-------|
| Temperature of air leaving outlet valve (ambient +)<br>approx., tank mounted units.  | °C     | 9                  |       |
|  | °F     | 48                 |       |
| Temperature of air leaving outlet valve (ambient +)<br>approx., floor mounted units. | °C     | 28                 |       |
|  | °F     | 82                 |       |
| Temperature of air leaving outlet valve (ambient +)<br>approx., units with dryer.    | °C     | 5                  |       |
|  | °F     | 41                 |       |
| Frequency  | Hz     | 50                 | 60    |
| Nominal motor power rating.  | kW     | 11                 |       |
|  | hp     | 15                 |       |
| Dryer power consumption at full load, units with dryer.                              | kW     | 0.385              | 0.581 |
|  | hp     | 1.07               | 1.61  |
| Oil capacity   | l      | 3.2                |       |
|  | US gal | 0.84               |       |
| Sound pressure level (ISO 2151 - 2004)   | db(A)  | 68                 |       |

**15kW / 20HP**

|  |    | <b>15kW / 20HP</b> |    |
|--|----|--------------------|----|
| Temperature of air leaving outlet valve (ambient +)<br>approx., tank mounted units.  | °C | 11                 |    |
|  | °F | 52                 |    |
| Temperature of air leaving outlet valve (ambient +)<br>approx., floor mounted units. | °C | 30                 |    |
|  | °F | 86                 |    |
| Temperature of air leaving outlet valve (ambient +)<br>approx., units with dryer.    | °C | 6                  |    |
|  | °F | 43                 |    |
| Frequency  | Hz | 50                 | 60 |
| Nominal motor power rating.  | kW | 15                 |    |
|  | hp | 20                 |    |



|   |        |       |       |
|---|--------|-------|-------|
| Dryer power consumption at full load, units with dryer. | kW     | 0.385 | 0.581 |
|   | hp     | 1.07  | 1.61  |
| Oil capacity  | l      | 3.2   |       |
|   | US gal | 0.84  |       |
| Sound pressure level (ISO 2151 - 2004)                  | db(A)  | 71    |       |

## 10 Instructions for use

### Oil separator vessel

|   |  |
|---|--|
| 1 | The vessel can contain pressurised air. This can be potentially dangerous if the equipment is misused.   |
| 2 | This vessel must only be used as a compressed air/oil separator tank and must be operated within the limits specified on the data plate.   |
| 3 | No alterations must be made to this vessel by welding, drilling or other mechanical methods without the written permission of the manufacturer.  |
| 4 | The pressure and temperature of this vessel must be clearly indicated.   |
| 5 | The safety valve must correspond with pressure surges of 1.1 times the maximum allowable operating pressure. It should guarantee that the pressure will not permanently exceed the maximum allowable operating pressure of the vessel. |
| 6 | Use only oil as specified by the manufacturer.   |

### Air receiver (on tank-mounted units)

|   |   |
|---|---|
| 1 | <b>Corrosion must be prevented: depending on the conditions of use, condensate may accumulate inside the tank and must be drained every day.</b> This may be done manually by opening the drain valve, or by means of the automatic drain, if fitted to the tank. Nevertheless, a weekly check of correct functioning of the automatic valve is needed. This has to be done by opening the manual drain valve and check for condensate. Verify that no rust obstructions affect the drain system. |
| 2 | <b>Yearly service inspection of the air receiver is needed, as internal corrosion can reduce the steel wall thickness with the consequent risk of bursting.</b> Local rules need to be respected, if applicable. The use of the air receiver is forbidden once the wall thickness reaches the minimum value as indicated in the service manual of the air receiver (part of the documentation delivered with the unit).   |
| 3 | Lifetime of the air receiver mainly depends on the working environment. Installing the compressor in a dirty and corrosive environment is not allowed, as this can reduce the vessel lifetime dramatically.   |
| 4 | Do not anchor the vessel or attached components directly to the ground or fixed structures. Fit the pressure vessel with vibration dampers to avoid possible fatigue failure caused by vibration of the vessel during use.  |
| 5 | Use the vessel within the pressure and temperature limits stated on the nameplate and the testing report.   |
| 6 | No alterations must be made to this vessel by welding, drilling or other mechanical methods.  |

## 11 Guidelines for inspection

### Guidelines

On the Declaration of Conformity / Declaration by the Manufacturer, the harmonised and/or other standards that have been used for the design are shown and/or referred to.

The Declaration of Conformity / Declaration by the Manufacturer is part of the documentation that is supplied with this compressor.

Local legal requirements and/or use outside the limits and/or conditions as specified by the manufacturer may require other inspection periods as mentioned below.





People.  
Passion.  
Performance.