

# 5-15 HP Electric Rotary Screw Compressors

## Owners Manual



**Introduction.** Congratulations on the purchase of your new air compressor. The air compressor is precision built from the finest materials using the finest state of the art design, and high tech engineering available today. Quality, performance and trouble free operation will assure you a dependable supply of air power on demand

Check [www.compressed-air-systems.com](http://www.compressed-air-systems.com) for most up to date manual and compressor service and technical information

**CAUTION** READ THIS MANUAL CAREFULLY before operating or servicing this air compressor, to familiarize yourself with the proper safety, operation, and standard operating procedures of this unit. **FAILURE TO COMPLY WITH INSTRUCTIONS IN THIS MANUAL COULD RESULT IN THE VOIDING OF YOUR WARRANTY, AND PERSONAL INJURY, AND/OR PROPERTY DAMAGE. THE MANUFACTURER OF THIS AIR COMPRESSOR WILL NOT BE LIABLE FOR ANY DAMAGE BECAUSE OF FAILURE TO FOLLOW THE INSTRUCTIONS IN THIS MANUAL.** By following the instructions and recommendations in this manual you will ensure a longer and safer service life of your air compressor.

If you have questions or need clarification about this manual or your compressor call 800-531-9656

***Do not operate compressor outdoors in wet weather***

**Industrial Gold**  
Quality Air Compressor at a Great Price.

industrialgold.com ■ 1-800-531-9656 ■ Fax 972-352-6364



**WARNING:** Read all installation steps in install guide, and compressor package manual prior to un-crating or installing compressor package. Failure to do so can result in personal injury or damage to compressor package.

**NOTICE:** All compressor air receivers should be inspected by a certified pressure vessel technician at least once per year, to check for leaks, weak points in the metal or any other deformity of the air receiver. If at any time a receiver appears out of conformance with ASME/CRN certification or a deformity is believed to have developed no matter how minor it may appear the tank should be locked out of service immediately and replaced with a certified ASME/CRN certified air receiver immediately before the compressor can be put back into service. The receivers should have a general inspection weekly as part of normal service.

### SAFETY PRECAUTIONS AND WARNINGS

Listed are some, but not all safety precautions that must be observed with compressors and compressed air systems. Failure to follow any of these warnings may result in severe personal injury, death, property damage and/or compressor damage.

**Air from this compressor will cause severe injury or death if used for breathing or food processing.**

**Air used for these processes must meet OSHA 29 CFR 1910 or FDA 21 178.3570 regulations.**

**This compressor is designed for use in the compression of normal atmospheric air only. No other gases, vapors or fumes should be exposed to the compressor intake, nor processed through the compressor.**

**Disconnect all power supplies to the compressor plus any remote controllers prior to servicing the unit.**

**Relieve all pressure internal to the compressor prior to servicing.**

**Do not depend on check valves to hold system pressure.**

**A properly sized safety valve must be installed in the discharge piping ahead (upstream) of any shut-off valve (block valve), heat exchanger, orifice or any potential blockage point. Failure to install a safety relief valve could result in rupturing or explosion of some compressor or safety component.**

**Do not change the pressure setting of the safety relief valve, restrict the function of the safety relief valve, or replace the safety valve with a plug.**

**Over pressurization of some system or compressor component can occur, resulting in severe personal injury, death and property damage.**

**Never use plastic pipe, rubber hose, or soldered joints in any part of the compressed air system.**

**Failure to ensure system compatibility with compressor piping is dangerously unsound.**

**Never use a flammable or toxic solvent for cleaning the air filter or any parts.**

**Do not attempt to service any part while the compressor is operating.**

**Do not operate the compressor at pressures in excess of its rating.**

**Do not remove any guards while the compressor is operating.**

**Observe gauges daily to ensure compressor is operating properly.**

**Follow all maintenance procedures and check all safety devices on schedule.**

**Compressed air is dangerous, do not play with it.**

**Use the correct lubricant at all times.**

**Always wear proper safety equipment when using compressed air.**

**Always install compressor to all local applicable electric codes.**

**WARNING:** Always wear proper protective eye ware, hearing protection and safety clothing when working around the compressor package. No loose or baggy clothing should be worn around compressor package at any time.

**WARNING:** On Electric motor powered air compressors make sure electrical system is up to National Electric Code (NEC) prior to installing compressor system. Failure to install a compressor with a proper NEC electrical system can cause personal injury, compressor package damage and void compressor package warranty

**NOTICE:** To ensure full compressor tank warranty all tank mounted compressor packages must be mounted on factory approved vibration isolation pads. A compressor should NEVER be installed while still on or in its original packaging. Failure to properly install the compressor system with approved vibration isolation pads will result in the compressor tank warranty being void.

**WARNING:** Compressed Air Systems compressors can operate at pressures from 0-250psi depending on the compressor package design and build specifications. Always verify that the system the compressor is installed into can handle the maximum operational pressure the compressor. NEVER install a compressor in a system that can not handle the compressors maximum operating pressure.

**WARNING:** Compressed air is extremely dangerous when not properly used or installed. Always make sure a trained compressed air professional has looked over the air system prior to use. Improper installation or use of compressed air can cause bodily injury or death. NEVER pressurize an object that was not designed to be pressurized. Pressurizing objects not properly engineered for the maximum operating pressure of the compressor system can cause bodily injury or death.

**WARNING:** Never apply air pressure to compressor crank case, always make sure crank case vent is clear and free from obstructions. Adding pressure to the crank case can cause serious bodily injury or death.

**WARNING:** Never operate a compressor in a moving vehicle or towable object in motion. Doing so can damage the compressor, compressor drive components, or auxiliary parts on the compressor package. Operating the compressor in a moving vehicle or towable object can cause serious bodily injury or death.

**WARNING:** Check function of safety valves, weekly to insure proper function, replace immediately if faulty or damaged.

**WARNING:** (Compressors Packaged with NEMA 7 Components)

Compressed Air Systems, LLC certifies that the electric motor, electrical enclosure and electrical conduit are rated for NEMA7/hazardous locations. (Only for applicable packages with NEMA7 added components)

Air compressors have multiple moving parts and potential points of contact that could create an ignition source. The compressor pumps are manufactured with ferrous metals and in some cases multiple moving parts can come in contact with one another causing an ignition source. Compressed Air Systems LLC does not guarantee this will not occur. Lack of maintenance or care can result in conditions that could also cause ignition sources.

Compressed Air Systems, LLC only guarantees that the electric motor, electrical enclosure and electrical conduit are rated for NEMA7 hazardous location. Compressed Air Systems LLC accept no other responsibility for the rating of the package.

## Descriptions

This Compressed Air Systems industrial rotary screw compressor is an electric motor driven single stage helical rotary screw compressor. It is sold as a complete package mounted on a steel base. This unit can come with options of being tank mounted, Enclosure mounted or Enclosure tank mounted. The package includes the compressor air end, electric motor, motor controls, air intake system, cooling system, SMART contact capacity control system, air/oil separator, and instrumentation. Installation requires only electric power and a service line.

This air compressor is a rotating piece of equipment and should not be worked on or serviced while there is power to the unit. You should always turn the power off to the compressor unit before performing any kind of service to the machine. If you have any questions please contact the factory for clarifications before making any changes to the delivered state of the compressor.

**The owner, lesser, or operator of this compressor is hereby notified and forewarned that any failure to observe these safety precautions in this manual may result in injury, damage to the unit or death.**

Compressed Air Systems expressly disclaims responsibility or liability for any injury or damage caused by failure to follow these specified precautions or by failure to exercise that ordinary caution and due care required in operation or handling the compressor even though not expressly specified here. If you have any questions contact the factory immediately at 1-800-531-9656

### COMPRESSOR

The compressor assembly is a positive displacement, oil flood lubricated, helical rotary screw type unit employing a single stage of compression. The components include housing or stator, two rotors or screws, bearings and bearing supports.

In operation two helical grooved rotors mesh to compress air. Inlet air entering the compressor becomes trapped between the lobes of the rotors. As the rotors turn, this trapped volume of air is reduced in volume or compressed and is pushed to the discharge end of the compressor. This process delivers smooth flowing air at full pressure to the receiver.

During the compression cycle, oil is injected into the compressor for the purposes of lubricating, cooling, and sealing. Compressed air laden with oil leaves the compressor through a discharge port designed to provide optimum performance within the desired pressure range.

### AIR/OIL SYSTEM

The air/oil system is almost completely contained within the compressor housing. Within or directly attached to the housing are the air filter, oil filter and the air/oil separator element.

### AIR FILTER

The air filter is a high efficiency ring style located on top of the inlet valve of the compressor. It will provide nearly constant efficiency of filtration at all load conditions. The element has a high dirt holding capacity for a long life.

It is specially treated to be insensitive to heat, cold, water, and oil.

### OIL FILTER

The oil filter is a 10-micron spin-on style. It is sized to maintain system cleanliness and to give good service life. The housing is equipped with a bypass to insure that there is oil flow on startup. The restriction created at the filter will have a direct effect on the operating temperature of the compressor. So you must be sure to maintain it.

### AIR/OIL SEPARATOR

This unit utilizes a spin-on air/oil separator to make maintenance much more convenient than the element in vessel design. This does not diminish its operating efficiency. In fact the separation of the element from the pre-separation tank enhances the performance. The purpose of the separator is to remove aerosols. The vapor pressure of the oil, the operating temperature of the unit, operating pressure of the unit and the operating cycle will affect its performance.

### MINIMUM PRESSURE VALVE

As the compressed air leaves the compressor it goes through a minimum pressure valve. This is set to maintain at least 85 psig (586kPa) in the sump when the compressor is running. This is to insure that there is pressure to force the oil out of the sump and through the oil system so that sufficient oil is injected into the compressor. It is also necessary to provide good air/oil separation. The valve acts as a check valve to prevent back flow into the compressor from the plant system.

## COOLING

The compressor has an air-cooled and after-cooler as standard. The following are the heat loads and cooling airflow rates that must be accommodated.

The compressor is an oil flooded unit. The oil lubricates, seals, and cools the internals of the compressor. In cooling it picks up the heat generated by the compression process and the mechanical friction from the bearings. So the oil must be cooled to within 60 degrees Fahrenheit of the ambient temperature.

The after-cooler has been designed for a minimum approach of 15 degrees F

## HEAT LOAD OF COMPRESSOR

MODEL	TOTAL HEAT LOAD B/Min	REQUIRED FLOW CFM
5-7.5hp	805	1767
10hp	1064	2335
15hp	1587	3483
20hp	2104	4619
25hp	2727	5985
30hp	3250	7134
40hp	4256	9341
50hp	5325	11,700
60hp	6390	14,040
75hp	7988	17,550
100hp	10,650	23,400
125hp	13,313	29,250
150hp	15,975	35,100
200hp	21,300	46,800
250hp	26,625	58,500
300hp	31,950	70,200

## Controls

The RS series of units is equipped with a normally closed inlet valve. This means that when the unit is started, the inlet valve remains closed while the unit builds up pressure by means of a bypass line. After startup the inlet valve is controlled by a simple on/off action of a pressure switch working with a solenoid valve.

For instrumentation the unit has a discharge temperature gauge, air pressure gauge.

## Installation

### GENERAL

The standard RS series was designed for indoor applications. For outdoor applications consult the factory for modifications. Failure to obtain factory approval will void the warranty.

### FOUNDATION

Your Compressed Air Systems LLC rotary screw compressor does not require a special foundation. However, it is necessary that the floor be level and the frame adequately supported. Consult the SPECIFICATIONS section of this manual for the compressor weight and dimensions. We do recommend that the compressor be bolted to the floor. We recommend the compressor be mounted on vibration reduction pads

### ROOM

The room should be of adequate size to provide full access to the machine for routine maintenance. It should have ventilation to keep the room as cool as possible. Operating at elevated temperatures will cause nuisance overload and temperature shutdowns. Room temperature should not exceed 105° F.

### AIR INTAKE

To achieve the longest filter and lubricant life and the least maintenance you need to supply the compressor with the cleanest air possible. It must not contain any flammable or toxic gases. These will be concentrated by the compressor, and could result in personal injury or death and property damage.

	<p><b>Inlet containing reactive gases will cause the failure of the lubricant and compressor.</b></p> <p><b>Insure an air supply that is well clear of any reactive gas source.</b></p>
--	---

If it is necessary to take air from a remote source, the piping should be at least the diameter of the air filter inlet. For distance over twenty feet the diameter needs to be enlarged to reduce the restriction. This pipe should also be corrosion resistant and free from scale and dirt. The inlet should also be covered to prevent rain and small animals from entering.

## Receiving and Uncrating of your Compressor

### BEFORE UNCRATING THE COMPRESSOR THE FOLLOWING STEPS SHOULD BE TAKEN.

1. Immediately upon receipt of the equipment, it should be inspected for damage that may have occurred during shipment. If any damage is found, demand an inspection immediately by an inspector from the carrier. Ask him/her how to file a claim for damages. (Never attempt to move compressor without proper lifting equipment).
2. Insure that adequate lifting equipment is available for moving the machinery.
3. Read the compressor nameplate to be sure the compressor is the model and size ordered.
4. Read the motor nameplate to be sure the motor is compatible with your electrical conditions. (Volts-Phase-Hertz).

**IMPORTANT:** If voltage supplied to the compressor is below 208 volts the unit need a 200 Volt drive motor and 208-230-460 Volt should not be used below 208 volts.

**NOTE:** Standard motors are open drip proof with a maximum ambient temperature rating of 104 degrees F. They are not suitable for salt laden, corrosive, dirty, wet, or explosive environments.



**CAUTION**

Improper lifting can result in component or system damage or personal injury.

Follow good shop practices and safety procedures



**CAUTION**

Under no circumstances should a compressor be placed in an area that may be exposed to a flammable, toxic, volatile or corrosive atmosphere nor should flammable, toxic, volatile or corrosive agents be stored near the compressor.

## Compressor Installation

### LOCATION

Locate the compressor in an indoor area that is clean, dry, well lighted, and well ventilated, with sufficient space for safe and proper inspection and maintenance. Ambient temperatures should not exceed 104 degrees F or fall below 30 degrees unless an electric motor rated for a higher temperature is used. Inspection and maintenance checks are required daily, therefore, ample space is required around the compressor.

The compressor must not be installed closer than 24 inches from a wall or from another compressor to allow ample circulation of air across the compressor cylinders and head, and through the coolers if they are part of the system. Additional safety can be achieved by locating the pulley guard next to the wall.

### MOUNTING

The use of the factory supplied rubber vibration isolation pads, or other factory supplied vibration isolation mounting equipment is required for tank warranty from the original tank manufacturer. The compressor should never be left on original shipping material for installation. If a shim is required to level the unit, place it between the pad and floor. If you bolt the unit to the floor, use the bolts as guide pins and do not tighten the bolts. The rubber pads are used to absorb machine vibration and cannot work effectively if bolted tightly.

### INDUCTION SYSTEM

Do not locate the compressor where it could ingest or ignite toxic, explosive or corrosive vapors, ambient air temperatures exceeding 110 degrees F, water or extremely dirty air. Ingestion of any of the above noted atmospheres by the compressor could jeopardize the performance of the equipment and all personnel exposed to the total compressed air system.

Destructive pulsations can be induced by reciprocating compressors that will damage walls and break windows. Pulsation can be minimized by adding a pulsation dampener on the inlet side of the compressor.

**For compressor tank to have full manufacturer warranty. The tank must be installed properly on manufacturer supplied vibration pads per compressor manual. Failure to do so can void compressor tank warranty and cause tank cracks or failures.**

**On Electric compressors all electrical connections must be wired and installed per NEC (National Electric Code) (See the back of the manual for NEC code) and all local applicable codes for full electric component warranty. Failure to do so can void compressor electrical warranty.**



## Installation Continued

### COOLING AIR DISCHARGE

The cooling air discharge must be restriction free. Any louvers or ducting must not exceed a quarter of an inch static head. Above this a booster fan will be required. Consult a local HVAC contractor for recommendations prior to installation. Excessive restriction to the cooling air discharge will cause the unit to operate at elevated temperatures that could result in high temperature shutdowns.

Ducting of cooling air to the unit is not generally recommended.

### ELECTRICAL

A qualified electrician in compliance with standards and local codes should do all electrical wiring. Be sure to investigate the local requirements before installing the compressor.

The power supply should be adequate and free of parasitic loads that will cause an under voltage condition during the operation of the compressor, otherwise there will be nuisance electrical shutdowns. Always connect the compressor to its power source through a fusible disconnect and insure the unit is properly grounded.

### UNPACKING AND HANDLING

Occasionally damage will occur during shipping. Be sure to carefully inspect the unit before unpacking. After unpacking before you sign the receiver, if anything damage has occurred, document it with the trucking firm immediately. Contact your Compressed Air Systems LLC. representative for assistance.

To move your compressor to its installation site we recommend that you leave the unit on its shipping skid as long as possible. The forks should be extended the width of the compressor and padding should be placed between the compressor and the truck boom.

If it is necessary to lift the compressor with a crane, we recommend the use of the spreader bar and chains. The spreader bar should be greater than the width of the compressor and padding is placed on the edges to prevent chain damage. Consult the installation drawing at the end of this section for the center of gravity.

### STORAGE

In some cases it may be necessary to store the compressor for extended periods of several months before placing the unit in operation. When this is required do the following:

Cover and seal all machine openings to prevent the entrance of water and dirt.

Cover all openings in open drip proof motors to prevent the entrance of rodents.

If the storage conditions are below freezing; drain the after cooler, traps, water-cooled heat exchanges and attendant piping. We do not recommend outside storage.

Cover with a waterproof tarpaulin that can easily be removed for in-storage maintenance.

While in storage, every two or three months, rotate the compressor and motor by hand to prevent flat spots on the bearings that will lead to premature failure.

At the end of the storage period, follow the uncrating and start-up procedures. If the unit has been stored for more than eighteen months, you should contact Compressed Air Systems before restarting the compressor.

## Guidelines for Compressed Air Systems

- The air pressure drop between the compressor and the point of use is not recoverable.
- Pipe size should be large enough that the pressure drop does not exceed 10% between the air receiver and the point of use.
- Arrange the air distribution piping to avoid the following types of strain:
  - Strains that are due to dead weight of the pipe itself.
  - Strains that are due to expansion or contraction of the piping due to temperature.
  - Strains due to internal pressure within the pipe.
- Design inlet and discharge piping for smooth airflow.
- Plan for future emergencies and establish an area of the loop to install a temporary compressor.
- Consider a second receiver at the end of the line or opposite side of the loop.
- Use loop-piping systems; if possible, both around the plant and within the loop.
- Consider a second receiver at the end of the line or opposite side of the loop.
- Locate runaways from the main header close to the point of application.
- Take air off the top of the header to prevent carryover of condensed moisture to tools.
- Slope piping so that it drains toward a drop leg or moisture trap away from the compressor.

## Operation

Every Compressed Air Systems LLC compressor has been operated and thoroughly tested at the factory prior to shipment. The test assures that the compressor will deliver its rated capacity and is in good working order. However, there is the possibility that damage may occur in shipping. For this reason, it is recommended that the unit be carefully inspected for evidence of damage or malfunction before installation and during the first hours of operation.

### PREPARATION FOR INITIAL START-UP

1. Pull the main disconnect switch and ensure that there is no power to the unit.
2. Review the installation instructions to see that everything is complete.
3. Inspect for visible signs of damage that could have happened during shipment or installation.
4. Make certain protective coverings required for shipment or painting are removed from the compressor.
5. Fill the sump to the proper oil level. Do not overfill, if it is, drain to proper level. Tighten the fill cap securely.
6. Reconnect the main disconnect.
7. Refer to control section and check out panel components.
8. "Jog" the motor (press start and stop in quick succession) and check for the correct direction of rotation. Reverse LS1 and L2 connections if incorrect.
9. Start the unit and run for several minutes, then shutdown. Check the oil level and add, if necessary, to compensate for filling the system.
10. Begin normal operation



**CAUTION**

**Reverse rotation will cause air end damage. Exchange leads L1 and L2, if reverse rotation.**

## NOISE

Noise is a potential health hazard that must be considered. There are local and federal laws specifying maximum acceptable noise levels that must not be exceeded. Most of the noise from a reciprocating compressor originates from the air inlet point. Excessive noise can be greatly reduced by installing an intake noise silencer. Intake noise silencers are available from the compressor manufacturer.

## PIPING FITUP

Care must be taken to avoid assembling the piping in a strain with the compressor. It should line up without having to spring or twist into position. Adequate expansion loops or bends should be installed to prevent undue stresses at the compressor resulting from the changes between hot and cold conditions. Pipe support should be mounted independently of the compressor and anchored as necessary to limit vibration and prevent expansion strains.



**Safety valves are to protect system integrity in accordance with ASME Codes and ANSI B19.3 safety standards. Failure to use safety valves of the proper capacity and pressure will cause severe personal injury or death.**

**NOTE:** Standard motors are open drip proof with a maximum ambient temperature rating of 104 degrees F. They are not suitable for salt laden, corrosive, dirty, wet, or explosive environments.

**SAFETY VALVES:** Safety valves are pressure relief valves and should be sized and purchased with a pressure setting to protect the weakest link in the system. Never change the pressure setting, only the safety valve manufacturer is qualified to make a change. Safety valves are to be placed ahead of any potential blockage point which included but is not limited to, shutoff valves, heat exchangers, pulsation dampeners, and discharge silencers.

**Failure to properly size, set and install pressure relief valves can be fatal.**

	<p><b>ASME coded pressure vessels must not be modified, welded, repaired, reworded or subjected to operation conditions outside the nameplate ratings. Such actions will negate code status, affect insurance status and may cause severe personal injury, death, and property damage.</b></p>
--	--

### **PRESSURE VESSELS**

Air receiver tanks and other pressure containing vessels such as, but not limited to, pulsation bottles, heat exchangers, moisture separators and traps, shall be in accordance with ASME Boiler and Pressure Vessel Code Section VIII and ANSI B19.3 Safety Standards.

	<p><b>The installation, wiring, and all electrical controls must be in accordance with ANSI C1 National Electric Code, ANSE C2 National Electric Safety Code, state and local codes. All electrical work should be performed by a qualified electrician. Failure to abide by the national, state and local codes may result in physical and/or property damage.</b></p>
---	---

### **ELECTRICAL**

Before installation, the electrical supply should be checked for adequate wire size, breaker size, transformer and capacity. During installation a suitable fused or circuit breaker disconnect switch should be provided. Where a 3 phase motor is used to drive a compressor, any unreasonable voltage unbalance between the legs must be eliminated and any low voltage corrected to prevent excessive current draw. Compressors must be equipped with a properly wired magnetic motor starter or a pressure switch rated to carry the full motor current load. The coil which engages and disengages the contact points in the motor starter is controlled by the pressure switch. Never attempt to bypass the pressure switch or adjust it past the factory set pressure range. Improper installation of the electrical system can cause the motor to overheat or a short circuit to occur.



Electric power always exists inside the pressure switch when there is electric power at the compressor package. Either a qualified electrician should make the pressure adjustments or the electric power supply should be disconnected and locked out before making any adjustment.

**NEVER** exceed the designed pressure for the system or overload the motor beyond its service factor.

**FAILURE TO HEED THESE WARNINGS MAY RESULT IN SERIOUS INJURY OR DEATH, PROPERTY DAMAGE AND/OR MECHANICAL FAILURE**

### **PRESSURE SWITCH**

The pressure switch is automatic in operation and is adjusted to start and stop the unit at the minimum and maximum desired air receiver pressure by cutting in and out the power to the electric motor. On some models, the pressure switch incorporates a release valve, which releases air between the check valve located in the receiver and discharge valve in the head of the compressor.



Relieve compressor and system air pressure by opening the appropriate manual relief valve prior to servicing.

Failure to relieve all system pressure may result in severe personal injury, death and property damage.

### **MANUAL RELIEF AND SHUTOFF VALVES**

Install a manual relief valve to vent the compressor to atmosphere. In those instances where the air receiver tank services a single compressor, the manual relief valve can be installed on the receiver. When a manual shut-off valve, and a safety relief valve installed upstream from the manual relief valve. These valves are to be designed and installed as to permit maintenance to be performed in a safe manner. Never substitute a check valve for a manual shut-off valve (block valve) if the purpose is to isolate the compressor from a system for servicing.



Guards must be fastened in place before starting the compressor and never removed before cutting off and locking out the main power supply.

## GUARDS

All mechanical action or motion is hazardous in varying degrees and needs to be guarded. Guarding shall be in compliance with OSHA Safety and Health Standards 29 CFR 1910.219 in OSHA manual 2206 and any state or local code.



Excessive speed of the compressor or driver can be lethal. Never operate the compressor beyond the manufacturer's recommendation.

Bursting of the flywheel may be the greatest threat because the normal guard may not contain all the pieces.

Crankshaft and connecting rod breakage is a possibility and compressor efficiency, valve life and bearing life will be abnormally reduced.

## DRIVES

It is important that the compressor and motor pulleys are aligned properly and the V belt is correctly tensioned. Improper pulley alignment and belt tension are causes for motor overloading, excessive vibration, and premature belt and/or bearing failure.

**Removal or painting over safety labels will result in uninformed conditions. This may result in personal injury or property damage. Warnings signs and labels shall be provided with enough light to read, conspicuously located and maintained for legibility. Do not remove any warning, caution, or instructional material attached!**

**Provisions should be made to have the instruction manual readily available to the operator and maintenance personnel. If for any reason any part of the manual becomes illegible or if the manual is lost, have it replaced immediately. The instruction manual should be periodically read to refresh one's memory, it may prevent a serious or fatal accident.**

## Normal Operation

### START-UP

Drain off condensate from the sump and check the oil level. Refill as necessary.

Check for any oil leaks. Correct as necessary.

On water cooled units, turn on the water.

Press the start button.

### STOPPING

1. Make sure the compressor is fully unloaded before step 2. Unload the compressor by closing the service valve (this is a ball or block valve) placed in the system during compressor installation between the compressor and operating airlines for service and maintenance reasons.
2. After the unit has exhausted its contained pressure (this takes about 30 seconds) push the stop button.

### EMERGENCY STOPPING

1. Push the stop button.
2. Pull the main disconnect, if possible

### AIR FILTER

The air filter is the primary protection of the compressor from harmful dirt being ingested into the oil system. It needs to be looked at periodically for clogging or holes. The period for these inspections is dependent on the environment the machine is in. For optimum life it is recommended that an air filter restriction indicator be used. Service simply based on hours is not recommended.

### ELEMENT INSPECTION AND REPLACEMENT

Switch off the unit and disconnect the power to prevent accidental starting.

Allow one minute after stopping for the system to settle and the pressure to be relieved.

Loosen the nut that secures the cover and remove the cover.

Remove the element.

Place a bright light inside the element to inspect for damage or leak holes.

Inspect all gaskets and gasket contact surfaces of the housing. Correct any faulty conditions immediately.

Clean the housing with a damp cloth. Do not attempt to blow out dirt with compressed air.

Place a new element in the housing.

Replace the cover and tighten the nut.

Reset the filter indicator and the machine will be ready for operation.

If the compressor is turned off before being fully unloaded it can cause the unit to discharge oil into the air filter housing causing it to stop up or become contaminated.

### OIL FILTER

The oil filter in the compressor system is a full flow replaceable canister type. This element protects the compressor bearings from grit and dirt ingress throughout the system. A dirty filter will cause an oil flow restriction that can result in high oil temperature and a unit shutdown.

### OIL FILTER REPLACEMENT

1. Switch off the unit and disconnect the power to prevent accidental starting.
2. Allow one minute after stopping for the system to settle and the pressure to be relieved.
3. Using a strap wrench, remove the old element and gasket.
4. Clean the gasket surface with a clean rag.
5. Apply a light film of oil to the new gasket.
6. Hand tighten the new element until the new gasket is seated in the gasket groove.
7. Continue tightening by hand an additional  $\frac{1}{2}$  to  $\frac{3}{4}$  turn.
8. Reconnect power and restart the machine to check for leaks.



Hot oil under pressure will cause severe injury, death, or property damage.

Be sure the compressor is shutdown and pressure relieved before attempting to remove the oil filter, separator, oil fill, or change the oil.

### AIR/OIL SEPARATOR

The air/oil separator should be changed every 2000 hours, or when there is excessive oil vapor in the discharge air.

### SEPARATOR ELEMENT REPLACEMENT

1. Switch off the unit and disconnect the power to prevent accidental starting.
2. Allow one minute after stopping for the system to settle and the pressure to be relieved.
3. Using a strap wrench, remove the old element and gasket.
4. Clean the gasket surface with a clean rag.
5. Apply a light film of oil to the new gasket.
6. Hand tighten the new element until the new gasket is seated in the gasket groove.
7. Continue tightening by hand and additional  $\frac{1}{2}$  to  $\frac{3}{4}$  turn.
8. Reconnect power and restart the machine to check for leaks
- 9.
- 10.

### LUBRICANT

Your compressor has been filled and tested with CAS RS8000, a high quality compressor lubricant. It is a PAO with the advantage of extended service life, high temperature operation, easy start-up when cold, reduced sludge and lacquer buildup, and is completely compatible with all seals, gaskets, and other compressor materials.

### LUBRICANT SPECIFICATIONS

If you choose not to use CAS RS8000, for optimum life and warranty service your lubricant must meet the following specification:

Grade ISO	46
Viscosity@100oF,cST	46
Viscosity@210oF,cST	7.93
Viscosity Index	100 or more
Pour Point, F	-20 or less
Flash Point, F	400 or more
Fire Point, F	450 or more
Rust Test ASTM-FG-665 A&B	Pass
Oxidation Test, ASTM0-D943	1500
Emulsion Test, ASTM-D1401	10 Min.
Foam Test, ASTM	Pass

### OIL ANALYSIS

Oil analysis is an excellent tool to add to your compressor maintenance program. At regular intervals you submit lubricant samples to a qualified laboratory. From this you receive a detailed report showing the lubricant condition, wear metals, and contaminants. Changes in this information over time provides the basis for predictive compressor maintenance. Saving you unplanned machine downtime and unnecessary oil changes.



## CHECKING OIL LEVEL AND ADDING COMPRESSOR OIL

1. Switch off the unit and disconnect the power to prevent accidental restarting.
2. Allow one minute after stopping the compressor for settling and the pressure to relieve.
3. Remove any dirt from around the fill cap, then remove the fill cap.
4. Inspect the o-ring in the cap for damage and cleanliness. Replace if necessary.
5. The oil should be between the bottom of the neck and the o-ring groove or 1/2 full in sight glass.
6. Replace the cap securely. Never put the cap on without tightening immediately.

## CHANGING COMPRESSOR LUBRICANT

Regular maintenance of the oil filter and the air filter will help prolong the life of the lubricant.

1. Switch off the unit and disconnect the power to prevent accidental restarting.
2. Allow one minute after stopping the compressor for settling and the pressure to relieve.
3. Remove any dirt from around the fill cap, and then remove the fill cap. If the lubricant appears dirty or has a foul smell, it should be replaced.
4. Drain the lubricant from the bottom of the air/oil receiver. Oil will drain more quickly and completely if is warm from operation.
5. Close all drains and replace with fresh CAS RS8000 to the proper level.
6. Replace the fill cap and run the unit.
7. Switch off the unit and disconnect the power to prevent accidental restarting.
8. Allow one minute after stopping the compressor for settling and the pressure to relieve.
9. Remove the fill cap to see if more lubricant should be added and to insure that there are no leaks.

## OIL RETURN SIGHT GLASS

During loaded operation there should be a visible flow in the sight glass. If there are no droplets visible then the orifice in this line needs to be checked for plugging. Oil not returned ends up in the plant air system.

## MINIMUM PRESSURE VALVE

This minimum pressure valve is a non-adjustable spring biased check valve. It has been designed to maintain a minimum sump pressure of 85 psig. If the pressure is allowed to get too low, the oil carryover rate will increase and the separator could be damaged.

## TO CHECK THE BELTS

1. Switch off the unit and disconnect the power to prevent accidental restarting.
2. Allow one minute after stopping the compressor for settling and the pressure to relieve.
3. Remove the belt guard.
4. Inspect for any fraying or cracking of the belts. If there is any, replace the belts.
5. Check the tension. It should be about 1/64" per inch of span between the sheaves
6. To Change the Belts
7. Switch off the unit and disconnect the power to prevent accidental restarting.
8. Allow one minute after stopping the compressor for settling and the pressure to relieve.
9. Remove the belt guard.
10. Loosen the motor hold down bolts and the puller bolt and slide the motor toward the air end.
11. Remove the belt.
12. Replace with new belt.
13. Set the initial by sliding the motor back to its original position using the puller bolt and tighten the motor hold down bolts.

## FAN

Check the fan for cracking, loose rivets, and bent or loose blades. Make sure that it is securely mounted and tighten the mounting screws if loose. Replace a damaged fan immediately.

## Troubleshooting Chart

NOTE: Troubleshooting problems may have similar causes and solutions

**You should always contact an authorized service center before attempting to fix or repair your air compressor.**

**Always make sure electrical power is off before removing any inspection covers or plates or before servicing compressor.**

Problem	Possible causes	Solutions
Compressor will not start	<ul style="list-style-type: none"> <li>No power</li> <li>Fuse blown in control circuit</li> <li>Motor overloads not tripped or not reset</li> <li>Loose incoming or power connection wires</li> <li>Low voltage to unit</li> <li>Faulty temperature switch</li> <li>Temperature switch tripped</li> <li>High pressure switch tripped</li> </ul>	<ul style="list-style-type: none"> <li>Check power supply for adequate voltage</li> <li>Check fuses</li> <li>Make sure all power wires are tight at connections</li> <li>Check voltage supply to make sure it is high enough to run the electric system</li> <li>Check temperature switch for proper operation</li> <li>Check system pressure</li> </ul>
Unit starts-them immediately stalls	<ul style="list-style-type: none"> <li>Pressure switch out of adjustment</li> <li>Temperature switch activated</li> <li>Loose electrical supply wires</li> <li>Motor overloads tripped</li> <li>Low voltage</li> <li>Incorrect compressor rotation</li> </ul>	<ul style="list-style-type: none"> <li>Check compressor power supply for adequate breaker and wire size</li> <li>Inspect check valve for proper operation</li> <li>Tighten belts</li> <li>Check compressor for proper oil level</li> </ul>
Low discharge pressure	<ul style="list-style-type: none"> <li>Plugged separator</li> <li>Plugged oil cooler</li> <li>Improper pressure switch setting</li> <li>Low incoming power voltage</li> <li>Electrical phase imbalance</li> <li>Possible airend or motor failure</li> </ul>	<ul style="list-style-type: none"> <li>Tighten compressor belts to recommended specifications</li> <li>Check compressor voltage supply</li> </ul>

## Troubleshooting Chart (continued)

**NOTE:** Troubleshooting problems may have similar causes and solutions

**You should always contact an authorized service center before attempting to fix or repair your air compressor.**

**Always make sure electrical power is off before removing any inspection covers or plates or before servicing compressor.**

Problem	Possible causes	Solutions
Compressor does not build up to pressure	<ul style="list-style-type: none"> <li>Air leaks in shop</li> <li>Inlet valve malfunction</li> <li>Compressor belts slipping</li> <li>Air demand exceeds compressor output</li> <li>Pressure switch set to low</li> <li>Solenoid valve malfunction</li> <li>Compressor rotors damaged</li> </ul>	<ul style="list-style-type: none"> <li>Find and fix shop air leaks</li> <li>Check inlet valve for proper function</li> <li>Check air usage requirements on machinery and check for shop air leaks</li> <li>Check pressure switch for proper setting</li> <li>Check solenoid for proper function</li> </ul>
Compressor will not load to compress air	<ul style="list-style-type: none"> <li>Pressure switch set to high</li> <li>Inlet valve malfunction</li> <li>Faulty solenoid</li> </ul>	<ul style="list-style-type: none"> <li>Check pressure switch for proper setting</li> <li>Check inlet valve for proper function</li> <li>Check solenoid for proper function</li> </ul>
CFM Flow (air flow) seems low	<ul style="list-style-type: none"> <li>Restricted air intake filter</li> <li>Inlet valve partially closed</li> <li>Air pressure set to high</li> <li>Insufficient oil flow</li> <li>Solenoid valve malfunction</li> </ul>	

## Troubleshooting Chart (continued)

NOTE: Troubleshooting problems may have similar causes and solutions

**You should always contact an authorized service center before attempting to fix or repair your air compressor.**

**Always make sure electrical power is off before removing any inspection covers or plates or before servicing compressor.**

Problem	Possible causes	Solutions
Excessive oil consumption	<ul style="list-style-type: none"> <li>Over filled sump</li> <li>Broken oil line</li> <li>Plugged oil return line</li> <li>Damaged or dirty separator</li> <li>Excessive unloaded compressor run time</li> </ul>	<ul style="list-style-type: none"> <li>Check sump for proper oil level</li> <li>Check all lines for cracks</li> <li>Replace separator</li> <li>Add a timer to the system</li> </ul>
High temperature shutdown	<ul style="list-style-type: none"> <li>High ambient air temperature around compressor</li> <li>Low oil level in compressor</li> <li>Plugged oil filter</li> <li>Restricted air flow over cooler</li> <li>Thermal by pass leaking</li> <li>Faulty temperature switch</li> </ul>	<ul style="list-style-type: none"> <li>Lower ambient temperature around compressor</li> <li>Check unit for proper oil level</li> <li>Replace oil filter</li> <li>Clean oil cooler</li> <li>Check thermal bypass for proper operation</li> <li>Check temperature switch for proper operation.</li> </ul>
High amperage draw	<ul style="list-style-type: none"> <li>Restricted air intake filter</li> <li>Inlet valve partially closed</li> <li>Air pressure set to high</li> <li>Insufficient oil flow</li> <li>Solenoid valve malfunction</li> </ul>	<ul style="list-style-type: none"> <li>Change separator</li> <li>Clean oil cooler</li> <li>Check pressure switch</li> <li>Check incoming voltage</li> <li>Check air end and motor for proper function</li> </ul>

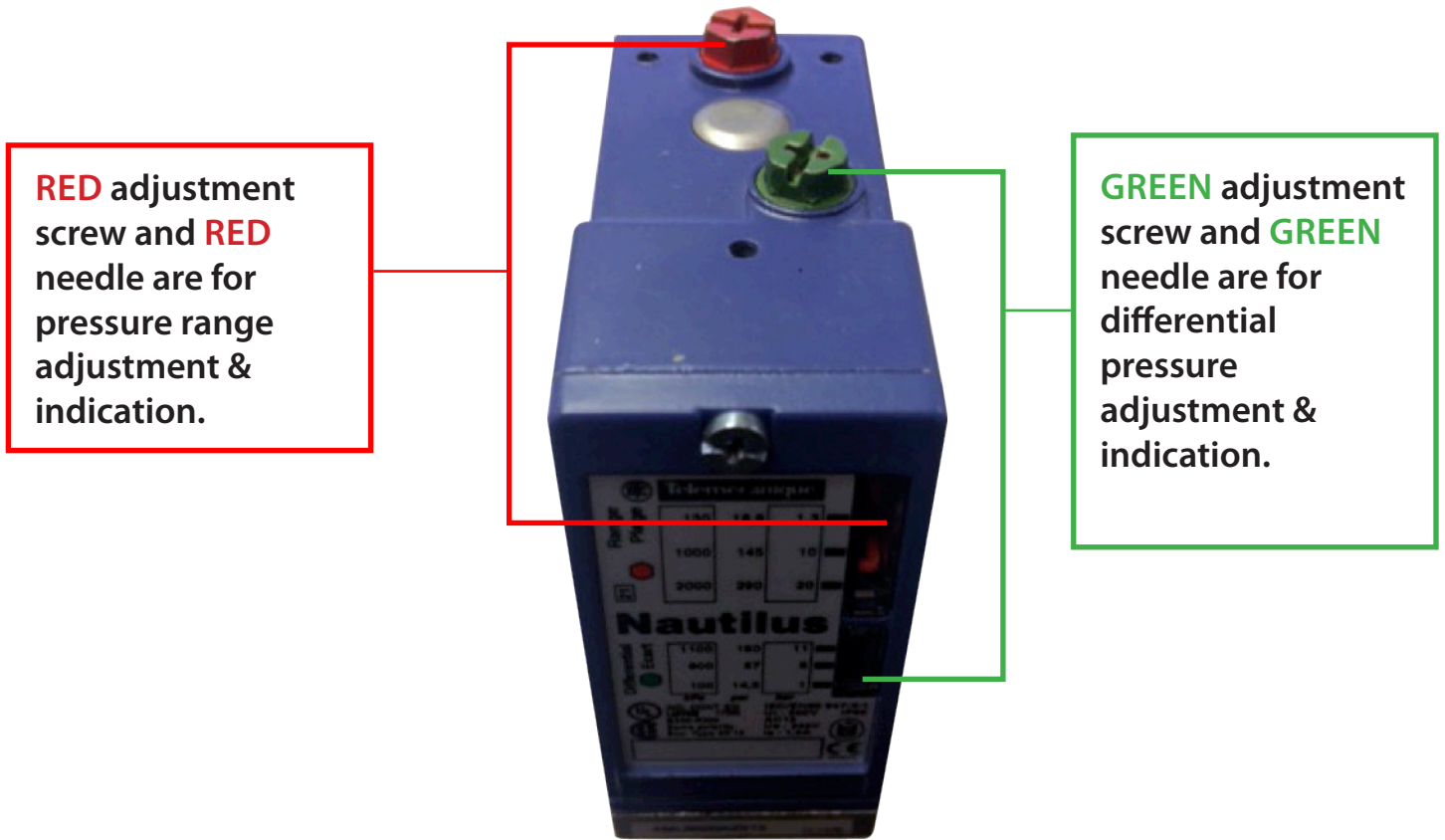

Turn **RED** adjustment screw clockwise to increase operating pressure. Turn **RED** adjustment screw counterclockwise to decrease operating pressure.

Turn **GREEN** adjustment screw clockwise to increase differential pressure. Turn **GREEN** adjustment screw counterclockwise to decrease differential pressure.

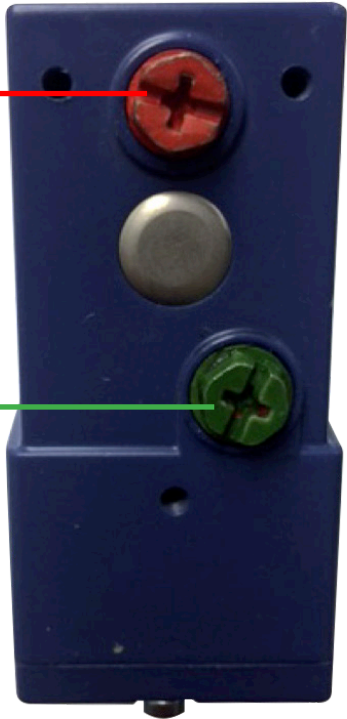

## Stopping for Maintenance or Service

	<p><b>Never assume the compressor is ready for maintenance or service because it is stopped.</b></p> <p><b>The automatic stop-start control may start the compressor at any time!</b></p>
--	---

The following procedure should be followed to maximize safety when preparing for maintenance or service.

1. Disconnect and lock-out the main power switch and hang a sign at the switch Informing of the unit being serviced.
2. Close shut-off valve (block or ball valve) between compressor and main supply (air tank or air lines). This is the valve installed to isolate the air compressor for maintenance or service. The valve is placed in the system during installation for the purpose of servicing the compressor and to not allow (shop or working) air back into the compressor during service. \*See note for turning compressor off while under a load or compressing air.
3. Lock open manual vent valve and wait for the pressure in the area to be serviced (compressor, receiver, etc.) to be completely relieved before starting service. The Manual vent valve may be the drain valve in the receiver. NEVER remove a plug to relieve the pressure.
4. Open all manual drain valves within the area to be serviced.
5. Wait for the unit to cool before starting service, (temperatures at 125 degrees F can burn the skin), some surface temperatures exceed 400 degrees F when the compressor is working).
6. Clean up all oils spills immediately to prevent slipping (Mark spill area accordingly).

\* Note. If the compressor is turned off before being **FULLY UNLOADED** it can cause the unit to discharge oil into the air filter housing and could cause the air filter element to become contaminated. This may happen when using the emergency shut-off button and/or the on/off switch

## Adjusting Belt Tension

Proper belt tension and pulley alignment must be maintained for maximum drive efficiency and for maximum belt life. The correct tension exists if a deflection of  $\frac{1}{2}$  inch occurs by placing 10lbs of force midway between the motor pulley and the compressor flywheel. This deflection can be adjusted by the following procedure. The pulley should be carefully aligned with the flywheel and set screws should be kept tight.

1. Remove the belt guard
2. Loosen the motor mounting bolts
3. Shift the motor to the point where the correct deflection exists
4. Retighten the motor mounting bolts
5. Check to ensure that the tension remain correct after tightening
6. Re-install the belt guard. All moving parts must be guarded

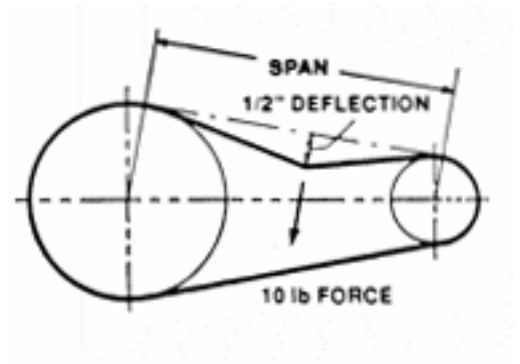

NOTE: Drive belt tension and pulley alignment are done at the same time. They are discussed separately for clarity.

## Pulley Alignment

The figure to the side shows 3 examples of misaligned pulleys. To check pulley alignment, remove the belt guard and place a straightedge against the compressor flywheel, measure and record the distance from the straightedge to the edge of the drive belt. Then measure the distance to the edge of the drive belt on the motor pulley at the same edge. As long as both points measure the same distance the pulleys will be aligned if not you will need to move the pulley until its in alignment this may take a few tries. To re-align the pulley follow the steps below

1. Loosen the motor mounting bolts
2. Remove the belt guard
3. Loosen the set screw on the motor pulley
4. Align the motor pulley with the compressor flywheel
5. Re-tighten the motor pulley set screws
6. Adjust the proper belt tension
7. Re-tighten the motor mounting bolts
8. Re-install the belt guard

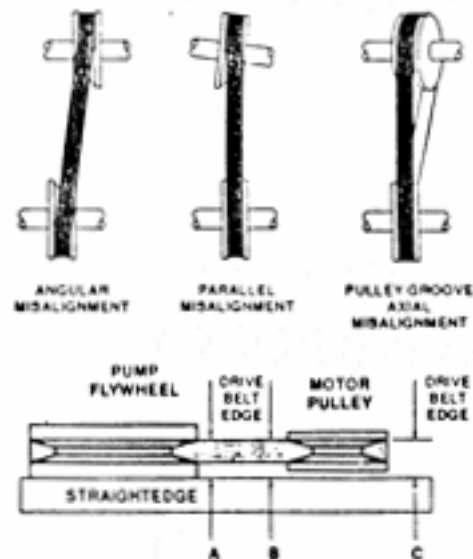

## Compressor Maintenance

**WARNING:** To avoid personal injury, always shut OFF the main power supply and disconnects to the compressor, relieve all air pressure from the system, and check electrical system with electrical probe before starting any service or maintenance on the compressor.

### Daily:

**Check Airend Oil Level:** remove oil fill cap and check for proper level. Oil should be half way up the at the bottom or half way up the threads on the oil fill

**Drain the Receiver:** condensation will accumulate in the tank daily, and should be drained at least once a day. This is done to reduce corrosions of the tank from the inside. Always wear protective eyewear when draining the tank.

**Check Oil Cooler:** check cooler for proper air flow to keep unit cool clean if necessary

Check unit for any unusual noise or vibrations

### Weekly:

**Clean air filter:** this will ensure that no dirt or heavy particulate makes its way into the compressors valve assemblies

**Clean external parts** of compressor and electric motor: this helps to ensure proper cooling and prevents rust and corrosion on critical parts

**Check safety Valves:** this is don't to ensure they are not stuck in place and operating properly

### Monthly:

**Inspect complete air system** for leaks: this is done to make sure the compressor does not get out of its duty cycle due to air leak in the system

**Inspect Oil** for Contamination: this is done to ensure that harmful deposits do not build up in the oil

**Check belt tension:** this is done to ensure the belt do not fail pre-maturely, tighten them as needed to ensure they do not slip

### Every 3 months (every 500hrs):

**Change oil filter:** this is done to ensure that the compressor has proper oil level and that the oil in the machine does not deteriorate past factory specifications

**Check airend filter** and change as needed.

### Yearly (every 2000 hrs)

**Change oil:** change with only CAS RS 8000

**Clean Oil Cooler:** this is done to ensure adequate cooling for the compressor air end.

### Storage of Compressor:

Before storing the compressor for a prolonged period of time, use a blow gun to clean all debris from compressor. Shut OFF main power and turn OFF disconnect. Drain tank pressure, clean air filter, drain old oil and replace with new oil. Cover the unit to prevent dust and moisture from collecting on the unit.



## Maintenance Procedures Review

### SAFETY PROCEDURES.

Adherence to safe working procedures are important to Service personnel at the time of servicing and to those who may, at a later date be around the compressor and the system it serves. Routine maintenance insures trouble free operation and protects your investment. All warranties are void if maintenance is neglected.

#### Daily:

##### CHECK THE OIL LEVEL.

Oil should be half up, or at the bottom of the threads on the fill spout, or 1/2 full in the sight glass.

##### DRAIN THE TANK.

Turn off the power to the compressor and drain all the moisture from the bottom of the tank.

#### Weekly:

##### CHECK THE OIL.

If the oil appears contaminated by moisture or dirt, change immediately.

##### CHECK THE BELTS.

Turn off the compressor and inspect the belts for damage, excessive wear, and correct tension. Replace if necessary.

##### TEST THE SAFETY VALVE.

Pull the ring on the safety valve. Air should escape and then reset. In the event the compressor ran over pressure, the safety valve would reduce the tank pressure to a safe level. Never run the unit without this safety valve or attempt to adjust it.

##### GENERAL INSPECTION.

Check the overall operation of the unit. Tighten any loosen bolts, inspect for air leaks and inspect for any unusual noises or vibrations.

##### INSPECT COMPRESSOR INTAKE.

NEVER use gasoline, thinners or other flammable solutions to clean valves or related parts. Check to be sure the valves are seated against the sealing surface around each port. If the valves are not sealing, compressor capacity will be severely reduced.

ROTARY SCREW COMPRESSOR CONSUMABLES	AIR FILTER	OIL FILTER	SEPERATOR	OIL CAPACITY (GALLONS)
NK30	NK30AF	NK30OF	NK30SE	1
NK31	NK30AF	NK30OF	NK30SE	1
NK40	NK30AF	NK30OF	NK30SE	1
NK60	NK60AF	NK60OF	NK60SE	1.5
NK100	NK100AF	NK100OF	NK100SE	2.5
NK160	NK160AF	NK160OF	NK160SE	5
NK200	NK160AF	NK200OF	NK100SE (x2)	10
EVO3	EVO3AF	EVO3OF	EVO3SE	1.5
EVO6	EVO6AF	EVO6OF	EVO6SE	2.5
EVO9	EVO9AF	EVO9OF	EVO9SE	5
GCU11	GCU11AF	GCU11OF	GCU11SE	1.25
GCU30	GCU30AF	GCU30OF	GCU30SE	2.5

# Certificate of Limited Warranty

## Rotary Screw Compressors

All component parts on this compressor installed by the manufacturer are warranted to be free of defects, workmanship and material for a period of one year. Transportation charges are the responsibility of the purchaser. This warranty extends to the original purchaser of the compressor only.

There are NO express warranties except other than those contained in this limited warranty statement.

Covered in the one year period of the warranty are defective parts due to defects in the original part only.

The compressor warranty is void in the cases of abuse, lack of proper service, in correct application, in correct installation, and neglect.

Standard compressor warranty covers defective parts and labor for the one year period.

Industrial electric stationary compressors may be repaired on site as long as the compressor is not located further than 50 miles from the service center. The purchaser is responsible for any additional travel expense past 50 miles from the service center.

Gas/Diesel engine driven compressors **must be repaired at the closest service center to the compressor.** The purchaser is responsible for any travel expense if they do not wish to bring the compressor to the service center.

**ALL "SPECIALTY COMPRESSOR" WARRANTY SERVICE MUST BE PERFORMED AT THE CLOSEST SERVICE CENTER TO THE COMPRESSOR**

**Specialty compressor** -any compressor package with options other than those that apply to the standard model number in the catalog.

**Airend** - the rotors and bearings of the compressor.

The compressor "airend" is covered by a 2 year warranty to be free from defects from manufacturing. This does not cover abuse, neglect, improper service, misapplication, or improper installation. An oil sample must be submitted with any airend warranty claim for verification. The purchaser must use only Compressed Air Systems synthetic rotary screw oil in the compressor for the duration of the warranty.

**ALWAYS CONTACT MANUFACTURER TECH SUPPORT FOR FASTEST SOLUTION BEFORE WARRANTY SERVICE IS PERFORMED.**

**WARRANTY LABOR FOR THE FIRST YEAR IS ONLY COVERED FOR WORK PERFORMED MONDAY-FRIDAY 8AM-5PM EXCLUDING ALL MAJOR US HOLIDAYS.**

### Optional 5 year "airend" warranty

**To be applicable for this option the purchaser must purchase a Full year Rotary Screw compressor service kit at the same time as the compressor and a subsequent kit every year afterwards for a total of 5 kits during the compressor warranty period.** The purchaser must use only Compressed Air Systems synthetic rotary screw oil in the compressor for the duration of the warranty.

The warranty covers the "airend" of the compressor for a period of 5 years parts replacement only, from any defect due to manufacturing. The warranty does not cover wear and tear, abuse, neglect, improper service, misapplication, or improper application.

## Important

**Always contact manufacturer tech support for fastest solution before warranty service is performed.**

**Before warranty service can be performed on a unit the servicing company must contact the manufacture to get a warranty procedure verification number. Without a warranty verification number work may not be covered by the manufacturer under warranty. A warranty verification number does not guarantee a part or piece of the product is warrantable but guarantees it will be reviewed for warranty credit.**

**All warranty replacement parts must be Industrial Gold OEM part unless authorization is given from Industrial Gold factory representative.**

**Rotary Screw Compressor Installation Sheet**

Date of Installation \_\_\_\_\_ Compressor Model# \_\_\_\_\_

Installation Company \_\_\_\_\_ Compressor Serial # \_\_\_\_\_

Installation Technician \_\_\_\_\_ Compressor Voltage \_\_\_\_\_

Site Electrical Phase \_\_\_\_\_ Site Voltage L1 \_\_\_\_\_ L2 \_\_\_\_\_ L3 \_\_\_\_\_

Compressor Electrical breaker size \_\_\_\_\_

Incoming Voltage at motor start up L1 \_\_\_\_\_ L2 \_\_\_\_\_ L3 \_\_\_\_\_

Incoming Voltage at max operating pressure L1 \_\_\_\_\_ L2 \_\_\_\_\_ L3 \_\_\_\_\_

Incoming power connected to Magnetic Starter \_\_\_\_\_

Breaker size for the compressor \_\_\_\_\_AMPS Wire size for the compressor \_\_\_\_\_

Distance from main electric panel \_\_\_\_\_ Disconnect installed at the compressors site \_\_\_\_\_

If Duplex compressor separate disconnects for each drive motor:  Yes  No

Compressor Rotation Correct  Yes  No

Motor amps at Max operating Pressure L1 \_\_\_\_\_ L2 \_\_\_\_\_ L3 \_\_\_\_\_

Compressor Max Operating Pressure \_\_\_\_\_ Compressor tank drain functional \_\_\_\_\_

Unit inspected for Air leaks \_\_\_\_\_ Unit inspected for oil leaks \_\_\_\_\_

Unit location:  Indoors  Outdoors

Unit tank fill time 0-125psi \_\_\_\_\_ (Put N/A if pressure not applicable to installed unit)

Unit tank fill time 0-150psi \_\_\_\_\_ (Put N/A if pressure not applicable to installed unit)

Unit tank fill time 0-175psi \_\_\_\_\_ (Put N/A if pressure not applicable to installed unit)

Unit Cooling Fan  Pulls air through cooler  Push's air through cooler)

Compressor Temperature switch reading (Before install) \_\_\_\_\_ (After install) \_\_\_\_\_

Unit unloads at max operating pressure and begins to release sump pressure \_\_\_\_\_ -

Belt tension checked:  Yes  No Vibration Pads properly installed:  Yes  No

All installation steps completed:  Yes  No If no, reason: \_\_\_\_\_

Send copy of completed installation sheet to manufacture to begin warranty

Compressed Air Systems, LLC

2626 Skyway Drive

Grand Prairie, TX, 75052

## 5-15 HP Electric Rotary Screw Compressors

### NEC (National Electric Code) Guide Lines

1 Phase Motor Requirements (Copper wire must be THW, THHN-THWN, XHHW) No solid core wire

**NOTE:** Wire size is based on being within 30ft of main electrical panel installation further would need a qualified electrician to properly size the wire to account for voltage drop

Horse Power	Voltage	Instantaneous Trip Circuit Breaker Rating	Circuit Breaker Trip Rating	Minimum Wire Size
1.5	115	30	40	12
1.5	230	15	20	14
2	115	50	50	10
2	230	30	30	14
3	115	50	70	8
3	230	30	40	12
5	230	50	60	10
7.5	230	70	80	8
10	230	90	100	4

NOTE: Some rotary screw compressors have additional drive motors for the coolings fans these need to be taken into account when sizing the electrical system

3 Phase Motor Requirements (Copper wire must be THW, THHN-THWN, XHHW) No solid core wire

**NOTE:** Wire size is based on being within 30ft of main electrical panel installation further would need a qualified electrician to properly size the wire to account for voltage drop

Horse Power	Voltage	Circuit Breaker Trip Rating	Minimum Wire Size	Horse Power	Voltage	Circuit Breaker Trip Rating	Minimum Wire Size
3	200	20	14	30	200	150	2
3	230	20	14	30	230	125	3
3	460	15	14	30	460	80	8
3	575	15	14	30	575	60	8
5	200	35	12	40	200	200	1/O
5	230	30	14	40	230	175	1
5	460	15	14	40	460	100	6
5	575	15	14	40	575	80	6
7.5	200	50	10	50	200	200	3/O
7.5	230	45	10	50	230	200	2/O
7.5	460	20	14	50	460	125	4
7.5	575	20	14	50	575	100	6
10	200	60	8	60	200	250	4/O
10	230	60	10	60	230	225	3/O
10	460	35	14	60	460	125	3
10	575	25	14	60	575	125	4
15	200	90	6	75	200	300	300
15	230	80	6	75	230	300	250
15	460	45	10	75	460	150	1
15	575	40	12	75	575	125	3
20	200	100	4	100	200	400	500
20	230	90	4	100	230	400	350
20	460	60	10	100	460	200	2/O
20	575	50	10	100	575	175	1
25	200	125	3				
25	230	125	4				
25	460	70	8				
25	575	60	10				

NOTE: Some rotary screw compressors have additional drive motors for the coolings fans these need to be taken into account when sizing the electrical system

**WARNING:** Always wear proper protective eye ware, hearing protection and safety clothing when working around the compressor package. No loose or baggy clothing should be worn around compressor package at any time.

**WARNING:** On Electric motor powered air compressors make sure electrical system is up to National Electric Code (NEC) prior to installing compressor system. Failure to install a compressor with a proper NEC electrical system can cause personal injury, compressor package damage and void compressor package warranty

**NOTICE:** To ensure full compressor tank warranty all tank mounted compressor packages must be mounted on factory approved vibration isolation pads. A compressor should NEVER be installed while still on or in its original packaging. Failure to properly install the compressor system with approved vibration isolation pads will result in the compressor tank warranty being void.

**WARNING:** Compressed Air Systems compressors can operate at pressures from 0-250psi depending on the compressor package design and build specifications. Always verify that the system the compressor is installed into can handle the maximum operational pressure the compressor. NEVER install a compressor in a system that can not handle the compressors maximum operating pressure.

**WARNING:** Compressed air is extremely dangerous when not properly used or installed. Always make sure a trained compressed air professional has looked over the air system prior to use. Improper installation or use of compressed air can cause bodily injury or death. NEVER pressurize an object that was not designed to be pressurized. Pressurizing objects not properly engineered for the maximum operating pressure of the compressor system can cause bodily injury or death.

## Additional Information

For compressor pump information see pump specific manual.

For installation instructions see Install Guide.

For compressor package wiring diagram contact manufacturer.

For compressor parts breakdown see website ([compressed-air-systems.com](http://compressed-air-systems.com)) or contact compressor manufacturer.

On electric driven compressors always follow NEC (National Electric Code) on any local applicable code that exceeds NEC guidelines.

On gas/diesel engine driven packages follow engine manufacturer guide for proper placement and installation of engine driven equipment.







**Quality Air Compressor at a Great Price.**

2626 Skyway Drive  
Grand Prairie, TX, 75052

417-206-6353

800-742-3071

Fax 417-206-6336