

INSTRUCTION MANUAL

Corrosion Resistant Models HF(grade)-12 through HF(grade)-36

High Pressure Model HF(grade)-24 and HF(grade)-32

Contents

MODEL NUMBER CONFIGURATION	2
1.0 INSTALLATION	3
2.0 OPERATION	4
3.0 MAINTENANCE	5
DIMENSIONS AND WEIGHTS	6
REPLACEMENT ELEMENTS	7
WARRANTY	8

General Safety Information

1. Pressurized devices

WARNING

- Do not exceed maximum operating pressure indicated on serial number tag.
- Make certain filter is fully depressurized before servicing.

2. Breathing Air

- Air treated by this equipment may not be suitable for breathing without further purification. Refer to OSHA standard 1910.134 for breathing air requirements.

3. Flammable gases

WARNING

While the materials of construction are compatible with many flammable gases, the following application limitations must be considered:

- Housing materials are slightly porous. The product must be used in a well ventilated area in the absence of sparks or ignition sources. Do not use in Class 1, Division 1, Group D environments.
- The type of area - forced exhaust system used (i.e., high or low level) would be dependent on the gas involved.
- Each application (other than for air or inert gas) must be reviewed to minimize fire or explosion hazard.



COMPRESSED

AIR

FILTERS

Model Number Configuration

Corrosion Resistant Models

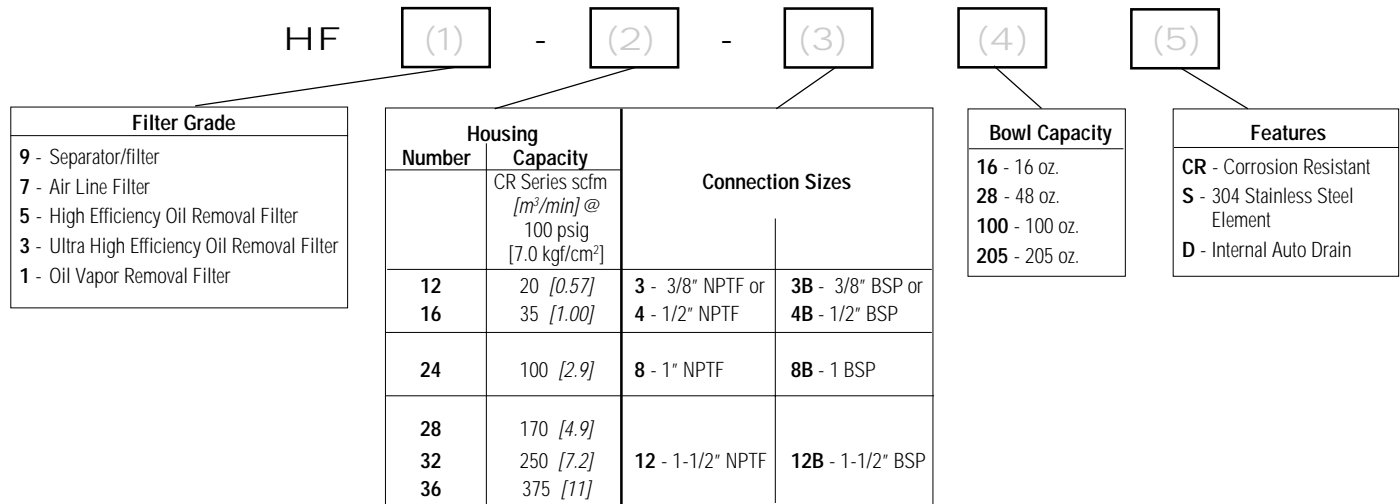

High Pressure Models

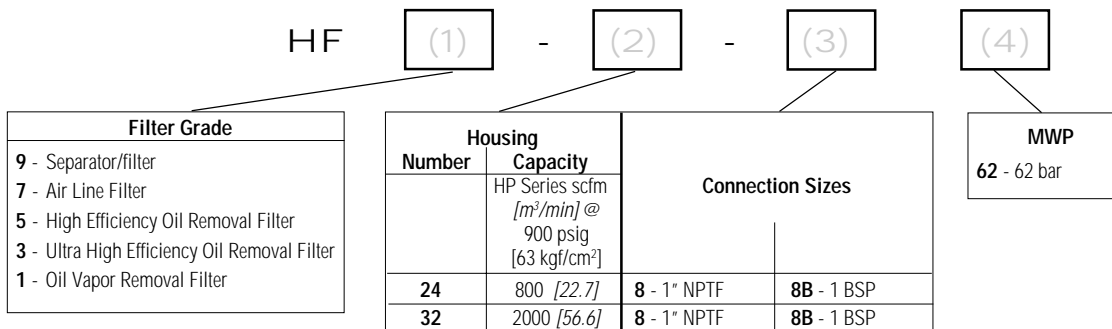

Grade Identification

Filter grade can be identified by the third digit of the model number. In addition, elements with a foam outer sleeve can be identified by color

Grade	Description	Type	Outer foam color
9	Separator/filter	Mechanical separator and 3 micron coalescer	none
7	General purpose air line filter	1 micron coalescer	none
5	High efficiency oil removal filter	High efficiency (99.99+%) coalescer	Red
3	Ultra high efficiency oil removal filter	Ultra high efficiency (99.999+%) coalescer	Blue
1	Oil vapor removal filter	Activated carbon adsorber	Green

1.0 Installation

A. Where Used/Air Quality After Filtration

Grade	Where used	Solid particle removal (maximum size in microns)	Liquid removal efficiency (at rated conditions)	Maximum inlet liquid loading ppm w/w	Remaining oil content ppm w/w
9	Separator - downstream of an aftercooler Point-of-use - where no aftercooler is installed upstream	3	99+% of water	25,000	5 aerosols
7	Prefilter - • Alone ahead of desiccant dryers if no oil is present • Ahead of Grade 3 Afterfilter - downstream of pressure-swing (heatless) desiccant dryers Point-of-use - where aftercooler is installed upstream	1	100% of water	2,000	1 aerosols
5	Prefilter - alone ahead of desiccant and membrane dryers if oil is present Afterfilter • Downstream of refrigerated dryer • Downstream of pressure-swing (heatless) desiccant dryers for finer solid particle removal	0.01	99.99+% of oil	1,000	0.01 aerosols
3	Prefilter - ahead of desiccant and membrane dryers if oil is present (use after Grade 7 to reduce liquid and solids load, prolong element life and ensure filtration efficiency) Afterfilter - downstream of refrigerated dryer	0.01	99.999+% of oil	100	0.001 aerosols
1	Use a Grade 7 or Grade 5 ahead of Grade 1 to remove any liquid present	0.01	Removes vapors only	No liquid should be present	0.003 vapor

B. Piping

1. Before installing, blow out pipe line to remove scale and other foreign matter.
2. This unit has DRYSEAL pipe threads; use pipe compound or tape sparingly to male threads only.
3. Mounting (Grades 9,7,5,3) - mount so that inlet and outlet connections are horizontal (filter bowl vertical) to ensure proper liquid drainage.
4. Flow Direction - install so that the air flow is in the direction of arrows on the filter head. Flow through the element is inside out.

C. Drain Provisions (Grades 9, 7, 5, 3)

1. Manual Drain - Collected liquids must be drained on a periodic basis. If equipped with a knurled fitting, turn the knurled fitting on the bottom of the bowl to your right (clockwise) to open and to your left (counterclockwise) to close.

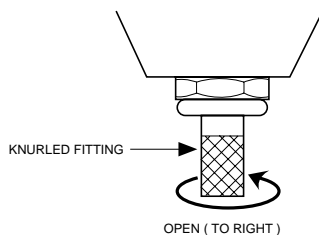

2. Auto Drain - Units with auto drains will automatically discharge any water and oil collected in the bowl.

- a. Filters with Internal Auto Drains - Internal Auto Drains may be manually drained by turning the knurled fitting to your right (clockwise) to open.
- b. Filters with External Auto Drains - Housings 28 and larger are provided with a 1/2" plug for installation of an external auto drain. To install an External Auto Drain, remove plug, attach nipple (and bushing if necessary) and Auto Drain.

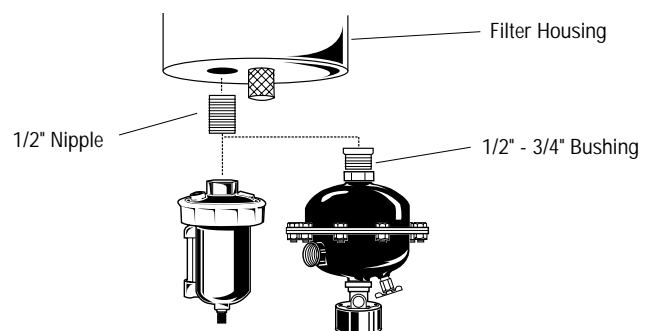

2.0 Operation

WARNING: Do not operate filter at pressures in excess of Maximum Working Pressure indicated on Serial Number Tag.

NOTE: Maximum Operating Temperature - 150°F, 66°C. Liquid filtration above 120°F, 49°C is not recommended since there is typically oil present in a vapor state which passes through the filter and condenses downstream.

NOTE: Grade 1 - If operated above 100°F, 38°C may experience less than 1000 hours of life because of greater oil vapor content.

A. Liquid Draining - Grades 9, 7, 5, 3

NOTE: Collected liquids must be removed to ensure proper operation.

NOTE: Depressurize slowly, to avoid filter element damage.

1. Manual Drain - Turn to your right (clockwise) to open and to your left (counterclockwise) to close.
2. Automatic Drain - Liquids will automatically discharge when sufficient accumulation occurs.
 - a. Internal Auto Drains - These drains may be manually drained by turning to your right (clockwise) to open and to your left (counterclockwise) to close.

NOTE: Manually drain internal auto drains daily to verify drain function.

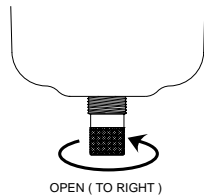

B. Operational Checkpoints

Grades 9,7,5,3

1. Check pressure drop across the filter
 - a. Pressure differential in excess of 10 psi (0.7 kgf/cm²) - indicates that the filter sleeve or element should be replaced.

NOTE: Element should be changed annually or when pressure drop reaches 10 psi (0.7 kgf/cm²), whichever occurs first.

NOTE: Pressure drop should never exceed 50 psi (3.5 kgf/cm²).

- b. Check for sudden reduction in pressure drop. This might indicate:
 - (1) Possible leak across element o-ring seal
 - (2) Leak through the element due to physical damage
2. Check flow, pressure, and temperature to make certain filter is being operated within design conditions.
3. Check to see that filter is installed level to insure proper drainage.

4. Check that manual drains are drained periodically or that automatic drains are functioning.

Grade 1

1. Check for an oily smell by opening the manual valve. If an oily smell exists, the following should be checked:
 - a. Filter element adsorption capacity exhausted
 - b. Leak across element o-ring seal
 - c. Leak through element due to physical damage
 - d. Presence of liquids because of lack of or failure of prefilters
 - e. Flow, pressure and temperatures outside design conditions
 - f. Presence of gaseous impurities which cannot be adsorbed

CAUTION: Methane, carbon monoxide, carbon dioxide and various inorganic gases cannot be removed by a Grade 1 filter.

C. Flow Capacity

Maximum air flow for the various filters is indicated in Table 1a for Corrosion Resistant Models and Table 1b for High Pressure Models. To determine maximum air flows at other inlet pressures, multiply flow from Table 1a or 1b by air flow correction factor from Table 2a for Corrosion Resistant Models and Table 2b for High Pressure Models, that corresponds to the operating pressure at the inlet of the filter.

NOTE: Filters should not be selected by pipe size. Select using flow rate and operating pressure only.

Table 1a - Corrosion Resistant Models - Maximum Flow @100 psig [7 kgf/cm²]

CR Models	scfm [m ³ /min]
12	20 [0.57]
16	35 [1.00]
24	100 [2.9]
28	170 [4.9]
32	250 [7.2]
36	375 [11]

Table 1b - High Pressure Model - Maximum Flow @900 psig [62 bar]

HP Model	scfm [m ³ /min]
24	800 [22.7]
32	2000 [56.6]

Air Flow Correction Factor

Table 2a - Corrosion Resistant Models

Minimum Inlet Pressure	psig	20	30	40	60	80	100	120	150	200	250	300
	kgf/cm ²	1.4	2.1	2.8	4.2	5.6	7.0	8.4	10.6	14.1	17.6	21.1
Correction Factor		0.30	0.39	0.48	0.65	0.82	1.00	1.17	1.43	1.87	2.31	2.74

Table 2b - High Pressure Models

Minimum Inlet Pressure	psig	400	500	600	700	800	900
	kgf/cm ²	28.1	35.2	42.2	49.2	56.3	63.3
Correction Factor		0.45	0.56	0.67	0.78	0.89	1.00

3.0 Maintenance

A. When to Replace Filter Element

NOTE: Grades 7,5,3,1 - complete element is replaced;
Grade 9 - unless separator core is damaged outer sleeve only is replaced.

1. Grades 9,7,5,3
 - a. Initial (dry) pressure drop: 1 psi (0.07 kgf/cm²) to 2 psi (0.14 kgf/cm²)
 - b. Operating pressure drop: As filter becomes liquid loaded (wetted), pressure drop will increase to 2 to 6 psi (0.14 to 0.42 kgf/cm²). Further pressure drop occurs as element loads with solid particles.

FOR MAXIMUM FILTRATION EFFICIENCY, REPLACE ELEMENT WHEN PRESSURE DROP REACHES 10 PSI (0.7 KGF/CM²) OR ANNUALLY, WHICHEVER OCCURS FIRST.

NOTE: Pressure drop may temporarily increase when flow is resumed after flow stoppage. Pressure drop should return to normal within one hour.

NOTE: Grades 5 and 3 - During normal operation bottom of foam sleeve will have a band of oil. Spotting above the band indicates that liquids are accumulating faster than they can be drained and that prefiltration is required.

2. Grade 1
 - a. Adsorption capacity - 1000 hours at rated capacity. Element life is exhausted when odor can be detected downstream of the filter.

B. Procedure for Filter Element Replacement

CAUTION: THIS FILTER IS A PRESSURE CONTAINING DEVICE. DEPRESSURIZE BEFORE SERVICING.

1. Isolate filter assembly from system by opening by-pass valve (if one is installed) and closing inlet and outlet valves.
2. Depressurize filter by slowly opening manual drain valve.
3. Disassemble filter housing
 - a. For High Pressure Model 24 - unscrew the collar holding the filter bowl to the head and remove the filter bowl and collar.
 - b. For Corrosion Resistant Models 12 thru 36 and High pressure Model 32 Remove the filter bowl, unscrewing it from the filter head by hand or strap wrench.
4. Clean filter bowl
5. Remove and replace complete element (all models) or sleeve only (Grade 9)
 - a. Removing and replacing complete element

- 1) Unscrew the old filter element and discard. Also discard the small o-ring that seals the filter to the filter assembly head.
- 2) Insert small replacement o-ring on top of replacement filter element and screw replacement element into filter assembly head.

b. Removing and replacing sleeve only (Grade 9)

- 1) Remove nut and bottom cap.
- 2) Slide disposable filter sleeve down over separator core.
- 3) If necessary, unscrew separator core from filter head and clean with soap and water.
- 4) Reassemble separator core to head. (Use new o-ring supplied with replacement sleeve).
- 5) Slide new filter sleeve over separator core.
- 6) Replace bottom cap and nut.

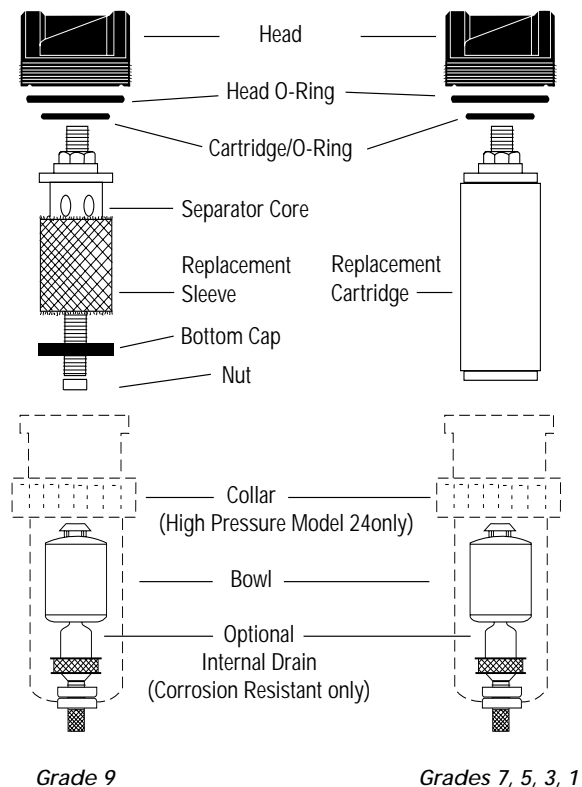

C. Internal Auto Drain Mechanism - (Corrosion Resistant Models only)

It is recommended that drain mechanism be replaced annually.

Dimensions and Weights

Models	In/Out Connections*	Bowl Type	Dimensions in. (mm)				Weights lbs (kg)
			A	B	C	D	
12	03 or 04 3/8" or 1/2"	16 16 oz. Metal	3-3/16 (81)	10 (254)	9-3/8 (238)	4 (102)	2-3/4 (1.24)
16	03 or 04 3/8" or 1/2"	16 16 oz. Metal	3-3/16 (81)	10 (254)	9-3/8 (238)	4 (102)	2-3/4 (1.24)
24	08 1"	48 48 oz. Metal	4 (102)	16 (406)	12-3/4 (324)	6 (152)	6 (2.7)
28, 32 (1)	12 1-1/2"	100 100 oz. Metal	5-1/8 (130)	25-5/8 (651)	22-1/8 (562)	14 (365)	19 (18.9)
32 (1), 36	12 1-1/2"	205 205 oz. Metal	5-1/8 (130)	32-7/16 (824)	28-15/16 (735)	16 (406)	21 (9.5)
32 HP	8 1"	100 100 oz. Metal	4-1/4 (108)	23-7/8 (605)	22-7/16 (569)	6-3/4 (172)	24.3 (11)

* NPT Female; B after connection size indicates BSP threads.

(1) Model 32 Corrosion Resistant, Grades 7, 5, 3, 1 are in 100 oz. bowl; Model 32 Corrosion Resistant for Grade 9 is in 205 oz. bowl.

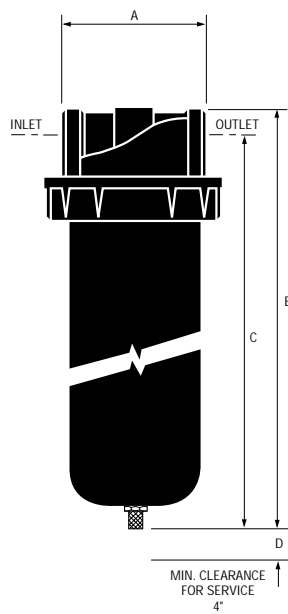

High Pressure Model
24

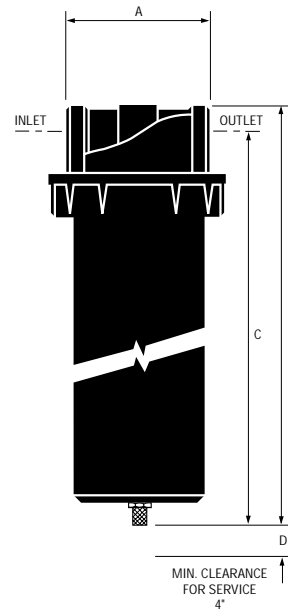

Corrosion Resistant Models
12, 16, 24, 28, 32, and 36

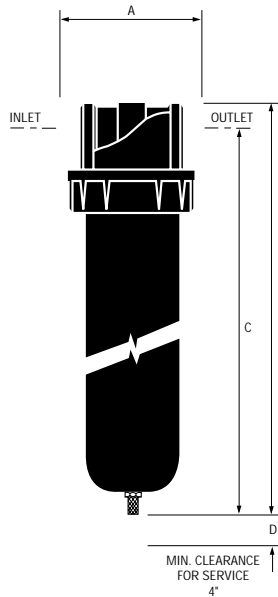

High Pressure Model
32

Replacement Elements

High Pressure

Model	Element*
HF9-24-8-62	E9-24-07**
HF7-24-8-62	E7-24-08
HF5-24-8-62	E5-24-08
HF3-24-8-62	E3-24-08
HF1-24-8-62	E1-24-08

*Add S to element number for 304SS elements (eg. E9-24S-07).

**Sleeve only: S9-24 or S9-24S for 304SS.

Model	Element*
HF9-32-8-62	E9-32-11**
HF7-32-8-62	E7-32-10
HF5-32-8-62	E5-32-10
HF3-32-8-62	E3-32-10
HF1-32-8-62	E1-32-10

*Add S to element number for 304SS elements

(eg. E9-32S-11).

Corrosion Resistant Housing, SS Element

Model	Sleeve	Element
HF9-12-3-16CRS	S9-12S	E9-12S-02
HF9-12-4-16CRS	S9-12S	E9-12S-02
HF9-16-3-16CRS	S9-16S	E9-16S-04
HF9-16-4-16CRS	S9-16S	E9-16S-04
HF9-24-8-48CRS	S9-20S	E9-20S-06
HF9-28-12-100CRS	S9-24S	E9-24S-09
HF9-32-12-205CRS	S9-32S	E9-32S-11
HF9-36-12-205CRS	S9-36S	E9-36S-12

Model	Element
HF3-12-3-16CRS	E3-16S-03
HF3-12-4-16CRS	E3-16S-03
HF3-16-3-16CRS	E3-20S-05
HF3-16-4-16CRS	E3-20S-05
HF3-24-8-48CRS	E3-24S-08
HF3-32-12-100CRS	E3-32S-10
HF3-36-12-205CRS	E3-36S-13

Model	Element
HF7-12-3-16CRS	E7-16S-03
HF7-12-4-16CRS	E7-16S-03
HF7-16-3-16CRS	E7-20S-05
HF7-16-4-16CRS	E7-20S-05
HF7-24-8-48CRS	E7-24S-08
HF7-32-12-100CRS	E7-32S-10
HF7-36-12-205CRS	E7-36S-13

Model	Element
HF1-12-3-16CRS	E1-16S-03
HF1-12-4-16CRS	E1-16S-03
HF1-16-3-16CRS	E1-20S-05
HF1-16-4-16CRS	E1-20S-05
HF1-24-8-48CRS	E1-24S-08
HF1-32-12-100CRS	E1-32S-10
HF1-36-12-205CRS	E1-36S-13

Model	Element
HF5-12-3-16CRS	E5-16S-03
HF5-12-4-16CRS	E5-16S-03
HF5-16-3-16CRS	E5-20S-05
HF5-16-4-16CRS	E5-20S-05
HF5-24-8-48CRS	E5-24S-08
HF5-32-12-100CRS	E5-32S-10
HF5-36-12-205CRS	E5-36S-13

WARRANTY

The manufacturer warrants the product manufactured by it, when properly installed, operated, applied, and maintained in accordance with procedures and recommendations outlined in manufacturer's instruction manuals, to be free from defects in material and workmanship for a period of one (1) year from date shipment to the buyer by the manufacturer or manufacturer's authorized distributor provided such defect is discovered and brought to the manufacturer's attention within the aforesaid warranty period.

The manufacturer will repair or replace any product or part determined to be defective by the manufacturer within the warranty period, provided such defect occurred in normal service and not as a result of misuse, abuse, neglect or accident. Normal maintenance items requiring routine replacement are not warranted. The warranty covers parts and labor for the warranty period. Repair or replacement shall be made at the factory or the installation site, at the sole option of the manufacturer. Any service performed on the product by anyone other than the manufacturer must first be authorized by the manufacturer.

Unauthorized service voids the warranty and any resulting charge or subsequent claim will not be paid.

Products repaired or replaced under warranty shall be warranted for the unexpired portion of the warranty applying to the original product.

The foregoing is the exclusive remedy of any buyer of the manufacturer's product. The maximum damages liability of the manufacturer is the original purchase price of the product or part.

THE FOREGOING WARRANTY IS EXCLUSIVE AND IN LIEU OF ALL OTHER WARRANTIES, WHETHER WRITTEN, ORAL, OR STATUTORY, AND IS EXPRESSED IN LIEU OF THE IMPLIED WARRANTY OF MERCHANTABILITY AND THE IMPLIED WARRANTY OF FITNESS FOR A PARTICULAR PURPOSE. THE MANUFACTURER SHALL NOT BE LIABLE FOR LOSS OR DAMAGE BY REASON OF STRICT LIABILITY IN TORT OR ITS NEGLIGENCE IN WHATEVER MANNER INCLUDING DESIGN, MANUFACTURE OR INSPECTION OF THE EQUIPMENT OR ITS FAILURE TO DISCOVER, REPORT, REPAIR, OR MODIFY LATENT DEFECTS INHERENT THEREIN.

THE MANUFACTURER, HIS REPRESENTATIVE OR DISTRIBUTOR SHALL NOT BE LIABLE FOR LOSS OF USE OF THE PRODUCT OR OTHER INCIDENTAL OR CONSEQUENTIAL COSTS, EXPENSES, OR DAMAGES INCURRED BY THE BUYER, WHETHER ARISING FROM BREACH OF WARRANTY, NEGLIGENCE OR STRICT LIABILITY IN TORT.

The manufacturer does not warrant any product, part, material, component, or accessory manufactured by others and sold or supplied in connection with the sale of manufacturer's products. 1/96

AUTHORIZATION FROM THE SERVICE DEPARTMENT IS NECESSARY BEFORE MATERIAL IS RETURNED TO THE FACTORY OR IN-WARRANTY REPAIRS ARE MADE.

SERVICE DEPARTMENT: (724) 746-1100



Division Of Hansen Inc.
Canonsburg, PA 15317-1700 U.S.A.
Tel 724-745-1555 Fax 724-745-6040
E-mail - service@hankisonintl.com