

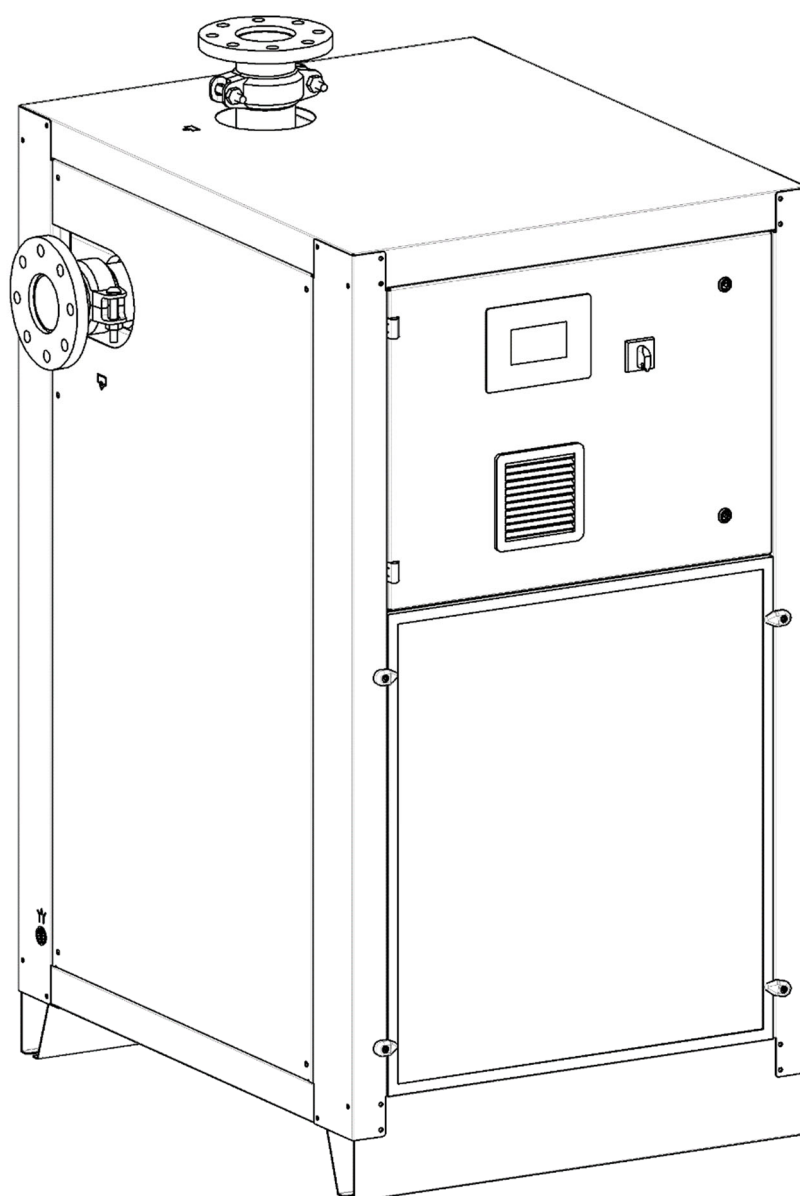

EN - english

Instructions for installation and operation
Compressed air refrigeration dryer
DRYPOINT® RA VSD 800-2500



Dear customer,

Thank you for deciding in favour of the DRYPOINT® RA VSD 800-2500 compressed-air refrigeration dryer. Please read these installation and operating instructions carefully before mounting and starting up the DRYPOINT® RA VSD 800-2500 and follow our directions. Perfect functioning of the DRYPOINT® RA VSD 800-2500 and thus reliable compressed-air drying can only be guaranteed when the provisions and notes stipulated here are strictly adhered to.

Contents

1	Name plate	5
2	Safety instructions	5
2.1	Safety pictograms in accordance with DIN 4844	6
2.2	Signal words in accordance with ANSI	8
2.3	Overview of the safety instructions	8
3	Proper use of the dryer	11
4	Exclusion from a field of application	11
5	Instructions for the use of pressure equipment according to PED directive 2014/68/EU	11
6	Transport	12
7	Storage	12
8	Installation	13
8.1	Place of installation	13
8.2	Installation layout	14
8.3	Correction factors	15
8.4	Connection to the compressed air system	16
8.4.1	Inlet / outlet flanged air connections (only RA VSD 800-1250)	16
8.5	Connection to the cooling water network (Water-Cooled)	17
8.6	Minimum cooling water requirements (referred to Tube & Shell condenser)	17
8.7	Electrical connections	18
8.8	Condensate drain	19
9	Start-up	19
9.1	Preliminary operation	19
9.2	First start-up	20
9.3	Start-up and shut down	21
10	Technical data	22
10.1	Technical data DRYPOINT RA VSD 800 – 2500 3/460/60	22
11	Technical description	23
11.1	Control panel	23
11.2	Operation	23
11.3	Flow diagram (Air-Cooled)	24
11.4	Flow diagram (Water-Cooled)	24
11.5	Refrigerating compressor	25
11.6	Condenser (Air-Cooled)	25
11.7	Condenser (Water-Cooled)	25
11.8	Condenser water regulating valve (Water-Cooled)	25
11.9	Filter dryer	26
11.10	Electronic Expansion Valve (EEV)	26
11.11	Alu-Dry module	26
11.12	Refrigerant pressure switches LPS – HPS	26
11.13	Compressor crankcase heater	26
11.14	Electrical panel fan	26
11.15	DMC55 electronic control unit	27
11.15.1	Starting the dryer ("ON" mode)	27
11.15.2	Stopping the dryer ("STANDBY" mode)	27
11.15.3	Condensation drain test	27
11.15.4	Chilling circuit process values	28
11.15.5	WARNING condition	29
11.16	ALARM condition	31
11.16.1	Alarm history	33
11.16.2	Installing and Removing the USB storage drive	34
11.16.3	Compressor and fan drive process values	34
11.16.4	Electronic expansion valve process values	35
11.16.5	Energy saving data and operating hours	36
11.16.6	Remote start/stop, remote reset of Warnings/Alarms	37
11.16.7	"Alarm" and "dryer running" signal contacts	37
11.16.8	4-20mA analogue output	37
11.16.9	RS485 MODBUS RTU communication port	38
11.16.10	Changing process user parameters	38
11.16.11	List of spare parts	40
11.16.12	System settings and weekly timer	41
11.17	Electronically level-controlled BEKOMAT condensate drain	42
12	Maintenance, troubleshooting, spare parts and dismantling	43
12.1	Checks and maintenance	43
12.2	Troubleshooting	44

12.3	Spare parts	54
12.4	Maintenance operation on the refrigeration circuit	55
12.5	Dismantling of the dryer	55
13	Attachments	56
	Exploded views – List of components	56
	Electric diagrams – List of components	56
13.1	Dryers dimensions	56
13.1.1	DRYPOINT® RA VSD 800-1250	57
13.1.2	DRYPOINT® RA VSD 1500-2500	57
13.2	Exploded views	57
13.2.1	DRYPOINT® RA VSD 800-1250 Air-Cooled	57
13.2.2	DRYPOINT® RA VSD 800-1250 Water-Cooled	57
13.2.3	DRYPOINT® RA VSD 1500-2500 Air-Cooled	57
13.2.4	DRYPOINT® RA VSD 1500-2500 Water-Cooled	57
13.3	Electric diagrams	57
13.3.1	DRYPOINT® RA VSD 800-1250	57
13.3.2	DRYPOINT® RA VSD 1500-1750	57
13.3.3	DRYPOINT® RA VSD 2000-2500	57

1 Name plate

The name plate is on the back of the dryer and comprises all primary data of the device. Always refer to this data when contacting the manufacturer or the sales department.

All guarantee claims will expire in the event that the name plate is modified or removed.

2 Safety instructions



Please check whether or not these instructions correspond to the device type.

Please adhere to all advice given in these operating instructions. They include essential information which must be observed during installation, operation and maintenance. Therefore, it must be ensured that these operating instructions are read by the fitter and the responsible operator / certified skilled personnel prior to installation, start-up and maintenance.

The operating instructions must be accessible at all times at the place of application of the DRYPOINT® RA VSD 800-2500 compressed-air refrigeration dryer.

In addition to these operating instructions, local and national regulations need to be observed, where required.

Ensure that operation of the DRYPOINT® RA VSD 800-2500 compressed-air refrigeration dryer only takes place within the permissible limit values indicated on the name plate. Any deviation from these limit values involves a risk for persons and for the material, and may result in malfunction or a breakdown.

After installing the device correctly and in accordance with the instructions in this manual, the dryer is ready to operate, further settings are not required. Operation is fully automatic and maintenance is limited to several examinations and cleaning measures which are described in the following chapters.

This manual must be available at all times for future reference and is a constituent part of the dryer.

If you have any questions regarding these installation and operating instructions, please contact BEKO TECHNOLOGIES.

2.1 Safety pictograms in accordance with DIN 4844



Observe operating instructions



General danger symbol



Supply voltage



Danger: component or system under pressure



Hot surfaces



Non-breathable air



Do not use water to extinguish the fire



Do not operate with open cover (housing)



Maintenance works or controlling measures must only be carried out by qualified personnel ¹



Do not smoke



Note



Connection point compressed-air inlet



Connection point compressed-air outlet



Connection point condensate drain



Connection point cooling-water inlet (water-cooled)



Connection point cooling-water outlet (water-cooled)

¹ Certified skilled personnel are persons who are authorised by the manufacturer, with experience and technical training, who are well-grounded in the respective provisions and laws and capable of carrying out the required works and of identifying and avoiding any risks during the machine transport, installation, operation and maintenance. Qualified and authorised operators are persons who are instructed by the manufacturer regarding the handling of the refrigeration system, with experience and technical training, and who are well-grounded in the respective provisions and laws.



Works can be carried out by the operator of the plant, provided that they are skilled accordingly¹.

NOTE: Text that contains important specifications to be considered – does not refer to safety precautions.



The device was carefully designed with particular attention paid to environmental protection:

- CFC-free refrigerants
- CFC-free insulation material
- Energy-saving design
- Limited acoustic emissions
- Dryer and packaging comprise reusable materials

This symbol advises the user to observe the environmental aspects and comply with the recommendations connected with this symbol.

2.2 Signal words in accordance with ANSI

Danger!	Imminent hazard Consequences of non-observance: serious injury or death
Warning!	Potential hazard Consequences of non-observance: possible serious injury or death
Caution!	Imminent hazard Consequences of non-observance: possible injury or property damage
Notice!	Potential hazard Consequences of non-observance: possible injury or property damage
Important!	Additional advice, info, hints Consequences of non-observance: disadvantages during operation and maintenance, no danger

2.3 Overview of the safety instructions



Certified skilled personnel

Installation works must exclusively be carried out by authorised and qualified skilled personnel. Prior to undertaking any measures on the compressed-air refrigeration dryer, the certified skilled personnel shall read up on the device by carefully studying the operating instructions. The operator is responsible for the adherence to these provisions. The respective directives in force apply to the qualification and expertise of the certified skilled personnel.

For safe operation, the device must only be installed and operated in accordance with the indications in the operating instructions. In addition, the national and operational statutory provisions and safety regulations, as well as the accident prevention regulations required for the respective case of application, need to be observed during employment. This applies accordingly when accessories are used.



Danger!

Compressed air!

Risk of serious injury or death through contact with quickly or suddenly escaping compressed air or through bursting and/or unsecured plant components.

Compressed air is a highly dangerous energy source.

Never work on the dryer when the system is under pressure.

Never direct the compressed-air outlet or condensate drain hoses at persons.

The user is responsible for the proper installation of the dryer. Non-observance of the instructions in the "Installation" chapter leads to the expiration of the guarantee. Improper installation may result in dangerous situations for the personnel and/or the device.



Danger!

Supply voltage!

Contact with non-insulated parts carrying supply voltage involves the risk of an electric shock resulting in injuries and death.

Only qualified and skilled personnel are authorised to run electrically-operated devices. Prior to undertaking maintenance measures at the device, the following requirements must be met:

Make sure that the power supply is switched off and that the device is off and marked for maintenance measures. Please also ensure that the power supply cannot be re-established during the works.



Prior to carrying out maintenance works at the dryer, switch it off main switch (control panel pos.1) and wait for at least 30 minutes.



Caution!

Refrigerant!

The compressed-air refrigeration dryer uses HFC-containing refrigerants as a coolant.

Please observe the corresponding paragraph entitled "Maintenance works at the refrigeration cycle".

**Warning!****Refrigerant leak!**

A refrigerant leak involves the danger of serious injury and damage to the environment.



The compressed-air refrigeration dryer contains fluorinated greenhouse gas/refrigerant.

Installation, repair and maintenance works at the refrigeration system must only be carried out by certified skilled personnel (specialists). A certification in accordance with EC regulation 303/2008 must be available.

The requirements of the EC 842/2006 directive must be met under all circumstances.



Please refer to the indications on the name plate as regards the type and amount of refrigerant.

Comply with the following protective measures and rules of conduct:



1. **Storage:** Keep the container tightly closed. Keep it in a cool and dry place. Protect it against heat and direct sunlight. Keep it away from ignition sources.

2. **Handling:** Take measures against electrostatic charging. Ensure good ventilation/suction at the workplace. Check fittings, connections and ducts for tightness. Do not inhale the gas. Avoid contact with the eyes or the skin.



3. Prior to carrying out works on refrigerant-carrying parts, remove the refrigerant to such an extent that safe working is possible.

4. Do not eat, drink or smoke during work. Keep out of the reach of children.

5. **Breathing protection:** ambient-air-independent respirator (at high concentrations).

6. **Eye protection:** sealing goggles.

7. **Hand protection:** protective gloves (e.g. made of leather).

8. **Personal protection:** protective clothing.

9. **Skin protection:** use protective cream.

In addition, the safety data sheet for the refrigerant needs to be observed!

**Caution!****Hot surfaces!**

During operation, several components can reach surface temperatures of more than +60°C. There is the risk of burns.

All components concerned are installed inside of the closed housing. The housing must only be opened by certified skilled personnel².

**Caution!****Improper use!**

The device is intended for the separation of water in compressed air. The dried compressed air cannot be used for breathing-air purposes and is not suitable for the direct contact with food.

This dryer is not suitable for the treatment of contaminated air or of air containing solids.

²Certified skilled personnel are persons who are authorised by the manufacturer, with experience and technical training, who are well-grounded in the respective provisions and laws and capable of carrying out the required works and of identifying and avoiding any risks during the machine transport, installation, operation and maintenance. Qualified and authorised operators are persons who are instructed by the manufacturer regarding the handling of the refrigeration system, with experience and technical training, and who are well-grounded in the respective provisions and laws.



Note!

Contaminated intake air!

In normal condition (comply with ISO 8573.1 class 2.-3) we recommend the installation of C-Filters (e. g. CLEARPOINT S040CWT) upstream to the dryer.

In case the intake air is strongly contaminated (ISO 8573.1 class 5.-4 or poorer quality), we recommend the installation of a fine filter (e.g. CLEARPOINT S040FWT) in order to guarantee an optimal thermal transfer in the heat exchanger. Strongly contaminated compressed air leads to the concentration of oil, creating an oil layer that interrupts the thermal transfer and could clog the heat exchanger / filter.



Caution!

Heating-up through fire!

In the event of a heating-up through fire, the containers and pipes of the refrigerant system can burst.



In this case, please proceed as follows:

Switch off the refrigeration plant.

Switch off the mechanical ventilation of the machinery compartment.

Use ambient-air-independent respirators.

Containers and plants which are filled with refrigerant can burst violently in the event of fire.

The refrigerants themselves are incombustible, but they are degraded to very toxic products at high temperatures.

Remove the container/plant from the fire zone, as there is the risk of bursting!

Cool down containers and bottles via a directed water jet from a safe position.

In the event of fire, please use an approved fire extinguisher. Water is not a suitable agent to extinguish an electrical fire.

This must only be carried out by persons who are trained and informed about the hazards emanating from the product.



Caution!

Unauthorised intervention!

Unauthorised interventions may endanger persons and plants and lead to malfunction.

Unauthorised interventions, modification and abuse of the pressure devices are prohibited.

The removal of sealings and leadings at safety devices is prohibited.

Operators of the devices must observe the local and national pressure equipment regulations in the country of installation.



Note!

Ambient conditions!

In the event that the dryer is not installed under suitable ambient conditions, the ability of the device to condense refrigerant gas is impaired. This can result in a higher load of the refrigerating compressor, and in a loss of efficiency and performance of the dryer.

This in turn leads to overheated condenser fan motors, to malfunction of electric components and to a breakdown of the dryer. Failures of this type will affect warranty considerations.

Do not install the dryer in an environment in which chemicals with a corrosive effect, explosive gases, toxic gases, evaporation heat, high ambient temperatures or extreme dust and dirt can be found.

3 Proper use of the dryer

This dryer has been designed, manufactured and tested for the purpose of separating the humidity normally contained in compressed air. Any other use has to be considered improper.

The Manufacturer will not be responsible for any problem arising from improper use; the user will bear responsibility for any resulting damage.

Moreover, the correct use requires the adherence to the installation instructions, specifically:

- Voltage and frequency of the main power.
- Pressure, temperature and flow-rate of the inlet air.
- Pressure, temperature and cooling water capacity (Water-Cooled).
- Ambient temperature.

This dryer is supplied tested and fully assembled. The only operation left to the user is the connection to the plant in compliance with the instructions given in the following chapters.

4 Exclusion from a field of application



Note!
Improper use!



The device is intended for the separation of water in compressed air. The dried compressed air cannot be used for breathing-air purposes and is not suitable for the direct contact with food.

This dryer is not suitable for the treatment of contaminated air or of air containing solids.

5 Instructions for the use of pressure equipment according to PED directive 2014/68/EU

The DRYPOINT® RA VSD 800-2500 compressed-air refrigeration dryer contains pressure equipment in the sense of the 2014/68/EU Pressure Equipment Directive. Therefore, the entire plant needs to be registered with the supervisory authority if required in accordance with the local regulations.

For the examination prior to the start-up and for periodic inspections, the national regulations need to be observed, such as the industrial safety regulation in the United States of America. In countries outside the US, the respective regulations in force there need to be adhered to.

The proper use of pressure devices is the basic requirement for safe operation. As regards pressure devices, the following points need to be observed:

- The DRYPOINT® RA VSD 800-2500 compressed-air refrigeration dryer must only be employed within the pressure and temperature range limits indicated by the manufacturer on the name plate.
- No welding must be carried out on the pressure parts.
- The DRYPOINT® RA VSD 800-2500 compressed-air refrigeration dryer must neither be installed in insufficiently ventilated rooms nor near heat sources or inflammable substances.
- To avoid fractures resulting from material fatigue, the refrigeration dryer should not be exposed to vibrations during operation.
- The maximum operating pressure indicated by the manufacturer on the name plate must not be exceeded. It is the installer's responsibility to install the appropriate safety and control devices. Prior to the start-up of the DRYPOINT® RA VSD 800-2500 compressed-air refrigeration dryer, the connected pressure generator (compressor etc.) must be set to the max. permissible operating pressure. The integrated safeguard needs to be checked by an approved inspection agency.
- The documents related to the DRYPOINT® RA VSD 800-2500 compressed-air refrigeration dryer (manual, operating instructions, manufacturer's declaration etc.) must be kept safe for future reference.
- No objects whatsoever must be installed at or placed on the DRYPOINT® RA VSD 800-2500 compressed-air refrigeration dryer and the connecting lines.
- Installation of the DRYPOINT® RA VSD 800-2500 compressed-air refrigeration dryer in frost-free places only.
- Operation of the DRYPOINT® RA VSD 800-2500 compressed-air refrigeration dryer is only permissible with fully closed and intact housing and cover panels. Operation of the DRYPOINT® RA VSD 800-2500 compressed-air refrigeration dryer with damaged housing/cover panels is prohibited.

6 Transport

Check the packaging for visible loss or damage. If no visible damage can be ascertained, place the unit in close proximity to the place of installation and unpack the device.

During this procedure, the dryer must always remain in an upright position. The components may be damaged when the unit is tilted or turned upside down.

Store the device in a dry environment and do not expose it to extreme weather conditions.

Handle with care. Strong shocks can cause irreparable damage.

7 Storage

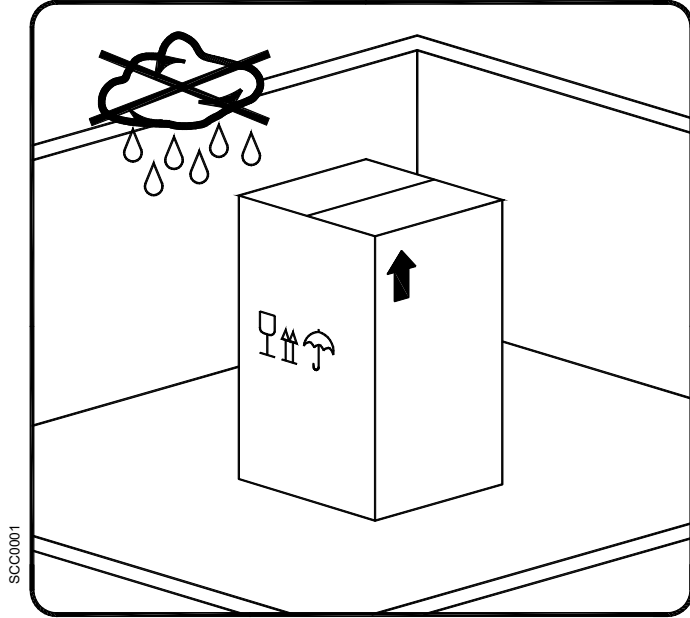

Keep the device away from extreme weather conditions even when packaged.

Keep the dryer in an upright position, also while it is stored. Tilting the device or turning it upside down can cause irreparable damage to some components.

When the dryer is not in use, it can be stored in its packaging in a dust-free and protected place at a temperature of +34°F (+1°C) ... +122°F (+50°C) and at a specific humidity of max. 90%. If the storage period exceeds 12 months, you should contact the manufacturer.

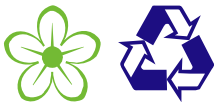

The packaging materials are recyclable. Dispose of material in compliance with the rules and regulations in force in the destination country.

8 Installation

8.1 Place of installation

**Note!****Ambient conditions!**

In the event that the dryer is not installed under suitable ambient conditions, the ability of the device to condense refrigerant gas is impaired. This can result in a higher load of the refrigerating compressor, and in a loss of efficiency and performance of the dryer.

This in turn leads to overheated condenser fan motors, to malfunction of electric components and to a breakdown of the dryer. Failures of this type will affect warranty considerations.

Do not install the dryer in an environment in which chemicals with a corrosive effect, explosive gases, toxic gases, evaporation heat, high ambient temperatures or extreme dust and dirt can be found.

Minimum installation requirements:

- Choose an area which is clean and dry, free from dust and protected against atmospheric disturbances.
- The load-bearing zone must be even, horizontal and able to bear the weight of the dryer.
- Minimum ambient temperature +34°F (+1°C).
- Maximum ambient temperature +113°F (+45°C).
- Ensure a proper cooling air replacement.
- Allow a sufficient clearance on each side of the dryer for proper ventilation and to facilitate maintenance operations. The dryer does not require attachment to the floor surface.

**Do not obstruct the ventilation grille (not even partially).**

Prevent any recirculation of the outgoing cooling air.

Protect the dryer against draughts.

8.2 Installation layout

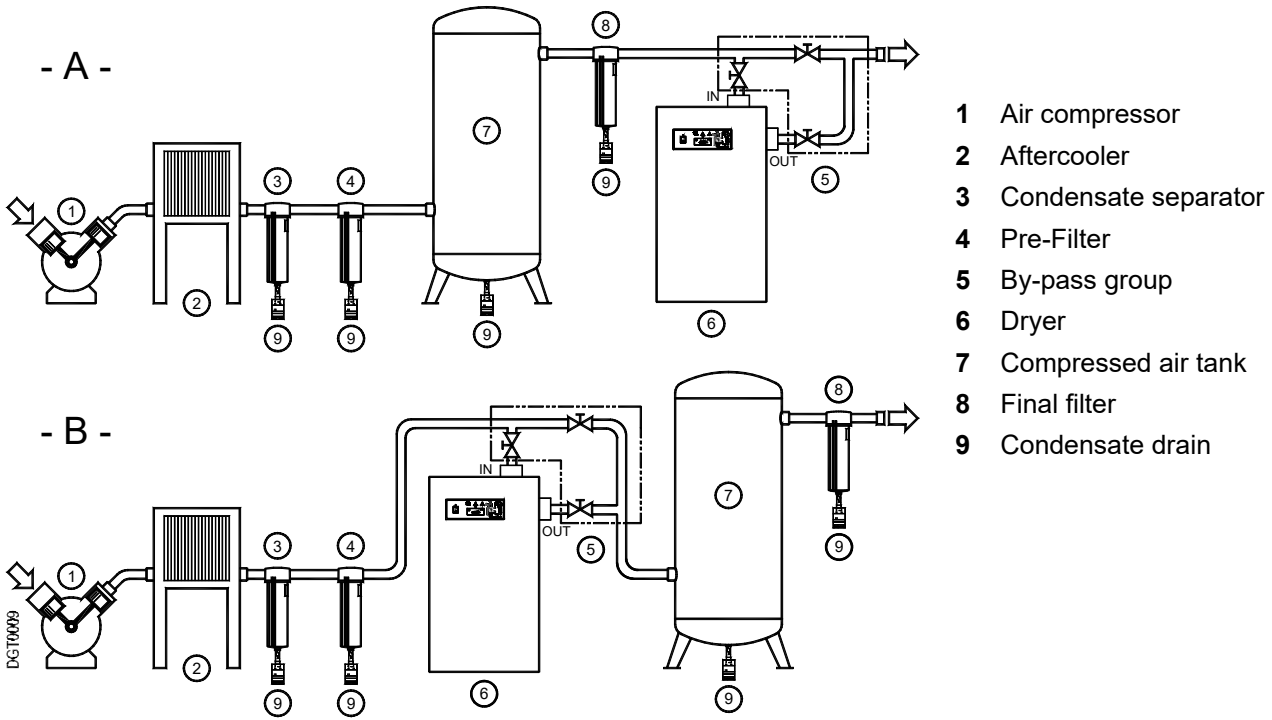

Dryer's compressor and fan (air cooled) speed are adjusted to adapt power consumption to the dryer load. Although system is quite reactive, it cannot adapt its setting immediately to sudden load variation leading to dewpoint spikes/fluctuations.

To avoid this behaviour it is recommended to install the dryer in systems where load variations happens but are damped. Compressed air receivers can be used as dampers: installed before the dryer if compressors capacity varies suddenly and frequently, after the dryer if the air consumption variation is very wide, frequent and sudden or both to have the best load variation dampness.

Compressed air tanks can be installed as capacity dampers: installed before the dryer (Type A) if the compressor capacity varies suddenly and often, after the dryer (Type B) if the change in air consumption is very large, frequent and sudden or both to have the improved dampening of the flow variation.



Do not obstruct the ventilation grille (not even partially).

Prevent any recirculation of the outgoing cooling air.
Protect the dryer against draughts.



Note!

Contaminated intake air!

In normal condition (comply with ISO 8573.1 class 2.-3) we recommend the installation of C-Filters (e. g. CLEARPOINT S040CWT) upstream to the dryer.

In case the intake air is strongly contaminated (ISO 8573.1 class 5.-4 or poorer quality), we recommend the installation of a fine filter (e.g. CLEARPOINT S040FWT) in order to guarantee an optimal thermal transfer in the heat exchanger. Strongly contaminated compressed air leads to the concentration of oil, creating an oil layer that interrupts the thermal transfer and could clog the heat exchanger / filter.

8.3 Correction factors

Correction factor for operating pressure modifications:									
Inlet air pressure	psig	60	80	100	120	140	160	180	203
	barg	4	5.5	7	8	10	11	12	14
Factor (F1)		0.79	0.91	1.00	1.07	1.13	1.18	1.23	1.27

Correction factor for ambient temperature modifications (Air-Cooled):									
Ambient temperature	°F	≤ 80	90	95	100	105	110	115	
	°C	≤ 27	32	35	38	40	43	45	
Factor (F2)		1.11	1.09	1.06	1.00	0.94	0.87	0.78	

Correction factor for inlet air temperature modifications:									
Air temperature	°F	≤ 90	100	110	122	130	140	150	158
	°C	≤ 32	38	43	50	55	60	65	70
Factor (F3)		1.16	1.00	0.82	0.68	0.61	0.52	0.45	0.40

Correction factor for DewPoint modifications:									
DewPoint	°F	38	41	45	50				
	°C	3	5	7	10				
Factor (F4)		1.00	1.08	1.20	1.36				

Calculation of the actual air throughput:

Actual air throughput = air throughput acc. to planning x factor (F1) x factor (F2) x factor (F3) x factor (F4)

Example:
 The **DRYPOINT RA VSD 800** has a planned nominal capacity of 800 scfm (1358 m³/h). The highest achievable air mass under the following operating conditions is:

- Air inlet pressure = 120 psig (8 barg) ⇒ Factor (F1) = 1.07
- Ambient temperature = 115°F (45°C) ⇒ Factor (F2) = 0.78
- Air inlet temperature = 122°F (50°C) ⇒ Factor (F3) = 0.68
- Pressure dew point = 50°F (10°C) ⇒ Factor (F4) = 1.36

Every function parameter corresponds to a numerical factor which, multiplied by the planned nominal capacity, determines the following:

Actual air throughput = 800 x 1.07 x 0.78 x 0.68 x 1.36 = 617 scfm (1048 m³/h)

617 scfm (1048 m³/h) is the maximum air mass of the dryer under the aforementioned operating conditions.

Selection of the best suitable model in accordance with the operating conditions:

Air throughput acc. to planning = $\frac{\text{Required air throughput}}{\text{factor (F1) x factor (F2) x factor (F3) x factor (F4)}}$

Example:
 The following operating parameters are known:

- Required air mass = 750 scfm (1274 m³/h)
- Air inlet pressure = 120 psig (8 barg) ⇒ Factor (F1) = 1.07
- Ambient temperature = 115°F (45°C) ⇒ Factor (F2) = 0.78
- Air inlet temperature = 122°F (50°C) ⇒ Factor (F3) = 0.68
- Pressure dew point = 50°F (10°C) ⇒ Factor (F4) = 1.36

To find out the correct dryer version, the required air mass must be divided by the correction factors of the parameters indicated above:

Air throughput acc. to planning = $\frac{750}{1.07 \times 0.78 \times 0.68 \times 1.36} = 972 \text{ scfm (1652 m³/h)}$

The suitable model for these requirements is **DRYPOINT RA VSD 1000** (with a specif. nominal capacity of 1000 scfm [1698 m³/h]).

8.4 Connection to the compressed air system



Danger!
Compressed air!

All works must only be carried out by qualified skilled personnel.

Never work on compressed-air systems which are under pressure.

The operator or the user must ensure that the dryer is never operated with a pressure exceeding the maximum pressure value indicated on the name plate. Exceeding the maximum operating pressure can be dangerous for the operator but also for the device.

The air temperature and the air flow at the inlet of the dryer must lie within the limit values indicated on the name plate. The connecting lines must be free from dust, iron rust, shards and other contaminations and correspond to the flow rate of the dryer. Should air with a very high temperature be treated, the installation of an aftercooler may be necessary. For the implementation of maintenance works, the installation of a bypass system is recommended.

The dryer was designed in such a manner that vibrations that may occur during operation are limited. Therefore, it is advisable to employ connecting lines (flexible hoses, vibration-inhibiting fittings etc.) which protect the dryer against possible vibrations in the pipework.

Note!

Contaminated intake air!



In normal condition (comply with ISO 8573.1 class 2-3) we recommend the installation of C-Filters (e. g. CLEARPOINT S040CWT) upstream to the dryer.

In case the intake air is strongly contaminated (ISO 8573.1 class 5-4 or poorer quality), we recommend the installation of a fine filter (e.g. CLEARPOINT S040FWT) in order to guarantee an optimal thermal transfer in the heat exchanger. Strongly contaminated compressed air leads to the concentration of oil, creating an oil layer that interrupts the thermal transfer and could clog the heat exchanger / filter.

8.4.1 Inlet / outlet flanged air connections (only RA VSD 800-1250)

Inlet / outlet flanged air connections and clamp joints are located inside the box under the dryer (see Fig.1).



Assembly flange (B) and clamp joint (A) as shown in Fig.2

Pay particular attention in not damaging the gasket of clamp joint (A).

Fully tighten the two bolts of clamp joint (see Fig.3)

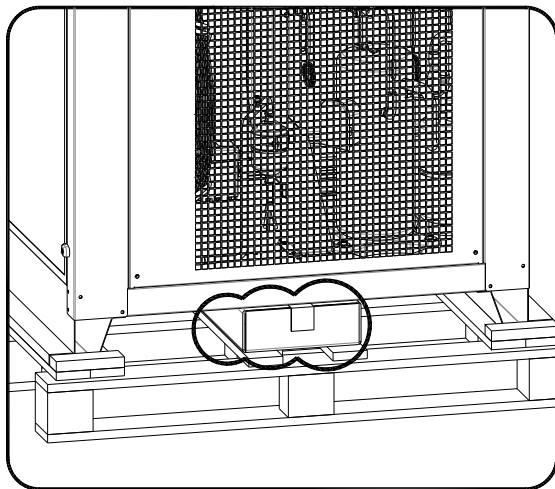

Fig.1

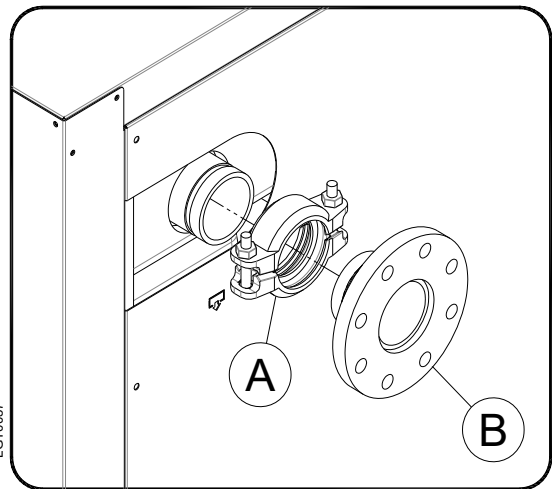

Fig.2

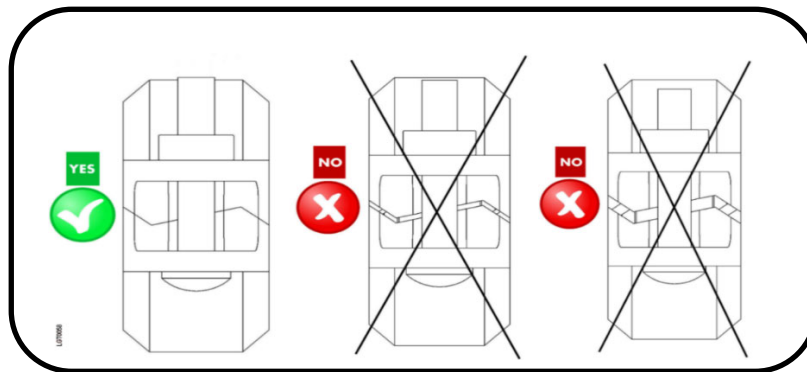

Fig.3

8.5 Connection to the cooling water network (Water-Cooled)



DANGER!

Compressed air and unqualified personnel!

All works must only be carried out by qualified skilled personnel.

Never work on compressed-air systems which are under pressure.

The user must ensure that the dryer is never operated with a pressure exceeding the nominal values.

Possible overpressure can be dangerous for the operator but also for the device.



The temperature and the amount of cooling water need to correspond to the limit values indicated on the name plate. The cross-section of the connecting lines, which should preferably be flexible, must be free from dust, iron rust, shards and other contaminations. We recommend employing connecting lines (flexible hoses, vibration-inhibiting fittings etc.) which protect the dryer against possible vibrations in the pipework.



Note!

Contaminated intake water!

In the event that the intake water is strongly contaminated we recommend the additional installation of a prefilter (500 micron), to avoid clogging of the heat exchanger.

8.6 Minimum cooling water requirements (referred to Tube & Shell condenser)

Temperature	+15°C...+30°C (+59°F...+86°F) *1
Pressure	3...10 barg (43.5...145 psig) *2
Delivery pressure	> 3 bar (43.5 psi) *2 *3
PH	7.5...9.0
Total hardness	6.0...15 °dH
Conductivity	10...1000 µS/cm
Sulphates (SO ₄ ²⁻)	< 100 mg/l or ppm
Hydrogen carbonate / Sulphates (HCO ₃ / SO ₄ ²⁻)	> 1.0 mg/l or ppm
Ammonia (NH ₃)	< 0.5 mg/l or ppm
Manganous ion (Mn ²⁺)	< 0.05 mg/l or ppm
Chlorides (Cl ⁻)	< 50 mg/l or ppm
Free chlorine (Cl ₂)	< 0.5 mg/l or ppm
Oxygen content	< 0.1 mg/l or ppm
Carbon dioxide (CO ₂)	< 50 mg/l or ppm
Hydrogen sulphide (H ₂ S)	< 0.05 mg/l or ppm
Phosphate (PO ₄ ³⁻)	< 2 mg/l or ppm
Ferric ion (Fe ³⁺)	< 0.5 mg/l or ppm

*1 Other temperatures upon request – check the data on the name plate.

*2 Other pressures upon request – check the data on the name plate.

*3 Pressure difference at the water connection of the dryer at maximum water flow. Other prevalences upon request.



CAUTION!

During the piping of the dryer, the inlet and outlet connections need to be supported as is shown in the illustration.

Non-observance will cause damage.

8.7 Electrical connections



Danger!

Supply voltage!

The connection to the electric mains should only be carried out by qualified skilled personnel and must correspond to the legal provisions in force in your region.

Before connecting the unit to the electrical supply, verify the data nameplate for the proper electrical information. Voltage tolerance is +/- 10%.

The installer is responsible for supplying and installing the power cable. Be sure to provide the proper fuses or breakers based on the data information located on the nameplate.

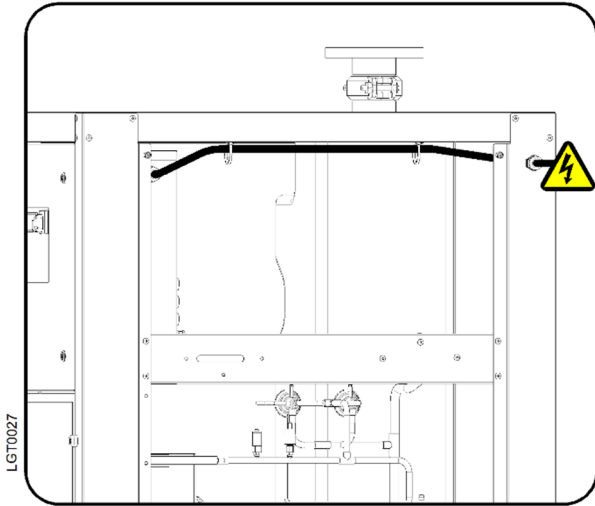

RA VSD 800-1250

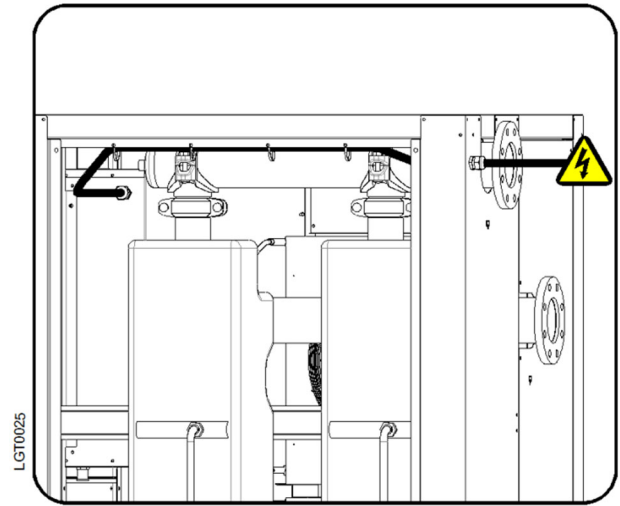

RA VSD 1500-2500

A residual-current device (RCD) with $I_{\Delta n} = 0.3A$ Class B is suggested. The cross section of the power supply cables must comply with the consumption of the dryer, while keeping into account also the ambient temperature, the conditions of the mains installation, the length of the cables, and the requirements enforced by the local Power Provider.

Compressor and fan(s) proper rotation direction are managed automatically by the drivers. It is not necessary to observe the phases sequence when connecting the power cable to the main switch.

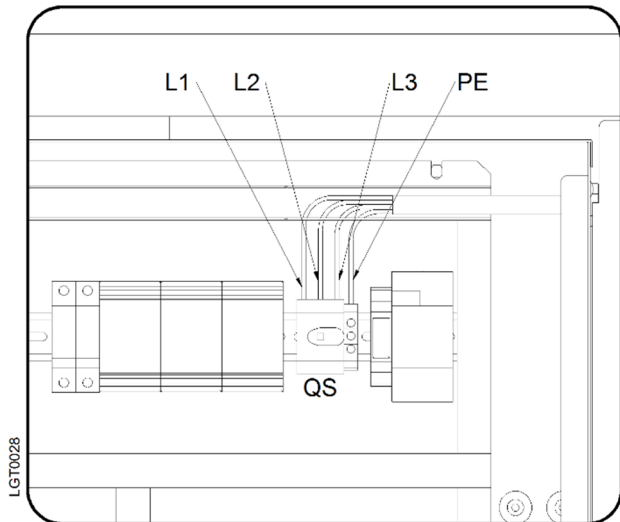

Danger!

Supply voltage and missing earth connection!

Important: ensure that the plant is connected to earth.

Do not use plug adapters at the power plug.

Possible replacement of the power plug must only be carried out by a qualified electrician.



Note!

This dryer is not suitable for employment on IT-systems.

This dryer is not suitable for employment on grounded-delta systems

8.8 Condensate drain



Danger!

Compressed air and condensate under pressure!

The condensate is discharged at system pressure.

The drain pipe needs to be secured.

Never direct the condensate drain pipe at persons.



The dryer comes already fitted with an electronic condensate drainer. Connect and properly fasten the condensate drain to a collecting plant or container. The drain cannot be connected to pressurized systems.



Do not discharge the condensate into the environment.

The condensate accumulating in the dryer contains oil particles which were released into the air by the compressor.

Dispose of the condensate in accordance with the local provisions.

It is advisable to install a water-oil separator, to which the total amount of condensate from the compressors, dryers, tanks, filters etc. is supplied.

We recommend ÖWAMAT oil-water separators for dispersed compressor condensate and BEKOSPLIT emulsion-splitting plants for emulsified condensate.

9 Start-up

9.1 Preliminary operation



Note!

Exceeding of the operating parameters!

Ensure that the operating parameters comply with the nominal values indicated on the name plate of the dryer (voltage, frequency, air pressure, air temperature, ambient temperature etc.).

Prior to delivery, this dryer was thoroughly tested, packed and checked. Please verify the soundness of the dryer during the initial start-up and check the perfect functioning during the first operating hours.

The initial start-up must be carried out by qualified personnel.



During the installation and operation of this device, all national regulations regarding electronics and any other federal and state ordinances, as well as local provisions, need to be adhered to.



The operator and the user must ensure that the dryer is not operated without panels.



Note!



The number of starts/stops by pressing the  button must be limited to six per hour. Irreparable damage can be caused by starting up the device too often.



The method below should be applied during the first start-up, after longer downtimes or subsequent to maintenance works.

The start-up must be carried out by certified skilled personnel.

Processing sequence (observe Section 11.1 "Control panel")

- Ensure that all steps of the "Installation" chapter have been carried out.
- Ensure that the connection to the compressed-air system is in accordance with the provisions and that the lines are fixed and supported properly.
- Ensure that the condensate drain pipe is fixed in accordance with the provisions and that it is connected with a collection system or a container.
- Ensure that the bypass system (if installed) is open and that the dryer is isolated.
- Ensure that the manual valve of the condensate outlet is open.
- Remove any packaging material and other items which may block the space around the dryer.
- Switch on the main switch.
- Switch on the main switch on the control panel (pos. 1).
- Wait about 45 seconds the initialization of the electronic controller DMC55.
- Select the desired language and the current date and time
- **Wait at least two hours before starting the dryer (the crankcase heater of the compressor needs to heat up the compressor oil).**
- Keep pressed the button  at least 3 seconds, the dryer starts and the display shows .
- If the temperature shown on the display is sufficiently high, verify that the refrigerating compressor starts within a few minutes. **NOTE!** – With low temperatures, the refrigerating compressor will remain OFF.
- Ensure that the cooling-water flow and the temperature are in accordance with the provisions (water-cooled).
- Ensure the effective operation of the fan, watching its speed percentage on the display (air-cooled).
- Wait until the dryer stabilises at the preset value.
- Slowly open the air inlet valve.
- Slowly open the air outlet valve.
- Slowly close the central bypass valve of the system (if installed).
- Check the pipes for air leakage.
- Ensure that the drain discharges at regular intervals – wait for the first interventions.



Note!

A dew point between 0°C and +10°C (32°F and 50°F) displayed on the electronic controller is considered to be correct according to the possible operating conditions (flow rate, air inlet temperature, ambient temperature etc.).

The electronic controller DMC55 adjusts compressor and fan(s) speed according to thermal load applied to the dryer. At very low or no load conditions, compressor is switched ON and OFF by the DMC55 to keep the temperature of the heat exchanger cold, allowing a consistent additional energy saving. The dryer needs to be switched on during the entire compressed-air usage time, even if the compressed-air compressor works periodically



Note!

Compressor and fan(s) proper rotation direction are managed automatically by the inverters. It is not necessary to observe the phases sequence when connecting the power cable to the main switch.



9.3 Start-up and shut down



During short-term shut down (max. two to three days), it is advisable to leave the dryer and the control panel connected to the supply current circuit. Otherwise, it would be necessary at a restart of the dryer to wait two hours, until the oil in the compressor has reached the specified operating temperature.





Start-up (see Section 11.1 "Control panel")

- Make sure that the condenser is clean (air-cooled).
- Make sure that the fan filter of electrical panel is clean.
- Ensure that the cooling-water flow and the temperature are in accordance with the provisions (water-cooled).
- The display of electronic controller shows 
- Keep pressed the button  at least 3 seconds, the dryer starts and the display shows .
- If the temperature shown on the display is sufficiently high, verify that the refrigerating compressor starts within a few minutes. **NOTE!** – With low temperatures, the refrigerating compressor will remain OFF.
- Wait for several minutes and then check whether or not the dew point temperature which is indicated on the display of the DMC55 electronics is correct and whether or not the condensate is discharged at regular intervals.
- Switch on the air compressor.



Shut down (see Section 11.1 "Control panel")

- Check that the DewPoint temperature displayed on electronic controller is within range.
- Shut down the air compressor.
- Keep pressed the button  at least 3 seconds, the dryer stops and the display shows .



Dryer remote control ON/OFF

- See instructions on section 11.15.11



Note!

A dew point between +32°F (0°C) and +50°F (+10°C) displayed on the electronic controller is considered to be correct according to the possible operating conditions (flow rate, air inlet temperature, ambient temperature etc.).

The electronic controller DMC55 adjusts compressor and fan(s) speed according to thermal load applied to the dryer. At very low or no load conditions, compressor is switched ON and OFF by the DMC55 to keep the temperature of the heat exchanger cold, allowing a consistent additional energy saving. The dryer needs to be  during the entire compressed-air usage time, even if the compressed-air compressor works periodically.

10 Technical data

10.1 Technical data DRYPOINT RA VSD 800 – 2500 3/460/60

MODEL	DRYPOINT RA VSD	800	1000	1250	1500	1750	2000	2500
Air flow rate at nominal condition (1)	[scfm] [m ³ /h]	800 1358	1000 1698	1250 2122	1500 2547	1750 2971	2000 3396	2500 4245
Pressure DewPoint at nominal condition (1)	[l/min] [°F (°C)]	22640 38 (3)	28300 100 (38)	35375 34...115 (1...45)	42450 100 (38) max.158 (70)	49525 100 (7)	56600 203 (14)	70750 1.7 (0.12)
Nominal ambient temperature	[°F (°C)]							
Min...Max ambient temperature	[°F (°C)]							
Nominal inlet air temperature	[°F (°C)]							
Nominal inlet air pressure	[psig (barg)]							
Max. inlet air pressure	[psig (barg)]							
Air pressure drop - Δp	[psi (bar)]	1.7 (0.12)	1.6 (0.11)	1.7(0.12)	1.6 (0.11)	1.2 (0.08)	1.6 (0.11)	1.7 (0.12)
Inlet - Outlet connections	[FL ANSII]		3" # 150					4" # 150

		R134.a	R407C					
Refrigerant type		R134.a	R407C					
Refrigerant quantity (2)	[oz (kg)]	127 (3.60)	155 (4.40)	176 (5.00)	282 (8.00)	300 (8.50)	335 (9.50)	353 (10.00)
Cooling air fan flow	[cfm (m ³ /h)]	3180 (5400)	4240 (7200)	4360 (7400)	8480 (14400)		8710 (14800)	
Heat Rejection	[btu/hr (kW)]	36900 (10.8)	55700 (16.3)	69700 (20.4)	73400 (21.5)	80300 (23.5)	109300 (32.0)	136300 (39.9)
Standard Power Supply (2)	[PhV/Hz]		3/460/60					
Nominal electric consumption	[kW]	2.80	4.10	5.00	5.80	6.40	8.00	10.10
Full Load Amperage FLA	[A]	4.4	5.8	6.9	7.9	8.6	11.3	13.8
Max. noise level at 1 m	[dB(A)]	6.9	8.9	10.7	13.2	14.3	17.6	21.3
Weight	[lb (kg)]	550 (248)	620 (282)	700 (317)	1040 (470)	1200 (545)	1210 (549)	1370 (621)

		R134.a	R407C					
Refrigerant type		R134.a	R407C					
Refrigerant quantity (2)	[oz (kg)]	99 (2.80)	130 (3.70)	152 (4.30)	257 (7.30)	300 (8.50)	310 (8.80)	328 (9.30)
Max. cooling water inlet temp (3)	[°F (°C)]							
Min...Max. cooling water inlet pressure	[psig (barg)]				86 (30)			
Cooling water flow at 30°C	[US gpm (m ³ /h)]	3.70 (0.84)	6.30 (1.42)	9.70 (2.21)	11.20 (2.55)	12.20 (2.78)	21.60 (4.91)	22.10 (5.01)
Heat Rejection	[btu/hr (kW)]	36900 (10.8)	55700 (16.3)	69700 (20.4)	73400 (21.5)	80300 (23.5)	109300 (32.0)	136300 (39.9)
Control of cooling water flow			Automatic by valve					
Cooling water connection	[NPT-F]	3/4"	1"					
Standard Power Supply (2)	[PhV/Hz]		3/460/60					
Nominal electric consumption	[kW]	2.00	2.60	3.20	3.60	4.10	5.30	6.50
Full Load Amperage FLA	[A]	3.2	3.7	4.4	4.9	5.5	7.5	8.8
Max. noise level at 1 m	[dB(A)]	5.7	7.1	8.8	9.4	10.5	13.8	17.5
Weight	[lb (kg)]	510 (231)	580 (261)	640 (292)	960 (435)	1110 (502)	1120 (506)	1250 (568)

(1) The nominal condition refers to an ambient temperature of 100°F (38°C) with inlet air at 100 psig (7 barg) and 100°F (38°C).

(2) Check the data shown on the identification plate.

(3) Other temperature on request.

11 Technical description

11.1 Control panel

The control panel illustrated below is the only dryer-operator interface.



1 - Main switch

2 - Electronic controller
DMC55

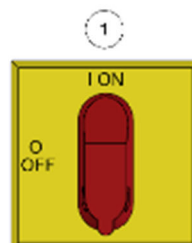

11.2 Operation

Operating principle - The dryer models described in this manual operate all on the same principle. The hot moisture laden air enters an air to air heat exchanger. The air then goes through the evaporator, also known as the air to refrigerant heat exchanger. The temperature of the air is reduced to approximately 36°F (2°C), causing water vapor to condense to liquid. The liquid is continuously coalesced and collected in the separator for removal by the condensate drain. The cool moisture free air then passes back through the air to air heat exchanger to be reheated to within 8°C lower than the incoming air to the dryer.

Refrigerant circuit - Refrigerant gas is exhausted by the compressor and exits at high pressure towards a condenser where heat is removed causing the refrigerant to condense to a high-pressure liquid state. The liquid is forced through an electronic expansion valve (EEV) where the resulting pressure drop allows the refrigerant to boil off at a predetermined temperature. Low-pressure liquid refrigerant enters the heat exchanger where heat from the incoming air is transferred causing the refrigerant to boil; the resulting phase change produces a low pressure and low temperature gas. Then the low-pressure gas goes back to the compressor, where it is re-compressed and begins the cycle again.

Operational description - The electronic controller constantly monitors the LP evaporation pressure, the HP condensing pressure and the T1 dew point temperature. During each start up phase, which lasts about three minutes, the compressor works at a set speed equivalent to approximately 40-50% of its maximum speed, to enable the lubricating oil to circulate correctly in the compressor at the beginning. If the evaporation pressure is too low, the controller activates the EHGBV electronic bypass valve which keeps the evaporation pressure constant above the freezing point. After three minutes, the controller adjusts the compressor speed to keep the evaporation pressure (and the dew point) constant if there are thermal load changes.

With a low thermal load condition and DCC parameter set to YES, the compressor runs at minimum speed. If the minimum compressor speed is still too high (the evaporation pressure falls below the set value and the dew point temperature reaches a value close to the freezing point), the controller will switch off the compressor. The compressor restarts when the dew point temperature and evaporation pressure rise above the set value. The combined operation of the CHV check valve and the EEV electronic expansion valve prevents immediate equalisation of the refrigerant circuit pressures and prolongs the compressor off condition. The EHGBV electronic bypass valve is activated before compressor start-up to equalise high and low refrigerant gas pressure.

With a low thermal load condition and DCC parameter set to NO, the controller keeps the compressor on at a minimum speed and adjusts the opening of the EHGBV electronic bypass valve to keep the evaporation pressure (and the dew point) constant. When the heat load increases, the EHGBV closes, and the controller regulates the compressor speed to keep the evaporation pressure (and the dew point) constant.

The electronic controller regulates the fan speed to keep the condensing pressure (BHP) constant (air-cooled). Using variable speed dryers, the energy consumption is proportional to the thermal load, allowing considerable energy savings in most applications.

11.3 Flow diagram (Air-Cooled)

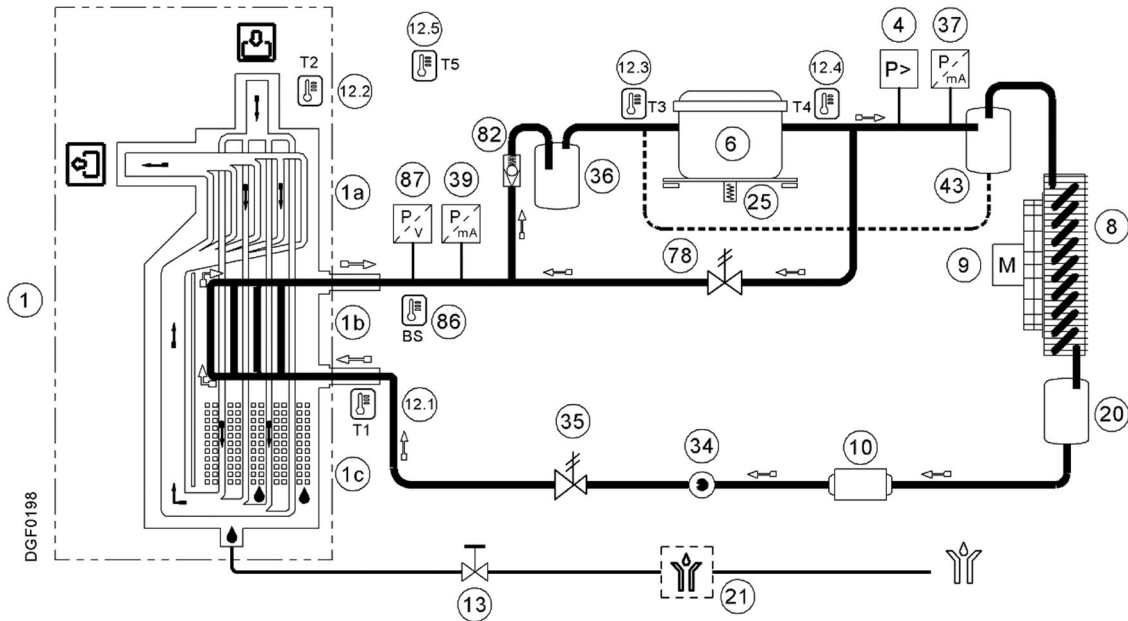

11.4 Flow diagram (Water-Cooled)

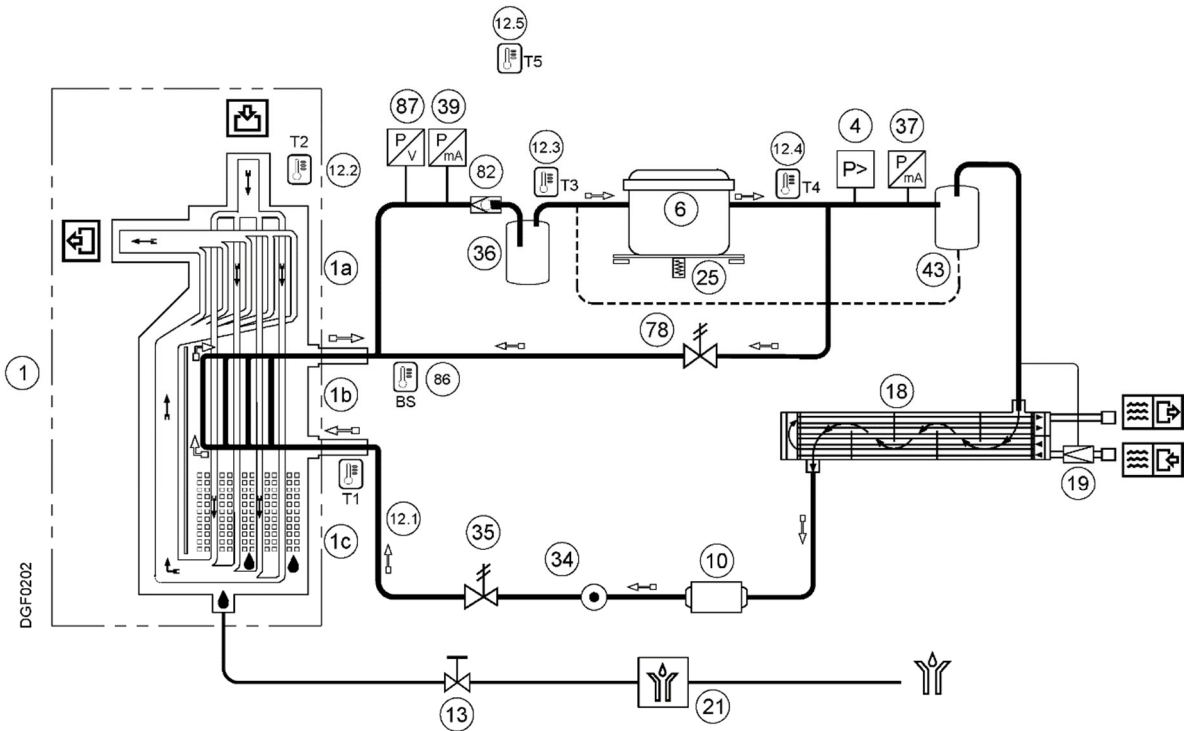

- | | |
|---|---|
| <p>1 Alu-Dry module</p> <p>1a Air-to-air heat exchanger</p> <p>1b Air-to-refrigerant heat exchanger</p> <p>1c Condensate separator</p> <p>4 Refrigerant pressure switch HPS</p> <p>6 Compressor</p> <p>8 Condenser (Air-Cooled)</p> <p>9 Condenser fan (Air-Cooled)</p> <p>10 Filter dryer</p> <p>12.1 T1 Temperature probe – DewPoint</p> <p>12.2 T2 Temperature probe – Air IN</p> <p>12.3 T3 Temperature probe – Compressor suction</p> <p>12.4 T4 Temperature probe – Compressor discharge</p> <p>12.5 T5 Temperature probe – Ambient temperature</p> <p>13 Condensate drain service valve</p> <p>➔ Compressed air flow direction</p> | <p>18 Condenser (Water-Cooled)</p> <p>19 Condenser water regulating valve (Water-Cooled)</p> <p>20 Refrigerant accumulator</p> <p>21 Electronic drainer</p> <p>25 Compressor crankcase heater</p> <p>34 Liquid sight glass</p> <p>35 Electronic Expansion Valve EEV</p> <p>36 Liquid separator</p> <p>37 Refrigerant pressure transducer BHP</p> <p>39 Refrigerant pressure transducer BLP</p> <p>43 Oil separator (RA VSD 2000-2500)</p> <p>78 Electronic by-pass valve EHGBV</p> <p>82 Check valve CHV</p> <p>86 Electronic Expansion Valve temperature sensor BS</p> <p>87 Electronic Expansion Valve pressure transducer BP</p> <p>➔ Refrigerant gas flow direction</p> |
|---|---|

11.5 Refrigerating compressor

The refrigerating compressor is the pump in the system, gas coming from the evaporator (low pressure side) is compressed up to the condensation pressure (high pressure side).

It is used a scroll fully hermetic compressor encapsulated with a BLDC (Brush Less Direct Current) motor which is the latest and most efficient technology available for this application. Compressor motor speed is completely handled by an heavy duty variable speed drive, with a customized software capable to ensure a very wide capacity regulation. Compressor motor protection is completely managed by the variable speed drive.

11.6 Condenser (Air-Cooled)

The condenser is the component in which the gas coming from the compressor is cooled down and condensed becoming a liquid. Mechanically, a serpentine copper tubing circuit (with the gas flowing inside) is encapsulated in an aluminium fin package.

The cooling operation occurs via a high efficiency fan(s) AC motor, creating airflow within the dryer, moving air through the fin package. The fan(s) motor speed is completely handled by an heavy duty variable speed drive, with a customized software capable to ensure a very wide capacity regulation.

It's mandatory that the ambient air temperature does not exceed the nominal values. It is also important to keep the condenser unit free from dust and other impurities.

11.7 Condenser (Water-Cooled)

The condenser is the component in which the gas coming from the compressor is cooled down and condensed becoming a liquid. Basically it is a water/refrigerating gas exchanger where the cooling water lowers the temperature of the refrigerating gas.

The temperature of the inlet water must not exceed the nominal values. It must also guarantee an adequate flow and that the water entering the exchanger is free from dust and other impurities.

11.8 Condenser water regulating valve (Water-Cooled)

The condenser water regulating valve is used to keep the condensing pressure/temperature constant when the Water-Cooled is being used. Thanks to the capillary tube, the valve detects the pressure in the condenser and consequently adjusts the water flow. When the dryer stops the valve automatically closes the cooling water flow.



The condenser water regulating valve is an operating control device.

The closure of the water circuit from the pressure condenser water regulating valve cannot be used as a safety closure during service operations on the system.



ADJUSTMENT

The condenser water regulating valve is adjusted during the testing phase to a pre-set value that covers 90% of the applications. However, sometimes the extreme operating conditions of the dryer may require a more accurate calibration.

During start-up, a qualified technician should check the condensing pressure/temperature and if necessary adjust the valve by using the screws on the valve itself.

To increase the condensing temperature, turn the adjusting screws counter-clockwise; to lower it turn the screws clock-wise.

Water valve setting: R134.a pressure 10 barg (± 0.5 bar) / 145 psig (± 7 psi)

R407C pressure 16 barg (± 0.5 bar) / 218 psig (± 7 psi)

11.9 Filter dryer

Traces of humidity and slag can accumulate inside the refrigerant circuit. Long periods of use can also produce sludge. This can limit the lubrication efficiency of the compressor and clog the expansion valve. The function of the filter drier, located before the expansion valve, is to eliminate any impurities from circulating through the system.

11.10 Electronic Expansion Valve (EEV)

The electronic expansion valve (EEV) is an expansion device which is composed by a valve body operated from a stepper motor. This component is managed from its driver according to heat exchanger superheating.

This parameter is calculated from the driver using a temperature sensor BS and a pressure sensor BP installed at evaporator outlet refrigerant pipe. The driver operates the motor opening or closing the electronic expansion valve (EEV) in order to keep constant at the setpoint the superheating.

On this dryer type, every Alu-Dry module has its electronic expansion valve EEV which control its superheating independently.

In case of multiple Alu-Dry module (1...n), every group composed by electronic expansion valve EEV (1...n), every temperature sensor BS (1...n), every pressure sensor BP (1...n) and every driver DRV (1...n) is marked with a sticker. The number on the sticker (1...n) identify the valve group.

11.11 Alu-Dry module

The heat exchanger module houses the air-to-air, the air-to-refrigerant heat exchangers and the demister type condensate separator. The counter flow of compressed air in the air-to-air heat exchanger ensures maximum heat transfer. The generous cross section of flow channel within the heat exchanger module leads to low velocities and reduced power requirements. The generous dimensions of the air-to-refrigerant heat exchanger plus the counter flow gas flow allows full and complete evaporation of the refrigerant (preventing liquid flood back to the compressor). The high efficiency condensate separator is located within the heat exchanger module. No maintenance is required and the coalescing effect results in a high degree of moisture separation.

11.12 Refrigerant pressure switches LPS – HPS

HPS: This high-pressure controller device, located on the discharge side on the compressor, is activated when the pressure exceeds the pre-set value. It features a manual-resetting button mounted on the protection device.

Calibrated pressure:	R134.a	Stop 20 barg / 290 psig - Manual reset (P<14 bar / 203 psig)
	R407C	Stop 30 barg / 435 psig - Manual reset (P<23 bar / 334 psig)

11.13 Compressor crankcase heater

At low temperatures oil can more easily be mixed with the refrigerant gas. So, when the compressor starts, oil can be drawn into the refrigeration circuit and liquid flood back to the compressor could occur.

To prevent this, an electrical resistance heater is installed in the bottom part of the compressor. When the system is powered and the compressor is not running, this heater keeps the oil at the correct temperature.



Note!

During short-term shut down (max. two to three days), it is advisable to leave the dryer and the control panel connected to the supply current circuit. Otherwise, it would be necessary at a restart of the dryer to wait two hours, until the oil in the compressor has reached the specified operating temperature.

11.14 Electrical panel fan

Drivers enclosed in the electrical panel dissipates a consistent amount of heat. If the electrical panel temperature rises above a set limit (40 °C), a dedicated fan is activated to keep properly cooled the electrical panel and the drivers.

It is important to keep the electric panel air intake filter free from dust and other impurities, furthermore it must be regularly cleaned.

NOTE!- With low temperatures, the electric panel fan will remain OFF.

11.15 DMC55 electronic control unit

The DMC55 electronic control unit is a device which controls the dryer's functional processes, provides a dialogue interface for the operator, and consists of a power module within the control panel and a touch screen module positioned on the front panel of the dryer. Both modules are connected together via data communication and power supply cables. The operator can use the touch screen display to manage operating functions, view Alarms/Warnings, and set process parameters.

Switch the dryer on and wait for the control unit initialisation process. After about 45 seconds the display will show the main screen:

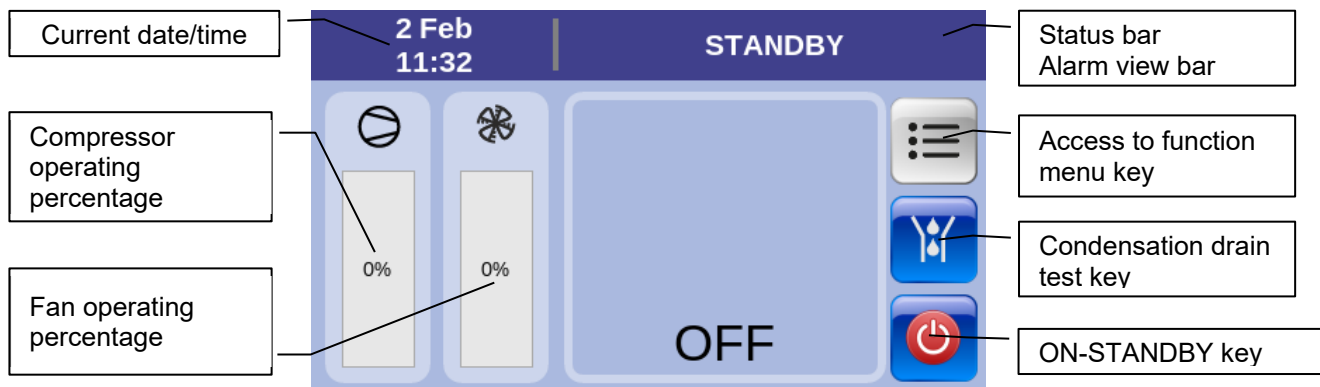

11.15.1 Starting the dryer ("ON" mode)

Hold the  key for 3 seconds to start the dryer. The dryer will start up, and the status bar will turn green and display **ON**.

NOTE During the start up phase, which lasts about 3 minutes, the compressor works at a set speed equivalent to approximately 40-50% of its maximum speed, to enable the lubricating oil to circulate correctly in the compressor at the beginning. This phase is illustrated with a bar symbol

under the  icon which gradually becomes blue and shows the time that has lapsed since the dryer started. After three minutes, the bar disappears and the dryer works normally.

The display will show:

- ⇒ Current date/time and "ON" status of the dryer
- ⇒ Compressor operating percentage
- ⇒ By-pass valve opening percentage (only if > 0%)
- ⇒ Fan operating percentage (air cooling)
- ⇒ Dew point temperature

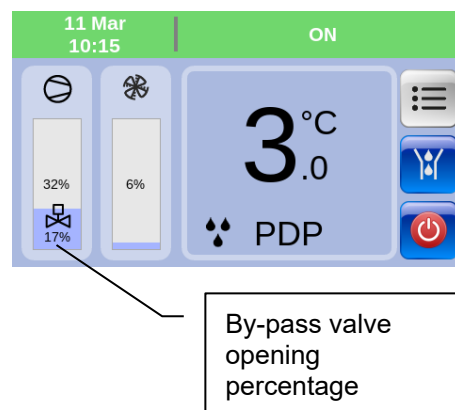

11.15.2 Stopping the dryer ("STANDBY" mode)

Hold the  key for 3 seconds to stop the dryer. The dryer will stop, and the status bar will turn blue and display **STANDBY**.

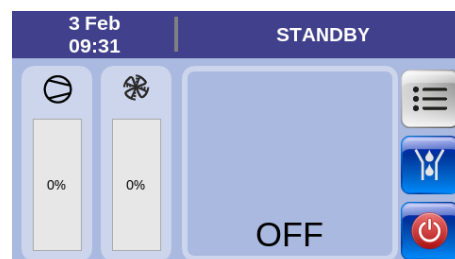

11.15.3 Condensation drain test



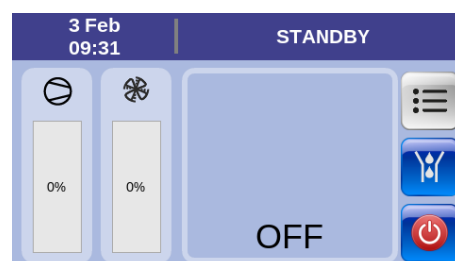

Hold the  key to perform the condensation drain test. Release the key to finish the test.

NOTE The condensation drain test can be performed at any time, regardless of the dryer status displayed on the status bar.





Technical description

11.15.4 Chilling circuit process values

- 1- With the dryer operating press  to access the dryer's menu.
- 2- Press  to display the chilling circuit diagram and the dryer's instantaneous process values:
T1 - BT1 probe - Dew point temperature
T2 - BT2 probe - Air temperature at exchanger inlet
T3 - BT3 probe - Temperature of refrigerant gas on compressor suction side
T4 - BT4 probe - Temperature of refrigerant gas on compressor supply side
T5 - BT5 probe - Room temperature
HP - BHP transducer – Pressure of refrigerant gas on compressor supply side
LP - BLP transducer – Pressure of refrigerant gas on compressor suction side
%  - Compressor operating percentage
 0% - By-pass valve opening percentage
%  - Fan operating percentage

- 3- Hold the  key to perform the condensation drain test. Release the key to finish the test.

- 4- Press the  key to display the log file process values expressed graphically or numerically for the last 60 minutes of dryer operation. The default graph includes traces for all 10 process values.

- 5- Use the  keys to display/hide the corresponding coloured traces.
- 6- Touch the graph on the screen to position the cursor roughly near the required time.
- 7- Use the cursor keys to fine tune the position of the graph cursor on the required time. Positioning accuracy is +/- 15 seconds.
- 8- The table on the right of the screen displays the process values stored in the time period selected by the graph cursor in numerical format.

NOTE The stored process values, which are available in numerical or graph format, relate to the last 60 minutes of dryer operation. Stored process values that are not within this time frame are permanently deleted automatically.

- 9- Press  to return to the previous screen.

Recording of process values on a USB drive:



This function allows you to record the process values over a certain time on a USB storage drive.

- 10- Install a USB storage drive as described in "Installing and removing the

USB storage drive" and press . Set the recording time with the cursor keys.



Example: I want to record the process values of the dryer for two hours and 30 minutes, sampling the values every 90 seconds.

Setting: hour→2, minutes→30, period→90

- 12- Start the recording with , or  to exit the command. The screen indicates the recording progress and the time remaining to the end.

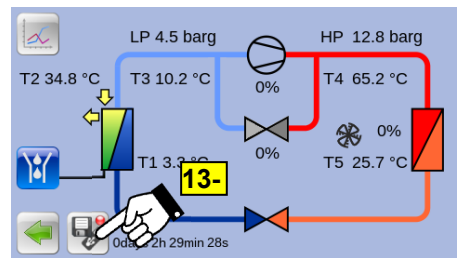
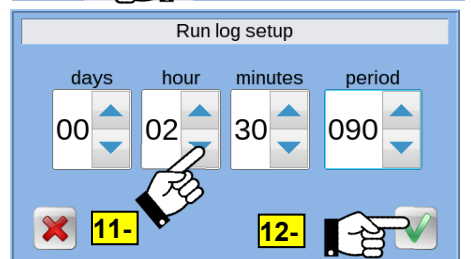
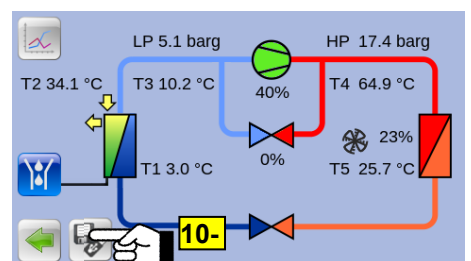
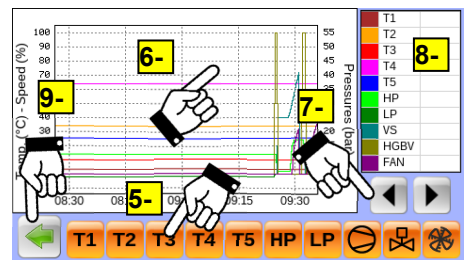
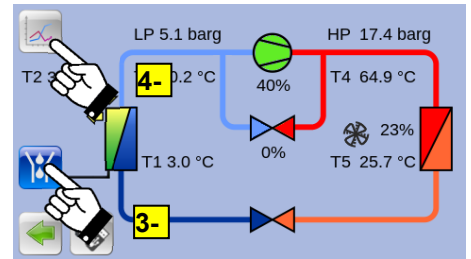
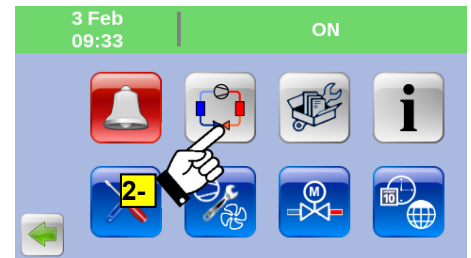
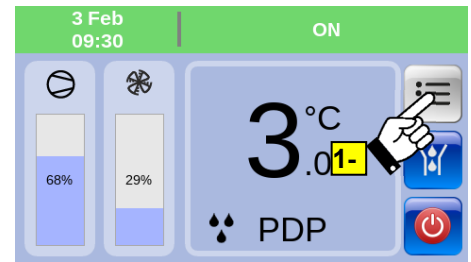
- 13- To stop recording, press .



14- Confirm your intention to stop the recording in progress with , or  to exit the command

Once you have finished recording, remove the USB drive as described in the section "Installing and removing the USB storage drive."

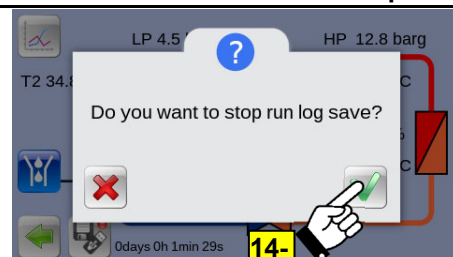

11.15.5 WARNING condition

A **WARNING** is an irregular event that must be flagged to operators/maintenance technicians. It does not jeopardise the safety of the machine/operators, with the exception of the HdS parameter (STOP dryer due to high dew point), which can be set to stop the dryer.

In the presence of a Warning the status bar shows a description of the event and turns flashing orange. In this condition it is not possible to clear the Warning as the cause is still present.

When a Warning is no longer active but has not been cleared, the status bar shows a description of the event and is permanently lit (orange). In this condition the Warning can be cleared as the cause has been removed.



With dryer operating: the presence of one or more Warnings is flagged on the display with the status bar changing from green to orange. If there are several active anomalies simultaneously, the status area displays them in order.

When the dryer is off: one or more Warnings are not highlighted on the display, other than the W11 Warning "Low ambient temperature" which automatically clears.



It is only when the operator wants to start the dryer with the  key that the control unit still enables the dryer to be started in the presence of a Warning, and displays the Warning status by changing the colour of the status bar (orange).

Clearing a Warning:

- 1- Touch the screen on the status bar where the Warning is shown.
- 2- Press  to confirm the Warning is to be cleared, or  to without clearing.

NOTE After clearing Warnings the operator/maintenance technician must verify/solve the problem that caused the Warning with the dryer.

Warnings never clear automatically, with the exception of Warning no. W5 (malfunction of electronic condensation drainer), which is factory-set to enable automatic clearing setting.

Technical description

ID	Warning description	Set	Delay	Reset
W1	BT1 probe - Dew point temperature Low temperature	$T1 < -1.0^{\circ}\text{C}$	3 min	$T1 \geq 0.0^{\circ}\text{C}$
W2	BT1 probe - Dew point temperature High temperature	$T1 > \text{HdA}$ parameter	Parameter Hdd	Parameter HdA-1K
W3	BT2 probe - Inlet air temperature Fault	Fault probe	Flag immediately	Reset probe
W4	BT3 probe – Compressor suction temperature Fault	Fault probe	Flag immediately	Reset probe
W5	ELD condensation drainer Malfunction	Opening Digital Input 5	20 min	Closing Digital Input 5
W5 Dn nn	ELD condensation drainer Specific Warnings - Consult your dealer	-	-	-
W6	Scheduled service Time expired	Parameter SrV	Flag immediately	Timer reset
W7	BT4 probe – Refrigerant fluid temperature High compressor supply side temperature (supply over normal limits but within safe limits)	$T4 > 100.0^{\circ}\text{C}$	60 sec	$T4 < 95.0^{\circ}\text{C}$
W8	BLP transducer - Evaporation pressure High pressure	R407C $\text{LP} > 6.8 \text{ barg}$ R134.a $\text{LP} > 5.0 \text{ barg}$	6 min	R407C $\text{LP} \leq 6.8 \text{ barg}$ R134.a $\text{LP} \leq 5.0 \text{ barg}$
W9	BHP transducer - Condensation pressure Low Pressure	Variable	10 min	Variable
W10	BHP transducer - Condensation pressure High pressure	Variable	10 min	Variable
W11	BT5 probe - Room temperature Low temperature	$T5 < 0.0^{\circ}\text{C}$	5 min	$T5 \geq 1.0^{\circ}\text{C}$
W12	BT5 probe - Room temperature High temperature	$T5 > 45.0^{\circ}\text{C}$	5 min	$T5 \leq 42.0^{\circ}\text{C}$
W13	BT5 probe - Room temperature Fault	Fault probe	Flag immediately	Reset probe
W14	BT2 probe - Inlet air temperature Low temperature	$T2 < 10.0^{\circ}\text{C}$	5 min	$T2 \geq 11.0^{\circ}\text{C}$
W15	BT2 probe - Inlet air temperature High temperature	$T2 > 70.0^{\circ}\text{C}$	5 min	$T2 \leq 65^{\circ}\text{C}$

NOTE: Refer to the "Troubleshooting" section for possible causes and solutions to the Warning.

11.16 ALARM condition

An **ALARM** is an irregular event that always causes the dryer to switch off to ensure the safety of operators and the machine. In the presence of an Alarm the status bar shows a description of the event and turns flashing red. In this condition it is not possible to clear the Alarm as the cause is still present.

When an Alarm is no longer active but has not been cleared, the status bar shows a description of the event and is permanently lit (red). In this condition the Alarm can be cleared as the cause has been removed.

With dryer operating: the presence of one or more Alarms is flagged on the display with the status bar changing from green to red. If several Alarms are active simultaneously, the status area displays one Alarm at a time until the displayed Alarm is reset.



When the dryer is off: an Alarm is not displayed, except for Alarms A6 "Ice" and A14 "Inverted feeding phases."

It is only when the operator wants to start the dryer with the  key that the control unit prevents the dryer starting up and displays the Alarm status by changing the colour of the status bar (red).

Clearing an Alarm:



1- Touch the screen on the status bar where the Alarm is shown to display a list of stored Alarms.

2- Touch the screen on the Alarm to be cleared.

3- Press  to confirm the Alarm is to be cleared, or  to without clearing.

Downloading the Alarm log:

4- Install a USB storage drive as described in "Installing and removing the USB storage drive" and press  to download the Alarm log.

5- Confirm with  the intention to download, or  to exit the command. Remove the USB drive as described in the section "Installing and removing the USB storage drive."

6- Press  to return to the previous screens.

NOTE The dryer must be restarted manually by the operator/maintenance technician after Alarms are cleared. Automatic restart is not available after an Alarm has been cleared. Before restarting, the operator/maintenance technician must verify/solve the problem that caused the Alarm on the dryer. Alarms never clear automatically.

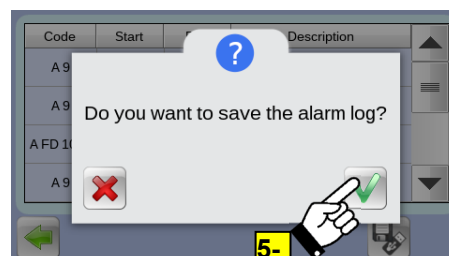
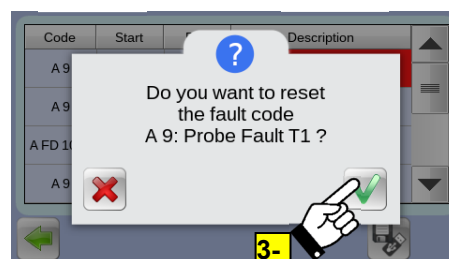
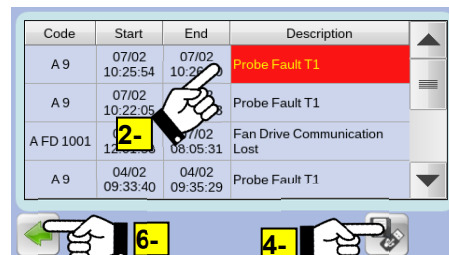
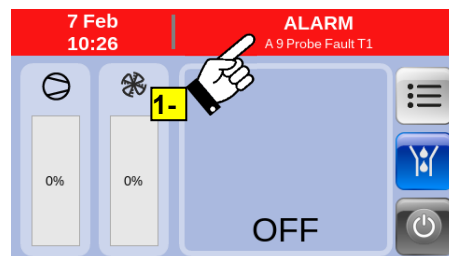

Technical description

ID	Alarm description	Set	Delay	Reset
A1	HPS pressure switch - Refrigerant high pressure	Opening Digital Input HPS	Flag immediately	Closing Digital Input HPS
A2	BLP transducer - Evaporation pressure Parameterised for "LPS pressure switch" function	R407C LP < 1.7 barg R134.a LP < 0.7 barg	2 sec	R407C LP > 2.7 barg R134.a LP > 1.7 barg
A3	BLP transducer - Evaporation pressure Low Pressure	LP < 4.0 barg	5 min	LP > 4.3 barg
A4	BT4 probe – Refrigerant fluid temperature High compressor supply side temperature (over safe limits)	T4 > 110.0°C	60 sec	T4 ≤ 100.0°C
A5	Chiller compressor QC1 protection Compressor overload	Opening Digital Input 4	Flag immediately	Closing Digital Input 4
A6	BT1 probe - Dew point temperature Condensation frozen	T1 < -3.0°C	60 sec	T1 ≥ 0°C
A7	BLP transducer - Evaporation pressure Fault	Fault probe	Flag immediately	Reset probe
A8	BHP transducer - Condensation pressure Fault	Fault probe	Flag immediately	Reset probe
A9	BT1 probe - Dew point temperature Fault	Fault probe	Flag immediately	Reset probe
A10	BT4 probe – Refrigerant fluid temperature Fault	Fault probe	Flag immediately	Reset probe
A11	BHP and BLP transducers Differential low pressure	HP-LP < 2.5 barg	[1]	Restore normal conditions
A12	BLP transducer - Evaporation pressure High pressure	R407C LP > 7.3 barg R134.a LP > 5.5 barg	[2]	Restore normal conditions
A13	BHP transducer - Condensation pressure Low Pressure	Variable	[2]	Restore normal conditions
A15.0	INV2 Drive - Fan Fan speed out of control	→ From INV2 Drive	60 sec	Restore normal conditions
A16	INV1 Drive - Chiller compressor Chiller compressor speed out of control	→ From INV1 Drive	60 sec	Restore normal conditions
A17	BLP / BHP transducers HP and LP pressures unbalanced at start-up	abs (HP-LP) ≥ 1.0 barg	5 min	Restore normal conditions
A18.n	EEVn Electronic expansion valve High refrigerant gas overheating value	→ From DRVn module	10 min	Restore normal conditions
A E 1001	DMC55 Controller - Interrupted communication between the display and power module	Communication interrupted	5 sec	Communication interrupted
A KD 1001	INV1 Drive - Chiller compressor Communication interrupted			
A FD 1001	INV2 Drive - Fan Communication interrupted			
A Vn 1001	DRVn module - EEVn electronic expansion valve control Communication interrupted			
A KD nnn	INV1 Drive - Chiller compressor Specific Drive Alarms	→ From INV1 Drive	5 sec	Restore normal conditions
A FD nnn	INV2 Drive - Fan Specific Drive Alarms	→ From INV2 Drive	5 sec	Restore normal conditions
A Vn nnn	DRVn module - EEVn electronic expansion valve control Module-specific Alarms	→ From DRVn module	5 sec	Restore normal conditions

[1] – 15 minutes at dryer start-up. 60 seconds during normal operation.

[2] – 15 minutes at dryer start-up. 10 minutes during normal operation.

NOTE: Refer to the "Troubleshooting" section for possible causes and solutions to the Alarm.

11.16.1 Alarm history

1- With the stopped or operating dryer press  to access the dryer's menu.

2- Press  to display the history file for the last 50 stored Alarms.



3- Scroll through the list of Alarms using the cursor keys.

Alarms are stored chronologically.

The most recent event is added to the top of the list and replaces the oldest which is removed from the bottom of the list.

Downloading the Alarm log:

4- Install a USB storage drive as described in "Installing and removing the USB storage drive" and press  to download the Alarm log.

5- Confirm with  the intention to download, or  to exit the command. Remove the USB drive as described in the section "Installing and removing the USB storage drive."

6- Press  to return to the previous screens.

NOTE Only Alarms are stored in the log file. Warnings are not stored. If power is cut off from the dryer the log file with the stored Alarms will NOT be deleted.

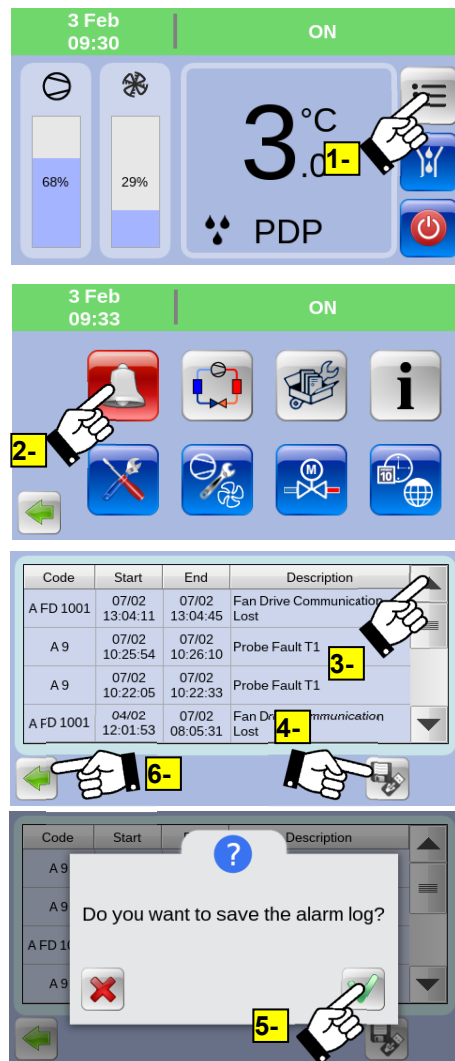

Technical description

11.16.2 Installing and Removing the USB storage drive

NOTE The following operations should only be performed by qualified and trained personnel.



Installing the USB storage drive

- Remove power from the dryer and ensure that it cannot be restarted accidentally.
- Open the control panel door with the special key provided with the dryer.
- Insert a formatted USB storage drive (USB stick) into the dedicated connector on the back of the display module.
- Close the control panel door carefully.
- Restore power to the dryer

Removing the USB storage drive

- Remove power from the dryer and ensure that it cannot be restarted accidentally.
- Open the control panel door with the special key provided with the dryer.
- Remove the USB storage drive (USB stick).
- Close the control panel door carefully.
- Restore power to the dryer.

11.16.3 Compressor and fan drive process values





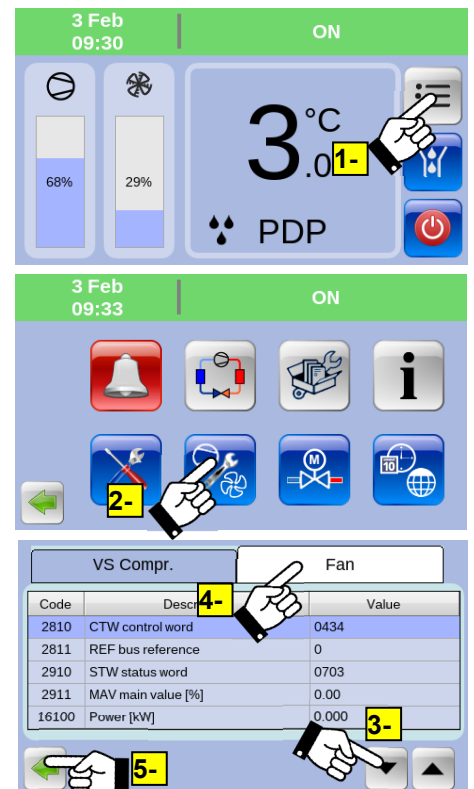

- 1- With the dryer operating press  to access the dryer's menu.
- 2- Press  to display the list of diagnostic values for the compressor drive ("VS Compr." tab).
- 3- Scroll through the list of values using the cursor keys.
- 4- Touch the "Fan" tab to display the list of diagnostic values for the fan Drive.
- 5- Press  to return to the previous screens.

NOTE

The dryer must be running to display the values, with the compressor and fan running.



11.16.4 Electronic expansion valve process values

- 1- With the dryer operating press  to access the dryer's menu.
 - 2- Press  to display the list of instantaneous process values for the electronic expansion valve.
 - 3- Scroll through the list of values using the cursor keys.
 - 4- Press  to display the values log file of "SH" (overheating of the refrigerant measured at the heat exchanger outlet) and "OD" (electronic expansion valve opening percentage) expressed in graphical and numerical format, related to the last 60 minutes of dryer operation. The default graph includes traces for both the process values.
 - 5- Use the   keys to display/hide the corresponding coloured traces.
 - 6- Touch the graph on the screen to position the cursor roughly near the required time.
 - 7- Use the cursor keys to fine tune the position of the graph cursor on the required time. Positioning accuracy is +/- 15 seconds.
 - 8- The table on the right of the screen displays the process values stored in the time period selected by the graph cursor in numerical format.
- NOTE** The stored process values, which are available in numerical or graph format, relate to the last 60 minutes of dryer operation. Stored process values that are not within this time frame are permanently deleted automatically.
- 9- Press  to return to the previous screens.

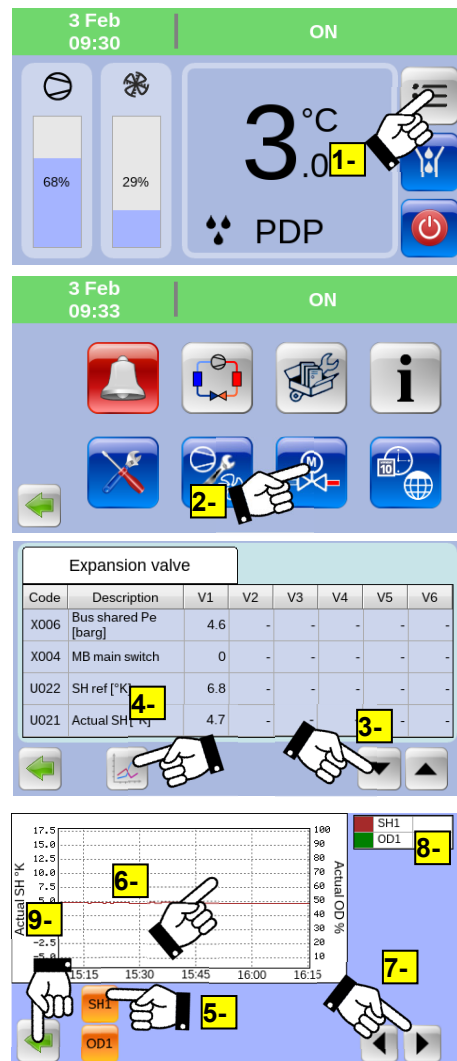

Technical description

11.16.5 Energy saving data and operating hours

1- With the stopped or operating dryer press  to access the dryer's menu.

2- Press  to display the energy consumption / energy-saving data and the dryer's operating hours.



NOTE

The following operations should only be performed by qualified and trained personnel.

3- With the stopped dryer press the Reset key to reset the count of the hours remaining before the next service (parameter SrV default 8000 hours). This function is useful in the case of maintenance carried out on the dryer before the hours remaining till the next service have lapsed.

This is a PIN-protected function (no. 3333) to prevent the counter being reset accidentally.

4- Press Reset to clear the partial energy savings counter.

5- Press  to confirm the counter is to be cleared, or  to without clearing.

6- Press  to return to the previous screens.

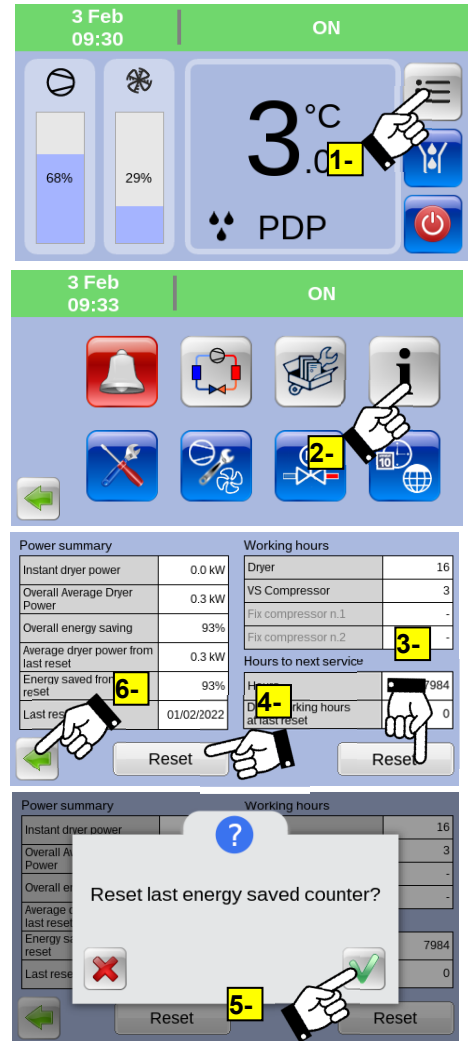

The image shows a sequence of three screenshots from a dryer's control panel. The top screenshot shows the main display with a temperature of 3.0°C and a 'PDP' indicator. A hand icon points to the menu icon (three horizontal lines) in the top right corner. The middle screenshot shows the menu screen with various icons. A hand icon points to the 'i' (info) icon in the top right. The bottom screenshot shows the 'Power summary' and 'Working hours' screens. A hand icon points to the 'Reset' button at the bottom. A dialog box appears with the text 'Reset last energy saved counter?' and a hand icon pointing to the 'Checkmark' icon to confirm the reset.

Power summary		Working hours	
Instant dryer power	0.0 kW	Dryer	16
Overall Average Dryer Power	0.3 kW	VS Compressor	3
Overall energy saving	93%	Fix compressor n.1	-
Average dryer power from last reset	0.3 kW	Fix compressor n.2	3-
Energy saved from reset	93%	Hours to next service	-
Last reset	01/02/2022	Hours to next service	7984
		Drying hours at last reset	0

11.16.6 Remote start/stop, remote reset of Warnings/Alarms

The power module of the controller is equipped with two digital inputs (DI6 and DI8, M10 connector) for the remote control of:

- dryer RUN / STOP
- RESET Warnings/Alarms

NOTE

Preliminary operations A-, B-, C-, D-, E- must only be performed by qualified and trained personnel.

A- Remove power from the dryer and ensure that it cannot be restarted accidentally.

B Open the control panel door with the special key provided with the dryer

C- Wire a potential-free contact [1] between the "DI6" and "GND" terminals of the M10 connector ("REMOTE ON-OFF" command).

D- Wire a potential-free contact [1] between the "DI8" and "GND" terminals of the M10 connector ("REMOTE RESET" command).

E- Restore power to the dryer and switch it on at the main switch.

1- With the stopped dryer press  to access the dryer's menu.

2- Press  to display the list of process parameters and respective current settings ("USER" profile).

3- Touch the "DrC" parameter on the screen and set it to "REMOTE".

Confirm the setting with , or  to exit the command.

4- Press  to return to the previous screens.

5- Close the "REMOTE ON-OFF" contact. The dryer will start up and the status bar will turn green and display REMOTE ON.

6- Open the "REMOTE ON-OFF" contact. The dryer will stop and the status bar will turn blue and display REMOTE STANDBY.

NOTE In "REMOTE" operating mode:

- It is impossible to operate and stop the dryer with commands from the display.
- It is impossible to manage and reset Alarms from the display.
- It is possible to carry out all other operations, such as the condensation drain test, the management of Alarms and access to the function menu.
- Warnings/Alarms can be reset remotely via the "REMOTE RESET" contact (see section "Changing process parameters", table "Advanced parameters").



[1] Use only a clean contact free from electric potential and suitable for low voltage. Ensure there is adequate insulation on potentially hazardous live parts.

11.16.7 "Alarm" and "dryer running" signal contacts

The power module of the electronic controller is equipped with two potential-free contacts for signalling about:

- dryer Warning / Alarm (RL3 contact, M3 connector)
- dryer in STANDBY / ON (RL4 contact, M4 connector). STANDBY=contact open, On=contact closed

The operating logic of the RL3 Alarm contact depends on the setting of the ACM parameter (see specific paragraph).

11.16.8 4-20mA analogue output

The power module of the electronic controller is equipped with one analogue output for external indication of the dew point temperature (AO3 output, M9 connector):

The programming of the analogue output depends on the DPMIn and DPMMax parameters setting (refer to the specific paragraph).

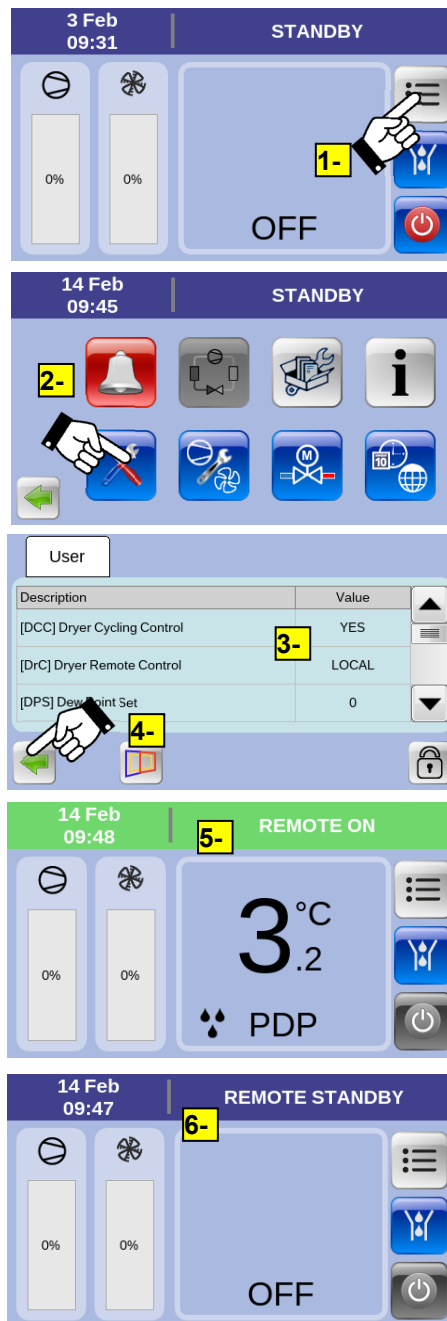

Technical description

11.16.9 RS485 MODBUS RTU communication port

The control unit power model is provided with a communication port (M14 connector) for the remote dryer monitoring via a supervision system.

Contact the manufacturer for further information .

11.16.10 Changing process user parameters



1- With the stopped or operating dryer press  to access the dryer's menu.

2- Press  to display the list of process parameters.

3- Scroll through the list of parameters using the cursor keys.

4- Touch the screen on the parameter to be changed to display the possible settings, then select one of the settings.

If the parameter to be changed requires a numerical value, set the new value using the numerical keypad within the max and min limits shown.

5- Confirm the setting by pressing  or  to return to the parameter list without making any changes. Repeat operations 3- 4- 5- for all parameters to be changed.

6- Press  to access the advanced process parameters (service). To avoid inappropriate operations, access to the advanced parameters is protected by a Service PIN.

7- Press  to access the "VS Compressor Envelope" page. To avoid inappropriate operations, access to the page is protected by a PIN (3333).

8- Press  to return to the previous screens.

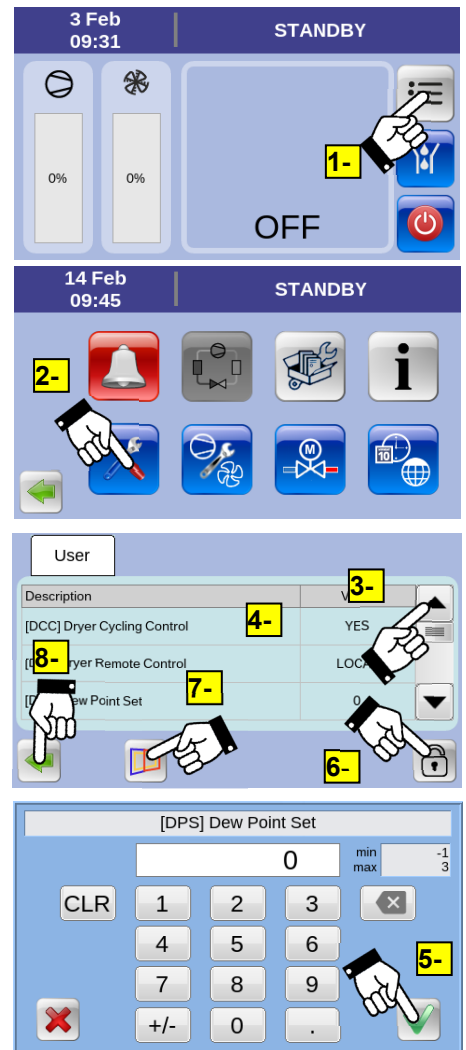

User parameters

ID	Description	Limits	Scale	Factory setting
DCC	Refrigerant compressor operating mode at low thermal load YES = Cyclic operation ON-OFF NO = Continuous operation	YES / NO [1]	-	YES
DrC	Dryer control modes	Local / Remote / Modbus	-	Local
DPS	Dew point level -1 = Performance; 0 = Standard; 1 = Eco; 2 = Eco plus; 3 = [2]	-1...3	1	0
HdA	W2 Warning intervention threshold High dew point temperature	0...25.0°C	0.1°C	20.0°C
Hdd	W2 Warning delay time High dew point temperature	1...20 minutes	1 minute	15 minutes
HdS	Dryer stop for W2 Warning High dew point temperature Yes = Stops the dryer No = Does not stop the dryer	YES / NO	-	NO
SrV [5]	Hours remaining till the next service (With SrV = 0 the counter is disabled)	0...12000 hours	1 hour	8000 hours
AS	Automatic dryer restart following a voltage drop YES = the dryer restarts automatically (if it had been on) NO = The dryer must be restarted using the  key.	YES / NO	-	NO
Ard	Enables/disables the W5 Warning to be cleared automatically YES = automatic clearing NO = manual clearing	YES / NO	-	YES
ACM	Selects the triggering logic of the RL3 Alarm contact 1 = any Alarm + W2 Warning 2 = any Alarm + any Warning 3 = any Alarm 4 = any Alarm + W2 Warning + W11 Warnings	1...4	1	1
IPA	Modbus address	1...247	1	1
MBP	Modbus communication parameters Baud Rate, Parity, Stop bit	-	-	19200 Even 1
DPMin	AO3 analogue output (M9 connector) Minimum dew point value that sets the output to 4mA	-10.0... 10.0°C	0.1°C	-10.0°C
DPMax	AO3 analogue output (M9 connector) Maximum dew point value that sets the output to 20mA	25.0... 50.0°C	0.1°C	40.0°C

Technical description

Advanced parameters (service)

ID	Description	Limits	Scale	Factory setting
RbP	Warning/Alarm clearing YES = resetting only allowed locally NO = resetting allowed locally and remotely [3].	YES / NO	-	NO
NoA	With RbP = YES - Maximum number of local resets allowed within the time frame defined in TtPR	1...10	1	1
TtPR	With RbP = YES - Time frame within which the maximum number of local resets defined in NoA can be performed.	0...24 hours [4]	1 hour	1 hour
PSPR	"Scheduled service" W6 Warning clearing YES = Warning reset only allowed with the Service PIN [5]. NO = Warning reset without PIN	YES / NO	-	NO

[1] – Do not set DCC = NO with ambient temperature below 15°C. Alarms A11 and A13 could trigger with the risk of damaging the dryer. In this case, reset the setting DCC = YES.

[2] - With DPS = 3, the dew point varies according to the ambient temperature.

[3] - With RbP = NO, the maximum number of remote resets allowed, within 60 minutes, is three.

[4] - With TtPR = 0, when NoA Alarms are reached, the dryer asks for the Service PIN to be entered to reset the Alarm.

[5] - With PSPR = YES, the SrV parameter can only be modified with the Service PIN.

11.16.11 List of spare parts

1- With the stopped or operating dryer press  to access the dryer's menu.

2- Press  to display the list of the dryer's spare parts.

3- Scroll through the list of spare parts using the cursor keys

Downloading the list of spare parts:

4- Install a USB storage drive as described in "Installing and removing the USB

storage drive" and press  to download the spare parts list. Remove the USB drive as described in the section "Installing and removing the USB storage drive."

5- Press  to return to the previous screens.

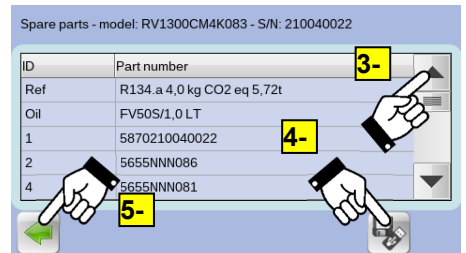
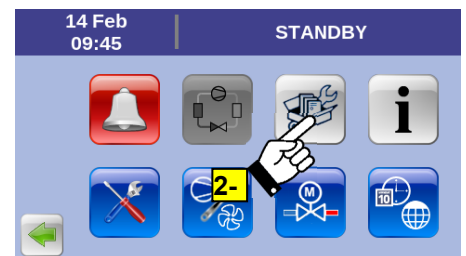
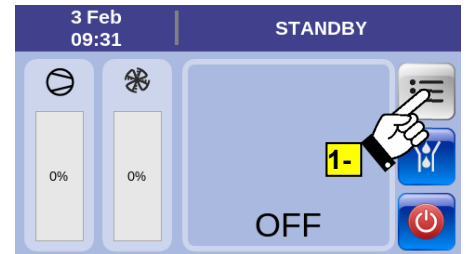

11.16.12 System settings and weekly timer

1- With the stopped or operating dryer press  to access the dryer's menu.

2- Press  to access the system settings. Then touch the screen at the function you want to change. You can change/update the following functions:

- system language
- Current date and time
- date format (dd/mm/yy or mm/dd/yy)
- time format (24h or 12h)
- measurement units of temperature and pressure (°C/bar or °F/psi)

Setting of the programmed start/stop timer

3- Press  to access the weekly timer functions.

4- Touch the display inside the graphic area to set the weekly automatic start time for the dryer. The programmed time is highlighted by colouring the graphic area in blue or green.

Light blue area = Programmed time and timer disabled

Green colour area = Programmed time and timer enabled

5- Select/unselect the box to exclude/include the desired day or days of the week in the programming.

6- Select/unselect the box to enable or disable the weekly timer.

7- Press  to return to the previous screens.

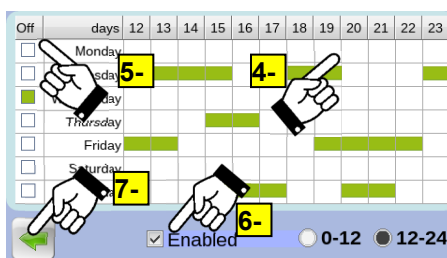
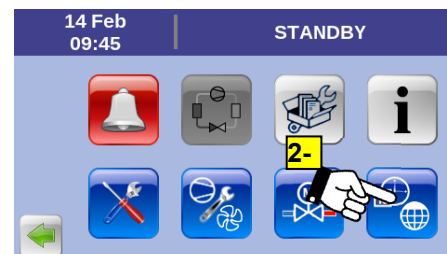
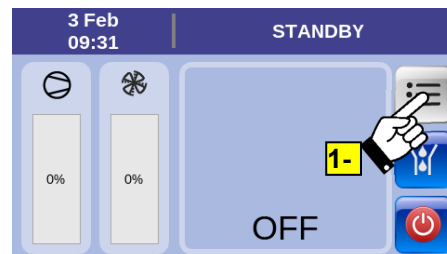

11.17 Electronically level-controlled BEKOMAT condensate drain

The electronically level-controlled BEKOMAT condensate drain is provided with a special condensate management which ensures that condensate is discharged safely and without an unnecessary loss of compressed air. This drain has a condensate collection container in which a capacitive sensor continuously monitors the liquid level. As soon as the switching level is reached, the capacitive sensor transmits a signal to the electronic control and a membrane solenoid valve opens to discharge the condensate. The BEKOMAT closes before compressed air emerges.



Note!

These BEKOMAT condensate drains were designed in particular for the operation in a **DRYPOINT RA VSD** refrigeration dryer. The installation in other compressed-air processing systems or the replacement with another drain brand can lead to malfunction. The maximum operating pressure (see name plate) must not be exceeded!

Ensure that the upstream valve is open when the dryer starts operation.

To obtain detailed information regarding drain functions, troubleshooting, maintenance and spare parts, please read the installation and operating instructions of the BEKOMAT condensate drain.

12 Maintenance, troubleshooting, spare parts and dismantling

12.1 Checks and maintenance



Certified skilled personnel

Installation works must exclusively be carried out by authorised and qualified skilled personnel. Prior to undertaking any measures on the compressed-air refrigeration dryer, the certified skilled personnel³ shall read up on the device by carefully studying the operating instructions. The operator is responsible for the adherence to these provisions. The respective directives in force apply to the qualification and expertise of the certified skilled personnel.

For safe operation, the device must only be installed and operated in accordance with the indications in the operating instructions. In addition, the national and operational statutory provisions and safety regulations, as well as the accident prevention regulations required for the respective case of application, need to be observed during employment. This applies accordingly when accessories are used

Danger!

Compressed air!

Risk of serious injury or death through contact with quickly or suddenly escaping compressed air or through bursting and/or unsecured plant components.

Compressed air is a highly dangerous energy source. Never work on the dryer when the system is under pressure. Never direct the compressed-air outlet or condensate drain hoses at persons. The user is responsible for the proper maintenance of the dryer. Non-observance of the instructions in the "Installation" and "Maintenance, troubleshooting, spare parts and dismantling" chapters leads to the expiration of the guarantee. Improper maintenance may result in dangerous situations for the personnel and/or the device.



Danger!

Supply voltage!

Contact with non-insulated parts carrying supply voltage involves the risk of an electric shock resulting in injuries and death.

Only qualified and skilled personnel are authorised to run electrically-operated devices. Prior to undertaking maintenance measures at the device, the following requirements must be met:

Make sure that the power supply is switched off and that the device is off and marked for maintenance measures. Please also ensure that the power supply cannot be re-established during the works.



Prior to carrying out maintenance works at the dryer, switch it off main switch (control panel pos.1) and wait for at least 30 minutes.

Caution!

Hot surfaces!

During operation, several components can reach surface temperatures of more than +60°C. There is the risk of burns.

All components concerned are installed inside of the closed housing. The housing must only be opened by certified skilled personnel.

Some components can reach high temperatures during operation. Avoid any contact until the system or the component has cooled down.



³ Certified skilled personnel are persons who are authorised by the manufacturer, with experience and technical training, who are well-grounded in the respective provisions and laws and capable of carrying out the required works and of identifying and avoiding any risks during the machine transport, installation, operation and maintenance. Qualified and authorised operators are persons who are instructed by the manufacturer regarding the handling of the refrigeration system, with experience and technical training, and who are well-grounded in the respective provisions and laws.



DAILY:

- Check whether the dew point indicated on the electronics is correct.
- Ensure that the condensate drain system functions properly.
- Make sure that the condenser is clean.

EVERY 200 HOURS OR MONTHLY



- Clean the condenser using an air jet (max. 2 bar / 30 psig) inside out. Make sure not to damage the aluminium lamellae of the cooling package.
- Remove the filter of the electrical panel and clean the filter material with a jet of compressed air. If necessary replace the filter material
- Finally, verify the operation of the device.



EVERY 1,000 HOURS OR ANNUALLY

- Verify all screws, clamps and connections of the electric system to make sure that they are fastened securely. Check the device for broken and ruptured cables or cables without insulation.
- Check the refrigeration cycle for signs of oil and refrigerant leaks.
- Measure the current strength and note it down. Ensure that the read values are within the permissible limit values, as indicated in the specification table.
- Check the hose lines of the condensate drain and replace them, if required.
- Finally, verify the operation of the device.



EVERY 8,000 HOURS

- Replace BEKOMAT(S) Service Unit(s)

12.2 Troubleshooting



Certified skilled personnel

Installation works must exclusively be carried out by authorised and qualified skilled personnel. Prior to undertaking any measures on the compressed-air refrigeration dryer, the certified skilled personnel shall read up on the device by carefully studying the operating instructions. The operator is responsible for the adherence to these provisions. The respective directives in force apply to the qualification and expertise of the certified skilled personnel.

For safe operation, the device must only be installed and operated in accordance with the indications in the operating instructions. In addition, the national and operational statutory provisions and safety regulations, as well as the accident prevention regulations required for the respective case of application, need to be observed during employment. This applies accordingly when accessories are used.



Danger!

Compressed air!

Risk of serious injury or death through contact with quickly or suddenly escaping compressed air or through bursting and/or unsecured plant components.

Compressed air is a highly dangerous energy source.

Never work on the dryer when the system is under pressure.

Never direct the compressed-air outlet or condensate drain hoses at persons.

The user is responsible for the proper maintenance of the dryer. Non-observance of the instructions in the "Installation" and "Maintenance, troubleshooting, spare parts and dismantling" chapters leads to the expiration of the guarantee. Improper maintenance may result in dangerous situations for the personnel and/or the device.



Danger!

Supply voltage!

Contact with non-insulated parts carrying supply voltage involves the risk of an electric shock resulting in injuries and death.

Only qualified and skilled personnel are authorised to run electrically-operated devices. Prior to undertaking maintenance measures at the device, the following requirements must be met:

Make sure that the power supply is switched off and that the device is off and marked for maintenance measures. Please also ensure that the power supply cannot be re-established during the works.



Prior to carrying out maintenance works at the dryer, switch it off main switch (control panel pos.1) and wait for at least 30 minutes.



Caution!

Hot surfaces!

During operation, several components can reach surface temperatures of more than +60°C. There is the risk of burns.

All components concerned are installed inside of the closed housing. The housing must only be opened by certified skilled personnel. Some components can reach high temperatures during operation. Avoid any contact until the system or the component has cooled down.

SYMPTOM	POSSIBLE CAUSE - SUGGESTED ACTION
◆ The dryer is off. The dryer doesn't start	<ul style="list-style-type: none"> ⇒ Check that the system is powered. ⇒ Check the electric wiring. ⇒ Blown fuse (see FU1/FU2/FU3 on the electric diagram) of the auxiliary circuit - replace fuse and check the proper operation of the dryer. ⇒ Dryer is in "REMOTE" mode - see the specific section. ⇒ Dryer is in programmed start/stop mode - see the specific section ⇒ DMC55 electronic controller with alarm operating – see the specific section.
◆ The chiller compressor doesn't work.	<ul style="list-style-type: none"> ⇒ The Dew Point displayed on DMC55 is sufficiently low, so the compressor is not active (only if parameter DCC=YES) – wait that the temperature becomes higher ⇒ Check the electric wiring. ⇒ DMC55 electronic controller with alarm operating – see the specific section. ⇒ Check the compressor remote switch (KC1) or magnetic protection's (QC1) correct operation. ⇒ If the fault persists, replace the compressor.
◆ The fan doesn't work properly (air-cooled).	<ul style="list-style-type: none"> ⇒ The measured condensing pressure (HP) is sufficiently low, so the fan is inactive – wait for the condensation pressure to increase. ⇒ Check the electric wiring. ⇒ DMC55 electronic controller with alarm operating – see the specific section. ⇒ If the fault persists, replace the fan. ⇒ Condensing pressure measured with DMC55 and BHP pressure transducer is incorrect. Please contact a refrigeration engineer to verify and compare the condensing pressure value. If required replace BHP pressure transducer or DMC55 controller.
◆ DewPoint too high.	<ul style="list-style-type: none"> ⇒ The dryer doesn't start - see specific fault. ⇒ The DewPoint probe does not detect the temperature correctly - push the probe until it reaches the bottom of the measuring well. ⇒ Temperature probe BT1 failure - check the electric wiring and/or replace the probe ⇒ The chiller compressor does not work - see specific fault. ⇒ The room temperature is too high or the room air circulation is insufficient - provide proper ventilation (air-cooled). ⇒ The inlet air is too hot - restore nominal conditions. ⇒ The inlet air pressure is too low - restore nominal conditions ⇒ The inlet air flow rate is higher than the dryer's - reduce the flow rate - restore nominal conditions. ⇒ The condenser filter is dirty - clean it (air-cooled) ⇒ The fan does not work - see specific fault (air-cooled). ⇒ The cooling water is too hot - restore nominal conditions (water-cooled) ⇒ The cooling water flow is insufficient - restore nominal conditions (water-cooled). ⇒ The dryer doesn't drain the condensate - see specific fault. ⇒ There is a leak in the chilling circuit - contact a refrigeration engineer. If there is a refrigerant leak, dewpoint could be high, compressor runs at low speed and does not stop even unloaded or with low ambient temperature, the BT3 probe (refrigerant compressor suction) detects a high temperature and low condensing pressure. ⇒ LP evaporating pressure measured with DMC55 and BLP pressure transducer is too high - see specific fault. ⇒ LP evaporating pressure measured with DMC55 and BLP pressure transducer is incorrect. Please contact a refrigeration engineer to verify and compare the evaporating pressure value. If required replace BLP pressure transducer or DMC55 controller ⇒ Condensing pressure measured with DMC55 and BHP pressure transducer is incorrect. Please contact a refrigeration engineer to verify and compare the condensing pressure value. If required replace BHP pressure transducer or DMC55 controller. ⇒ One or more EEV Electronic Expansion Valves do not work properly - see specific fault. ⇒ Check the DPS parameter setting - see the specific section.

SYMPTOM	POSSIBLE CAUSE - SUGGESTED ACTION
◆ DewPoint too low.	<p>NOTE: Slightly negative DewPoint peaks usually occurs with low loads and when refrigerant compressor is in ON/OFF (DCC=YES parameter), cyclic mode.</p> <ul style="list-style-type: none"> ⇒ The fan is always on – check that the BHP (air-cooled) pressure transducer is working properly. ⇒ The room temperature is too low - restore nominal conditions (air-cooled). ⇒ The evaporating pressure measured with DMC55 and BLP pressure transducer is not correct. Please contact a refrigeration engineer to verify and compare the evaporation pressure value. If required replace BLP pressure transducer or DMC55 controller ⇒ Condensing pressure measured with DMC55 and BHP pressure transducer is incorrect. Please contact a refrigeration engineer to verify and compare the condensing pressure value. If required replace BHP pressure transducer or DMC55 controller. ⇒ The BT1 dew point probe does not detect the temperature correctly - check the electrical wiring or replace the probe. ⇒ There is a leak inside the evaporator - contact a refrigeration engineer to carry out an accurate leak search and, if confirmed, replace the exchanger. ⇒ Check the DPS parameter setting - see the specific section.
◆ Excessive pressure drop within the dryer.	<ul style="list-style-type: none"> ⇒ The dryer doesn't drain the condensate - see specific fault. ⇒ The DewPoint is too low - the condensate is frosted and blocks the air - see specific fault. ⇒ The connection hoses are choked - check and resolve ⇒ The heat exchanger is clogged - check the heat exchanger cleaning and pre-filter installation.
◆ The dryer doesn't drain the condensate	<ul style="list-style-type: none"> ⇒ The condensate drain service valve is closed - open it. ⇒ Condensate drain is off - check electrical wiring and FU3 fuse ⇒ The DewPoint is too low - the condensate is frosted - see specific fault. ⇒ The air pressure is too low, and the water is not drained - restore nominal conditions. ⇒ The condensate drain is not working properly - see the specific section.
◆ The dryer continuously drains condensate.	<ul style="list-style-type: none"> ⇒ The condensation drainer is obstructed - see the specific section. ⇒ The condensate drain is faulty - replace the service unit or the whole drain
◆ Water within the line	<ul style="list-style-type: none"> ⇒ Check that the air inlet and outlet connections are correctly connected to the compressed air system (not reversed connection). ⇒ The dryer does not start - see specific fault. ⇒ If installed - Untreated air flows through the by-pass unit - close the by-pass. ⇒ The dryer doesn't drain the condensate - see specific fault. ⇒ DewPoint too high - see specific fault. ⇒ Dryer is undersized
◆ HPS pressure has been activated.	<ul style="list-style-type: none"> ⇒ Check which of the following has caused the activation: <ol style="list-style-type: none"> 1. The room temperature is too high or the room air circulation is insufficient - provide proper ventilation (air-cooled). 2. The condenser filter is dirty - clean it (air-cooled). 3. Compressed air temperature at dryer inlet is too hot - restore nominal conditions. 4. Check HPS pressure switch electrical wiring. 5. The fan does not work - see specific fault (air-cooled). 6. The cooling water is too hot– restore nominal conditions (water-cooled). 7. The cooling water flow is insufficient - restore nominal conditions (water-cooled). ⇒ Reset the pressure switch by pressing the button. Reset the alarm on the electronic controller - check the correct dryer operation. ⇒ Condensing pressure measured with DMC55 and BHP pressure transducer is incorrect. Please contact a refrigeration engineer to verify and compare the condensing pressure value. If required replace BHP pressure transducer or DMC55 controller. ⇒ The HPS pressure switch is faulty - contact a refrigeration engineer for replacement.

SYMPTOM		POSSIBLE CAUSE - SUGGESTED ACTION
◆ Too evaporating pressure.	low	<ul style="list-style-type: none"> ⇒ There is a gas refrigerant leak - contact a refrigeration engineer. ⇒ The evaporating pressure measured with DMC55 and BLP pressure transducer is not correct. Please contact a refrigeration engineer to verify and compare the evaporating pressure value. If required replace BLP pressure transducer and/or DMC55 controller. ⇒ HGBV electronic bypass valve is not working correctly - check the electric wiring of the valve or contact a refrigeration engineer to replace it. ⇒ One or more EEVn Electronic Expansion Valves do not work properly - see specific fault.
◆ Too compressor outlet temperature.	high	<ul style="list-style-type: none"> ⇒ Excessive thermal load – restore operation nominal conditions ⇒ The inlet air is too hot - restore operation nominal conditions. ⇒ The room temperature is too high or the room air circulation is insufficient - provide proper ventilation (air-cooled). ⇒ The condenser filter is dirty - clean it (air-cooled) ⇒ The fan does not work - see specific section (air-cooled). ⇒ There is a gas refrigerant leak - contact a refrigeration engineer. ⇒ One or more EEVn Electronic Expansion Valves do not work properly - see specific fault. ⇒ BT4 temperature probe does not detect the temperature correctly- check the electric wiring or replace the probe ⇒ HGBV electronic bypass valve is not working correctly - check the electric wiring of the valve or contact a refrigeration engineer to replace it.
◆ Too condensing pressure	high	<ul style="list-style-type: none"> ⇒ The room temperature is too high or the room air circulation is insufficient - provide proper ventilation (air-cooled). ⇒ The inlet air is too hot - restore nominal conditions. ⇒ The inlet air flow rate is higher than the dryer's - restore nominal conditions. ⇒ The condenser filter is dirty - clean it (air-cooled). ⇒ BHP pressure transducer faulty - Please contact a refrigeration engineer to verify and compare the condensing pressure value. If they do not match replace the transducer. ⇒ The fan does not work - see specific fault (air-cooled). ⇒ The cooling water temperature is too hot – restore nominal conditions (water-cooled). ⇒ The cooling water flow is insufficient - restore nominal conditions (water-cooled).
◆ Too condensing pressure	low	<ul style="list-style-type: none"> ⇒ The room temperature is too low - restore nominal conditions (air-cooled). ⇒ Air flows through the condenser even with fan off – protect dryer against wind or external air flows (not caused by dryer's fan) (air-cooled). ⇒ The cooling water temperature is too low – restore nominal conditions (water-cooled). ⇒ Cooling water flow control valve needs recalibration - contact a technician to restore nominal setting (water cooled). ⇒ BHP pressure transducer faulty - Please contact a refrigeration engineer to verify and compare the condensing pressure value. If they do not match replace the transducer. ⇒ There is a gas refrigerant leak - contact a refrigeration engineer. ⇒ The fan does not work properly - the speed is too high - see specific fault (air-cooled). ⇒ The compressor doesn't work– see specific section.

SYMPTOM	POSSIBLE CAUSE - SUGGESTED ACTION
<p>◆ Too high evaporating pressure</p>	<ul style="list-style-type: none"> ⇒ Excessive thermal load – restore nominal conditions ⇒ The inlet air is too hot - restore nominal conditions. ⇒ The room temperature is too high or the room air circulation is insufficient - provide proper ventilation (air-cooled). ⇒ The condenser filter is dirty - clean it (air-cooled). ⇒ The fan does not work - see specific fault (air-cooled). ⇒ HGBV electronic bypass valve is not working correctly - check the electric wiring of the valve or contact a refrigeration engineer to replace it. ⇒ Cooling water flow control valve needs recalibration - contact a technician to restore nominal setting (water-cooled). ⇒ The evaporating pressure measured with DMC55 and BLP pressure transducer is not correct. Please contact a refrigeration engineer to verify and compare the evaporating pressure value. If required replace BLP pressure transducer and/or DMC55 controller. ⇒ One or more EEV Electronic Expansion Valves do not work properly - see specific fault. ⇒ The compressor does not work– see specific fault.
<p>◆ Low differential pressure between HP and LP values</p>	<ul style="list-style-type: none"> ⇒ The fan does not work properly - the speed is too high - see specific fault (air-cooled). ⇒ The room temperature is too low - restore nominal conditions. ⇒ Air flows through the condenser even with fan off – protect dryer against wind or external air flows (not caused by dryer’s fan) (air-cooled). ⇒ The cooling water temperature is too low – restore nominal conditions (water-cooled). ⇒ Cooling water flow control valve needs recalibration - contact a technician to restore nominal setting (water cooled). ⇒ HGBV electronic bypass valve is not working correctly - check the electric wiring of the valve or contact a refrigeration engineer to replace it. ⇒ The evaporating pressure measured with DMC55 and BLP pressure transducer is not correct. Please contact a refrigeration engineer to verify and compare the evaporating pressure value. If required replace BLP pressure transducer and/or DMC55 controller. ⇒ Condensing pressure measured with DMC55 and BHP pressure transducer is incorrect. Please contact a refrigeration engineer to verify and compare the condensing pressure value. If required replace BHP pressure transducer or DMC55 controller. ⇒ There is a gas refrigerant leak - contact a refrigeration engineer. ⇒ The compressor does not work - see specific fault.

SYMPTOM	POSSIBLE CAUSE - SUGGESTED ACTION
<p>◆ DMC55 electronic controller with alarm operating (red colour status area)</p>	<p><u>Blinking red status area</u>: one or more alarms are active. The display shows the ID code and the description of the active alarm.</p> <p><u>Steady red status area</u>: one or more alarms need to be cleared. The display shows the ID code and the description of alarm which is no longer active but which still need to be cleared. Refer to the Troubleshooting list above for possible alarm causes and solutions.</p> <p>Refer to the table in section "Alarm condition" to identify the limits of the process values for the following alarm conditions.</p> <ul style="list-style-type: none"> ⇒ A1 - High Pressure Switch: HPS pressure switch triggered (high pressure) due to high refrigerant pressure –see the specific fault. ⇒ A2 - Low Pressure switch: LP evaporating pressure measured with DMC55 and BLP pressure transducer is too low - see specific fault. ⇒ A3 - Low Evaporating Pressure: LP evaporating pressure measured with DMC55 and BLP pressure transducer is too low - see specific fault. ⇒ A4 - High Discharge Temperature: Compressor discharge T4 temperature too high, beyond safety limits - see specific fault ⇒ A5 - Compressor protection: compressor protection QC1 circuit breaker triggered - reset the circuit breaker, restart and check the correct dryer operation ⇒ A6 - Ice: The dew point temperature detected by the BT1 probe is too low - see specific fault (this alarm may trigger when the dryer is stopped). ⇒ A7 - Probe Fault LP: BLP pressure transducer failure ⇒ A8 - Probe Fault HP: BHP pressure transducer failure ⇒ A9 - Probe Fault T1: BT1 temperature probe failure ⇒ A10 - Probe Fault T4: BT4 temperature probe failure ⇒ A11 - Low Differential Pressure: Low differential pressure between HP and LP values - see specific fault ⇒ A12 - High Evaporating Pressure: Evaporating pressure too high - see specific fault ⇒ A13 - Low condensing Pressure - condensing pressure too low - see specific fault ⇒ A15.n - Loosen Fan Control: The operating speed returned by the fan does not correspond to the speed requested by the DMC55 controller. ⇒ A16 - Loosen Comp. Control: The operating speed returned by the compressor does not correspond to the speed required by the DMC55 controller. ⇒ A17 - Pressure Balance Failure: When starting the refrigeration compressor, the LP and HP pressures are not balanced. <ul style="list-style-type: none"> - HGBV electronic bypass valve is not working correctly - check the electric wiring of the valve or contact a refrigeration engineer to replace it. - The evaporating pressure measured with DMC55 and BLP pressure transducer is not correct. Please contact a refrigeration engineer to verify and compare the evaporating pressure value. If required replace BLP pressure transducer or DMC55 controller - Condensing pressure measured with DMC55 and BHP pressure transducer is incorrect. Please contact a refrigeration engineer to verify and compare the condensing pressure value. If required replace BHP pressure transducer and/or DMC55 controller ⇒ A18.n - High SH Valve no.n: The EEVn electronic expansion valve cannot maintain the SH overheating of the evaporator at the setpoint <ul style="list-style-type: none"> - Evaporator excessive thermal load – restore nominal conditions - The BSn temperature probe at the evaporator outlet does not detect the temperature correctly - Check the correct probe positioning and insulation / replace the BSn probe - The evaporating pressure measured with DRVn module and BPN pressure transducer is incorrect. Please contact a refrigeration engineer to verify and compare the evaporating pressure value. If required replace Bpn pressure transducer or DRVn module - One or more electronic expansion valves EEV do not work correctly - see section "Electronic expansion valve process values" - check the electrical wiring of the valve or contact refrigeration engineer for replacement - There is a gas refrigerant leak - contact a refrigeration engineer. ⇒ A E 1001 - Power unit comm. lost: Communication interrupted between the DMC55 power and display modules - Check the wiring or replace the cable (J12 connector). ⇒ A KD 1001 - Variable Speed Drive comm. lost: Interrupted communication between DMC55 power module and the chiller compressor INV1 drive <ul style="list-style-type: none"> - INV1 drive not powered - check that compressor KC1 remote switch or QC1 circuit breaker are working correctly / are active. Check the drive correct wiring - Interrupted cable data connection - check the cable connection between the two modules or replace the cable (M15 connector). - INV1 drive failure - replace the drive

- ⇒ **A FD 1001 - Fan Drive comm. lost:** Interrupted communication between DMC55 power module and the fan INV2 drive
 - INV2 drive not powered - check that the QV1 circuit breaker is working correctly / is active. Check the drive correct wiring.
 - Interrupted cable data connection - check the cable connection between the two modules or replace the cable (M15 connector).
 - INV2 drive failure - Replace the drive
- ⇒ **A Vn 1001 - Valve no.n Comm. Lost:** Interrupted communication between DMC55 power module and the DRVn module
 - DRVn module not powered - check the correct wiring of the module and the FU3 fuse status
 - Interrupted cable data connection - check the cable connection between the two modules or replace the cable (M17 connector).
 - AL1 power supply failure - replace the AL1 power supply
 - DRVn module failure - Replace the module

A KD 000...131 - [text]: Refrigeration compressor INV1 drive alarms - Consult the drive manual for further information.

To reset the alarm: with the alarm active (red flashing status area), switch off the power supply to the dryer using the main switch, wait at least 60 seconds and then restore the power supply. The status area turns steady red, and the alarm can now be reset.

- ⇒ **A KD 001 - Pwr. Card Temp_AL-069:** The temperature sensor on the power board exceeds the upper or lower limits.
 - The room temperature is too high or too low - restore nominal conditions.
 - Obstruction in the cooling air flow
 - Dirt or dust in the heat sink
 - Excessive compressor load
 - Drive cooling fan failure – replace the drive
 - Check the electrical box filter cleaning.
 - Check the setting and electrical wiring of the HT thermostat - Replace thermostat if necessary
 - Electrical box MCP fan failure - replace the fan
- ⇒ **A KD 002 - Earth Fault_AL-014:** Discharge from output phases to ground
 - Check and correct the ground fault of the cables between the drive and the compressor.
 - Check the power supply line
- ⇒ **A KD 004 - Ctrl. World TO_AL-017:** No communication with DMC55 controller
 - Check the cable connection between the two modules or replace the cable (M15 connector)
 - Drive failure - replace the drive
 - DMC55 power module failure - replace the module
- ⇒ **A KD 005 - Over Current_AL-013:** Output current limit exceeded.
 - Check the compressor cable and electrical connections
 - Low input voltage to the drive - Check that the supply voltage is within tolerance limits
 - Power supply voltage drop
 - Dryer overloaded - Restore nominal conditions
 - Compressor failure - Replace
 - Drive failure - Replace
- ⇒ **A KD 008 - Motor ETR Over_AL-010:** Compressor overheated due to load exceeding 100% for too long
 - Excessive thermal load – restore nominal conditions
 - Compressor failure - Replace
- ⇒ **A KD 009 - Inverter Overloaded_AL-009:** Load over 100% for too long
 - Excessive thermal load – restore nominal conditions
 - Compressor failure - Replace
- ⇒ **A KD 010 - DC undervolt AL-008:** DC link voltage falls below the "minimum voltage alarm" limit.
 - No power supply phase at input
 - Fuse blown
 - Undervoltage on the supply network
- ⇒ **A KD 011 - DC overvolt AL-007:** DC link voltage falls below the "minimum voltage alarm" limit.
 - Check static or transient overvoltage on the input power supply.
- ⇒ **A KD 012 - Short Circuit_AL-016:** Short-circuit on compressor or compressor terminals / connections
 - Check and correct short-circuit on drive - compressor connection cables
- ⇒ **A KD 014 - Mains Phase Loss_AL-004:** Missing input power phase or voltage imbalance

- too high
- Check supply voltage
- ⇒ **A KD 017 - Internal Fault AL-038:** Drive failure - Replace
- ⇒ **A KD 019 - U phase Loss AL-30:** Motor phase U missing - Check phase
- ⇒ **A KD 020 - V phase Loss AL-31:** Motor phase V missing - Check phase
- ⇒ **A KD 021 - W phase Loss AL-32:** Motor phase W missing - Check phase
- ⇒ **A KD 023 - 24 V Supply Low AL-047:** 24 V DC may be overloaded
- Drive failure - Replace
- ⇒ **A KD 024 - Mains Failure AL-036:** Drive power supply failure
- Check supply voltage
- Replace drive
- ⇒ **A KD 028 - Earth Fault AL-044:** Discharge from output phases to ground
- Check and correct the ground fault of the cables between the drive and the compressor.
- Check the power supply line
- ⇒ **A KD 029 - Drive Initialised AL-080:** Drive parameters have been deleted
- Contact the dealer to reset the factory parameters
- ⇒ **A KD 100 - Gate Drive Voltage Fault AL-046:** Low control voltage
- Check the power supply line
- Check and correct wiring
- Drive failure - replace the drive
- ⇒ **A KD 125 - Current Limit AL-059:** Current is higher than the maximum allowed value
- Excessive thermal load – restore nominal conditions
- Low input voltage to the drive - Check that the supply voltage is within tolerance limits
- Compressor failure - Replace
- ⇒ **A KD nnn - [non included in the list]:** Compressor Inverter Alarm
- Drive failure - replace the drive

A FD 000...131 - [text]: Fan (air-cooled) INV2 drive alarms - See drive manual for further information.

To reset the alarm: with the alarm active (red flashing status area), switch off the power supply to the dryer using the main switch, wait at least 60 seconds and then restore the power supply. The status area turns steady red and the alarm can now be reset

- ⇒ **A FD 001 - Power board over temp AL-029:** The shutdown temperature of the heat sink has been reached.
- The room temperature is too high - restore nominal conditions.
- Obstruction in the cooling air flow
- Dirt or dust in the heat sink
- Excessive motor load
- Cooling fan failure – replace the drive
- Check the electrical box filter cleaning.
- Electrical box MCP fan failure - replace the fan
- ⇒ **A FD 002 - Earth Fault AL-014:** Discharge from output phases to ground
- Check and correct the ground fault of the cables between the drive and the compressor.
- Check the power supply line
- ⇒ **A FD 004 - Ctrl. World TO AL-017:** No communication with DMC55 controller
- Check the cable connection between the two modules or replace the cable (M15 connector)
- Drive failure - replace the drive
- DMC55 power module failure - replace the module
- ⇒ **A FD 005 - Over Current AL-013:** Output current limit exceeded.
- Check the fan cable and electrical connections
- Low input voltage to the drive - Check that the supply voltage is within tolerance limits
- Power supply voltage drop
- The condenser filter is dirty - clean it
- Drive failure - replace the drive
- ⇒ **A FD 007 - Motor thermistor over temperature AL-011:** The thermistor, or the thermistor connection, is disconnected.
- Check and correct the internal thermal protection of the fan motor and their connection to the fan driver. Wait 30 minutes, restart and check the correct dryer operation
- ⇒ **A FD 008 - Motor ETR over temperature AL-010:** Motor overheated due to load exceeding 100% for too long
- Wait 30 minutes, restart and check the correct dryer operation
- ⇒ **A FD 009 - Fan driver overloaded AL-009:** More than 100% load for too long
- the room temperature is too high - restore nominal conditions.
- condenser cleaning or any obstruction to the fan ventilation (condenser ducting is not permitted).

Maintenance, troubleshooting, spare parts and dismantling

- the fan motor current consumption is higher than nominal - check the correct fan motor operation
- ⇒ **A FD 010 - DC under voltage_AL-008:** DC link voltage falls below the "undervoltage alarm" limit.
- missing phase in the input power supply.
- Fuse blown.
- Low voltage on the power supply
- ⇒ **A FD 011 - DC over voltage_AL-007:** DC link voltage exceeds the limit
- Check static or transient overvoltage on the input supply. Restore it to the correct operating limits
- ⇒ **A FD 012 - Short Circuit_AL-016:** Short circuit in motor or on motor terminals/connections
- Check and correct short circuit on motor connections or motor-fan connections
- ⇒ **A FD 014 - Mains phase loss_AL-004:** Missing phase on supply side or voltage imbalance too high
- Check supply voltage
- ⇒ **A FD 015 - AMA Not OK AL-051...055:** Drive parameters tampered with
- Contact the dealer to reset the factory parameters
- Drive failure - Replace
- ⇒ **A FD 016 - Live Zero Error_AL-002:** Fan drive failure - replace the drive
- ⇒ **A FD 017 - Internal Fault_AL-038:** Fan drive failure - replace the drive
- ⇒ **A FD 019 - Motor phase U missing_AL-030:** Motor U phase missing. Check the phase
- ⇒ **A FD 020 - Motor phase V missing_AL-031:** Motor V phase missing. Check the phase
- ⇒ **A FD 021 - Motor phase W missing_AL-032:** Motor W phase missing. Check the phase
- ⇒ **A FD 028 - Earth fault_AL-044:** Discharge from output phases to ground
- Check and correct the ground fault of the motor connections or the motor-fan connections
- ⇒ **A FD 029 - Drive Initialised AL-080:** Drive parameters have been deleted
- Contact the dealer to reset the factory parameters
- ⇒ **A FD 100 - Control Voltage Fault_AL-047:** 24 V DC may be overloaded
- Check the 24 V DC output cables of the fan driver
- ⇒ **A FD nnn - [non included in the list]:** Fan Inverter Alarm
- Drive failure - replace the drive

Note: "error 85" may appear when trying to access a blocked fan driver function by pressing a display button. This error is not related to a fan malfunction.

A Vn 000...112 - [text]: EEVn electronic expansion valve DRVn drive alarms

- ⇒ **A Vn 006 - Sensor temperature BSn Fault:** BSn Temperature probe failure - check the electric wiring and/or replace the temperature probe
- ⇒ **A Vn 007 - Pressure Sensor BPn Fault:** BPn pressure transducer failure - check the electric wiring and/or replace the pressure transducer
- ⇒ **A Vn 008 - Power fail:** No power supply to the DRVn drive - check the electrical wiring, check the status of the FU3 fuse or replace the DRVn drive.
- ⇒ **A Vn 108 - Pressure Sensor BPn Fault:** BPn pressure transducer failure - check the electric wiring and/or replace the pressure transducer
- ⇒ **A Vn 110 - Pressure Sensor BPn Fault:** BPn pressure transducer failure - check the electric wiring and/or replace the pressure transducer

SYMPTOM	POSSIBLE CAUSE - SUGGESTED ACTION
<p>◆ Electronic controller DMC55 in fault status (orange colour status area)</p>	<p><u>Blinking orange status area</u>: one or more alarms are active. The touch screen display shows the ID code and description of the active alarm.</p> <p><u>Steady orange status area</u>: one or more alarms need to be cleared. The touch screen display shows the ID code and description of an inactive alarm which needs to be cleared. Refer to the Troubleshooting list above for possible causes and solutions.</p> <p>Refer to the table under the "Fault condition" section to find the process value limits for the following faults.</p> <ul style="list-style-type: none"> ⇒ W1 - Low Dew Point: Dew Point T1 temperature too low - see specific fault ⇒ W2 - High Dew Point: Dew point T1 temperature too high (higher than the value set in parameter HdA) - see specific fault ⇒ W3 - Probe Fault T2: BT2 temperature probe failure - check the electric wiring or replace the probe. ⇒ W4 - Probe Fault T3: BT3 temperature probe failure - check the electric wiring or replace the probe. ⇒ W5 - Drainer: ELdN condensate drain does not work properly (ALARM contact open) - see specific fault. This fault could occur with dryer running but without compressed air flow. ⇒ W6 - Programmed Service: Maintenance warning time expired (exceeding the value set in parameter SrV) - carry out the programmed maintenance and reset the hour counter ⇒ W7 - High Discharge Temperature: Compressor discharge T4 temperature too high, but within the safety limits - see specific fault ⇒ W8 - High Evaporating Pressure: Evaporating pressure too high - see specific fault ⇒ W9 - Low Condensing Pressure: Condensing pressure too low - see specific fault ⇒ W10 - High Condensing Pressure: Condensing pressure too high - see specific fault ⇒ W11 - Low ambient temperature: Room temperature detected by BT5 probe too low - restore nominal conditions or replace the probe. ⇒ W12 - High ambient temperature: Room temperature detected by BT5 probe too high - restore nominal conditions or replace the probe ⇒ W13 - Probe Fault T5: BT5 temperature probe failure - check the electric wiring and/or replace the probe ⇒ W14 - Low inlet temperature: Compressed air inlet temperature detected by BT2 probe too low - restore nominal conditions or replace the probe ⇒ W15 - High inlet temperature: Compressed air inlet temperature detected by BT2 probe too high - restore nominal conditions or replace the probe

Maintenance, troubleshooting, spare parts and dismantling

12.3 Spare parts

Spare parts list is printed on a dedicated sticker applied inside the dryer. On this sticker each spare part is identified with its ID Number and related Spare Part Number. Here below the cross reference table between ID Numbers and exploded drawings Ref. with their description and quantity installed in the dryers.

NOTE: To order the recommended spare parts or other elements, the data on the name plate must be indicated.

ID N.	DESCRIPTION	RA VSD						
		800	1000	1250	1500	1750	2000	2500
1 - 1.1	Heat exchanger replacement kit	1	1	1	2	2	2	2
4	HPS Pressure switch	1	1	1	1	1	1	1
6	MC1 Compressor	1	1	1	1	1	1	1
6,1	RC Compressor crankcase heater	1	1	1	1	1	1	1
8	Condenser	1	1	1	2	2	2	2
9	MF1 Complete fan	1	1	1	2	2	2	2
10	Filter drier	1	1	1	1	1	1	1
12	BTn Temperature probe	5	5	5	5	5	5	5
13	Condensate drain valve	1	1	1	2	2	2	2
21	ELD Electronic drainer	1	1	1	2	2	2	2
21,1	Service unit for electronic drainer	1	1	1	2	2	2	2
35	EEVn Electronic expansion valve	1	1	1	2	2	2	2
35,1	Coil for electronic expansion valve	1	1	1	2	2	2	2
37	BHP Pressure transducer	1	1	1	1	1	1	1
39	BLP Pressure transducer	1	1	1	1	1	1	1
44	Suction strainer	1	1	1	1	1	1	1
67	Electrical panel filter	1	1	1	1	1	1	1
78	EHGBV Hot gas by-pass valve	1	1	1	1	1	1	1
78,1	EHGBV Coil for hot gas by-pass valve	1	1	1	1	1	1	1
82	Check valve	1	1	1	1	1	1	1
86	BSn Temperature probe	1	1	1	2	2	2	2
87	BPn Pressure transducer	1	1	1	2	2	2	2
60	QS Main switch	1	1	1	1	1	1	1
	A1 Power module	1	1	1	1	1	1	1
	A2 Touch screen module	1	1	1	1	1	1	1
	A1.1 Power cable - power module to display	1	1	1	1	1	1	1
	AL1 Power supply 24Vdc	1	1	1	1	1	1	1
	INV1 Compressor inverter	1	1	1	1	1	1	1
	INV2 Condenser fan inverter (air cooled only)	1	1	1	1	1	1	1
	INV2D Operating panel for INV2	1	1	1	1	1	1	1
	MCP Electrical panel fan	1	1	1	1	1	1	1
	DRVn EEV controller	1	1	1	2	2	2	2
	QC1 Circuit breaker	1	1	1	1	1	1	1
	QV1	1	1	1	1	1	1	1
	KC1 Contactor	1	1	1	1	1	1	1
	KDR Relay				1	1	1	1
	TF Transformer	1	1	1	1	1	1	1
HT Thermostat	1	1	1	1	1	1	1	

12.4 Maintenance operation on the refrigeration circuit



Caution! Refrigerant!

Maintenance and repair works at refrigeration systems must only be carried out by certified refrigerating engineers only in accordance with the local provisions.

The total amount of refrigerant in the system must be collected for recycling purposes, resource recovery or disposal.

The refrigerant must not be discharged into the environment.

When delivered, the dryer is ready to operate and filled with a refrigerant of the R134a or R407C type.



Should you detect a refrigerant leak, please contact a certified refrigerating engineer. Prior to any intervention, the room needs to be ventilated.

When the refrigeration cycle needs to be refilled, please also contact a certified refrigerating engineer.

You will find the refrigerant type and amount on the name plate of the dryer.

Characteristics of refrigerants used:

Refrigerant	Chemical formula	TLV	GWP
R134a - HFC	CH ₂ FCF ₃	1000 ppm	1430
R407C - HFC	R32/125/134a (23/25/52) CHF ₂ CF ₃ /CH ₂ F ₂ /CH ₂ FCF ₃	1000 ppm	1773.85

12.5 Dismantling of the dryer

When the dryer is dismantled, all parts and operating materials related to the plant need to be disposed of separately.



Part	Material
Refrigerant fluid	R134a, R407C, Oil
Canopy and Supports	Carbon steel, Epoxy paint
Refrigerating compressor	Steel, Copper, Aluminium, Oil
Alu-Dry Module	Aluminium
Condenser Unit	Aluminium, Copper, Carbon steel
Pipe	Copper
Fan	Aluminium, Copper, Steel
Valve	Brass, Steel
Electronic Level Drain	PVC, Aluminium, Steel
Insulation Material	Synthetic rubber without CFC, Polystyrene, Polyurethane
Electric cable	Copper, PVC
Electric Parts	PVC, Copper, Brass



We recommend to comply with the safety rules in force for the disposal of each type of material.

Refrigerant contains droplets of lubrication oil released by the refrigerating compressor.

Do not dispose this fluid in the environment. It has to be discharged from the dryer with a suitable device and then delivered to a collection centre where it will be processed to make it reusable.

13 Attachments

Exploded views – List of components

1	Alu-Dry module	42	Electrical panel fan
1.1	Insulation material	43	Oil separator
4	Refrigerant pressure switch HPS	44	Electrical panel filter
6	Compressor	51	Front panel
8	Condenser (Air-Cooled)	52	Back panel
9	Condenser fan (Air-Cooled)	53	Right lateral panel
10	Filter dryer	54	Left lateral panel
12	BT1 temperature probe (dew point)	55	Cover
13	Condensate drain service valve	56	Base plate
17	Electronic instrument	57	Upper plate
18	Condenser (Water-Cooled)	58	Support beam
19	Condenser water-regulating valve (Water-Cooled)	59	Support bracket
20	Refrigerant accumulator	60	Control panel
21	BEKOMAT	65	Condenser filter
22	Main switch	66	Control panel door
34	Liquid sight glass	67	Compressor suction strainer
35	Electronic Expansion Valve EEV	78	Electronic by-pass valve EHGBV
36	Liquid separator	82	Check valve CHV
37	Refrigerant pressure transducer BHP	83	Refrigerant service valve – H.P. side
39	Refrigerant pressure transducer BLP	84	Refrigerant service valve – L.P. side
40	Compressor variable speed drive INV1	86	EEV temperature sensor BS
41	Condenser fan variable speed drive INV2	87	EEV pressure transducer BP

Electric diagrams – List of components

MC1	Compressor	HPS	High pressure switch
RC	Compressor crankcase heater	EHGBV	Electronic by-pass valve
MFn	Condensers fans	EEVn	Electronic Expansion Valve
A1	DMC55 – Power module	BSn	EEV temperature sensor
A2	DMC55 – Display module	BPn	EEV pressure transduce
INV1	Compressor variable speed drive	DRVn	EEV controller
INV2	Condenser fan drive	ELDn	BEKOMAT
BTn	Temperature probes	QS	Main switch
BHP	Refrigerant High pressure transducer	HT	Electrical panel fan thermo switch
BLP	Refrigerant Low pressure transducer		
NT1	Air-Cooled only	NT5	Limit of equipment
NT2	Verify transformer connection according to power supply voltage	NT6	Timed drain output
NT3	Jump if not installed	NT7	Water Cooled only
NT4	Provided and wired by customer		
BN	Brown	OR	Orange
BU	Blue	RD	Red
BK	Black	WH	White
YG	Yellow / Green	WH / BK	White / Black

13.1 Dryers dimensions

13.1.1 DRYPOINT® RA VSD 800-1250

13.1.2 DRYPOINT® RA VSD 1500-2500

13.2 Exploded views

13.2.1 DRYPOINT® RA VSD 800-1250 Air-Cooled

13.2.2 DRYPOINT® RA VSD 800-1250 Water-Cooled

13.2.3 DRYPOINT® RA VSD 1500-2500 Air-Cooled

13.2.4 DRYPOINT® RA VSD 1500-2500 Water-Cooled

13.3 Electric diagrams

13.3.1 DRYPOINT® RA VSD 800-1250

13.3.2 DRYPOINT® RA VSD 1500-1750

13.3.3 DRYPOINT® RA VSD 2000-2500

BEKO TECHNOLOGIES GmbH

Im Taubental 7
 D - 41468 Neuss
 Tel. +49 2131 988 0
 Fax +49 2131 988 900
 info@beko-technologies.com
 service-eu@beko-technologies.com

DE**BEKO TECHNOLOGIES LTD.**

Unit 11-12 Moons Park
 Burnt Meadow Road
 North Moons Moat
 Redditch, Worcs, B98 9PA
 Tel. +44 1527 575 778
 info@beko-technologies.co.uk

GB**BEKO TECHNOLOGIES S.à.r.l.**

Zone Industrielle
 1 Rue des Frères Rémy
 F - 57200 Sarreguemines
 Tél. +33 387 283 800
 info@beko-technologies.fr
 service@beko-technologies.fr

FR**BEKO TECHNOLOGIES B.V.**

Veenen 12
 NL - 4703 RB Roosendaal
 Tel. +31 165 320 300
 benelux@beko-technologies.com
 service-bnl@beko-technologies.com

NL**BEKO TECHNOLOGIES (Shanghai) Co. Ltd.**

Rm.715 Building C, VANTONE Center
 No.333 Suhong Rd.Minhang District
 201106 Shanghai
 Tel. +86 (21) 50815885
 info.cn@beko-technologies.cn
 service1@beko.cn

CN**BEKO TECHNOLOGIES s.r.o.**

Na Pankraci 58
 CZ - 140 00 Praha 4
 Tel. +420 24 14 14 717 /
 +420 24 14 09 333
 info@beko-technologies.cz

CZ**BEKO Tecnológica España S.L.**

Torruella i Urpina 37-42, nave 6
 E - 08758 Cervelló
 Tel. +34 93 632 76 68
 Mobil +34 610 780 639
 info.es@beko-technologies.es

ES**BEKO TECHNOLOGIES LIMITED**

Room 2608B, Skyline Tower,
 No. 39 Wang Kwong Road
 Kwoloon Bay Kwoloon, Hong Kong
 Tel. +852 2321 0192
 Raymond.Low@beko-technologies.com

HK**BEKO TECHNOLOGIES INDIA Pvt. Ltd.**

Plot No.43/1 CIEEP Gandhi Nagar
 Balanagar Hyderabad
 IN - 500 037
 Tel. +91 40 23080275 /
 +91 40 23081107
 Madhusudan.Masur@bekoindia.com
 service@bekoindia.com

IN**BEKO TECHNOLOGIES S.r.l**

Via Peano 86/88
 I - 10040 Leinì (TO)
 Tel. +39 011 4500 576
 Fax +39 0114 500 578
 info.it@beko-technologies.com
 service.it@beko-technologies.com

IT**BEKO TECHNOLOGIES K.K**

KEIHIN THINK Building 8 Floor
 1-1 Minamiatarida-machi
 Kawasaki-ku, Kawasaki-shi
 JP - 210-0855
 Tel. +81 44 328 76 01
 info@beko-technologies.jp

JP**BEKO TECHNOLOGIES Sp. z o.o.**

ul. Pańska 73
 PL - 00-834 Warszawa
 Tel. +48 22 314 75 40
 info.pl@beko-technologies.pl

PL**BEKO TECHNOLOGIES S. de R.L. de C.**

BEKO Technologies, S de R.L. de C.V.
 Blvd. Vito Alessio Robles 4602 Bodega 10
 Zona Industrial
 Saltillo, Coahuila, 25107
 Mexico
 Tel. +52(844) 218-1979
 informacion@beko-technologies.com

MX**BEKO TECHNOLOGIES CORP.**

900 Great Southwest Pkwy SW
 US - Atlanta, GA 30336
 Tel. +1 404 924-6900
 Fax +1 (404) 629-6666
 beko@bekousa.com

USwww.beko-technologies.com

Original operating instructions in English.
 Subject to technical changes / errors excepted.
 DRYPOINT_RA_VSD_800-2500_manual_en_2022_04

74MD0059A5-EN_00