



EN - english

# Installation and operating manual

Intelligent screen saver

## METPOINT® BDL compact



10-089

# 1. Contents

- 1. Safety instructions..... 5**
  - 1.1. Pictograms and symbols.....5
  - 1.2. Signal words according to ISO 3864 and ANSI Z.535.....5
  - 1.3. General safety instructions .....6
- 2. Device features ..... 7**
- 3. Proper use ..... 8**
- 4. Type plate..... 8**
- 5. Storage and transport ..... 9**
- 6. Technical data..... 10**
- 7. Dimensions and mounting..... 12**
- 8. Installation ..... 14**
  - 8.1. Safety instructions.....14
    - 8.1.1. Prevention of electrostatic discharge (ESD).....16
  - 8.2. Notes for installation .....17
    - 8.2.1. Protection class of housing (IP code) .....17
- 9. Terminal assignment and wiring diagram of METPOINT® BDL compact ..... 18**
  - 9.1. Terminal assignment connector "C" (supply voltage) ..... 18
  - 9.2. Terminal assignment connector "A1 – B2" (analog and digital channels)..... 19
  - 9.3. Terminal assignment connector "D" (galv. isolated pulse input / pulse forwarding)..... 19
    - 9.3.1. Basic version (pulse forwarding support)..... 19
    - 9.3.2. Galv. isolated pulse option..... 19
  - 9.4. Terminal assignment connector "E" (RS485 - Modbus) ..... 20
  - 9.5. Terminal assignment connector "A – B" (alarm relay)..... 20
  - 9.6. Connection of BEKO sensors ..... 22
    - 9.6.1. Connection of METPOINT® SD11 / SD21..... 22
      - 9.6.1.1. Analogue - 2-wire, 4 ... 20 mA ..... 22
    - 9.6.2. Connection of METPOINT® SD23..... 23
      - 9.6.2.1. Analogue - 4-wire, 4 ... 20 mA ..... 23
      - 9.6.2.2. Analogue - 4-wire, 0 ... 10 V..... 24
      - 9.6.2.3. Digital - bidirectional RS485 bus system ..... 24
    - 9.6.3. Connection of METPOINT® SP11 / SP21 / SP61..... 25
      - 9.6.3.1. Analogue - 2-wire, 4 ... 20 mA ..... 25
    - 9.6.4. Connection of METPOINT® SP22 / SP62..... 26
      - 9.6.4.1. Analogue - 4-wire, 0 ... 10 V..... 26
      - 9.6.4.2. Analogue - 3-wire, 0 ... 10 V..... 26
    - 9.6.5. Connection of METPOINT® SF13 / SF53 ..... 27
      - 9.6.5.1. Digital - bidirectional RS485 bus system ..... 27
      - 9.6.5.2. Analogue - 3-wire, 4 ... 20 mA ..... 28
      - 9.6.5.3. Analogue - galvanically isolated pulse output ..... 28
    - 9.6.6. Connection of METPOINT® FS109 / FS211 ..... 29
      - 9.6.6.1. Digital - SDI interface ..... 29
    - 9.6.7. Connection of OCV compact ..... 30
      - 9.6.7.1. Analogue - 2-wire, 4 ... 20 mA ..... 30
      - 9.6.7.2. Digital - bidirectional RS485 bus system ..... 30
    - 9.6.8. Connection of PC 400 ..... 31
      - 9.6.8.1. Digital - bidirectional RS485 bus system ..... 31

9.6.9. Connection of PT 1000 .....	31
9.6.9.1. Analogue - 4-wire, 0 ... 10 V .....	31
9.7. Connection of further sensors .....	32
9.7.1. Analogue, 0/4 ... 20 mA .....	32
9.7.1.1. Analogue - 2-wire 0/4 ... 20 mA .....	32
9.7.1.2. Analogue - 3-wire 0/4 ... 20 mA .....	32
9.7.1.3. Analogue - 4-wire 0/4 ... 20 mA .....	33
9.7.2. Analogue, 0 ... 1/10/30 V .....	33
9.7.2.1. Analogue - 3-wire, 0 ... 1/10/30 V .....	33
9.7.2.2. Analogue - 4-wire, 0 ... 1/10/30 V .....	34
9.7.3. Digital - SDI interface .....	34
9.7.3.1. Digital - 3-wire SDI-interface .....	34
9.7.3.2. Digital - 4-wire SDI-interface .....	35
9.7.4. Digital - bidirectional RS485 bus system .....	35
9.7.5. Analogue - galvanically isolated pulse sensors .....	36
9.7.6. Resistance sensors .....	37
9.7.6.1. 2-wire resistance sensors .....	37
9.7.6.2. 3-wire resistance sensors .....	37
9.7.6.3. 4-wire resistance sensors .....	38
9.8. Connection of external displays (PLC / ZTL) .....	39
9.8.1. Analogue, 0/4 ... 20 mA .....	39
9.8.1.1. Analogue - 2-wire 0/4 ... 20 mA .....	39
9.8.1.2. Analogue - 3-wire 0/4 ... 20 mA .....	39
9.8.1.3. Analogue - 4-wire 0/4 ... 20 mA .....	40
9.8.2. Digital - SDI interface .....	40
9.8.2.1. Digital - 3-wire SDI-interface .....	40
9.8.2.2. Digital - 4-wire SDI-interface .....	41
9.8.3. Digital - bidirectional RS485 bus system .....	41
<b>10. Connecting the METPOINT® BDL compact with a PC .....</b>	<b>42</b>
<b>11. Operation of METPOINT® BDL compact .....</b>	<b>43</b>
11.1. Home (Main Menu) .....	43
11.1.1. Initialisation .....	43
11.1.2. Home after switching-on .....	44
11.2. Settings .....	44
11.2.1. Password .....	45
11.2.2. Sensor settings .....	45
11.2.2.1. Selecting sensor type (example: BEKO Digital sensor) .....	46
11.2.2.2. Labelling measurements and defining resolution (decimals) .....	48
11.2.2.3. Recording measuring data .....	49
11.2.2.4. Alarm settings .....	49
11.2.2.5. Advanced settings (scaling of analog output) .....	51
11.2.2.6. BEKO Digital dew point sensor .....	52
11.2.2.7. Labelling and configuring text fields .....	53
11.2.2.8. Configuring analog sensors .....	56
11.2.2.9. Type "Pulse" .....	58
11.2.2.10. Type "Modbus" .....	61
11.2.3. Device settings .....	66
11.2.3.1. Language .....	67
11.2.3.2. Date and time .....	67
11.2.3.3. Network settings .....	68
11.2.3.4. Modbus (Slave) .....	69
11.2.3.5. Relay settings .....	70
11.2.3.6. SD card .....	70
11.2.3.7. System .....	71
11.2.3.8. Calibrating touch screen .....	75

11.2.4. Backlight .....	76
11.2.5. Cleaning .....	76
11.2.6. System Status .....	77
11.2.7. Virtual channels (optional) .....	77
11.2.7.1. Activating "virtual channels" option .....	77
11.2.7.2. Virtual channel settings .....	78
11.2.7.3. Selecting sensor type .....	78
11.2.7.4. Configuring virtual values .....	79
11.2.7.5. Resolution of decimal places – labelling and recording data values .....	83
11.2.7.6. Example: calculation of "specific performance" .....	84
11.2.8. Analog total (optional) .....	86
11.2.8.1. Activating "Analog total" option .....	86
11.2.8.2. Selecting sensor type .....	87
11.3. Web server (optional) .....	88
11.3.1. Activating web server option .....	88
11.3.2. User interface .....	89
11.3.2.1. Information .....	89
11.3.2.2. Selecting language .....	90
11.3.3. Login .....	90
11.3.4. Favourites .....	91
11.3.5. Status .....	91
11.3.6. Current value .....	92
11.3.7. Display .....	93
11.3.8. Chart .....	94
11.3.9. AlarmMail .....	95
11.3.10. User .....	96
11.3.11. EMail .....	96
11.4. Data logger settings .....	97
11.5. Charts .....	101
11.5.1. Chart/Real time values .....	104
11.6. Current values .....	107
11.7. Alarm overview .....	108
11.8. Export/Import .....	108
11.9. Screenshot function .....	110
11.9.1. Saving screenshots .....	110
11.9.2. Exporting screenshots .....	110
<b>12. SD card and batteries .....</b>	<b>112</b>
<b>13. Cleaning/decontamination .....</b>	<b>113</b>
<b>14. Dismantling and disposal .....</b>	<b>114</b>
<b>15. Declaration of Conformity .....</b>	<b>116</b>



## 1. Safety instructions

### 1.1. Pictograms and symbols



General hazard symbol (danger, warning, caution)



General instructions



Observe installation and operating instructions (on the type plate)



Observe installation and operating instructions

### 1.2. Signal words according to ISO 3864 and ANSI Z.535

**DANGER**

**Imminent danger**

Consequences of non-compliance: serious or even fatal injury

**WARNING**

**Potential danger**

Consequences of non-compliance: serious or even fatal injury

**CAUTION**

**Imminent danger**

Consequences of non-compliance: injury and/or damage to property

**NOTICE**

**Potential danger**

Consequences of non-compliance: injury and/or damage to property

**IMPORTANT**

**Additional notes, tips and hints**

Consequences of non-compliance: inefficient operation, extra maintenance work; no further risks

### 1.3. General safety instructions

<b>NOTICE</b>	<b>Before reading this manual, make sure that it refers to your device model.</b>
	<p>Before reading this manual, make sure that it refers to your device model. Strictly observe all instructions provided in this operating manual. It provides general information and instructions for the installation, operation and maintenance of your device. Therefore, it is important that the installation technicians and all operators / *specialist technical personnel read these instructions prior to installation, start-up and maintenance. A copy of this installation and operating manual must be kept near the METPOINT® BDL compact where it is at all times accessible to staff. In addition to this installation and operating manual, observe all applicable local and statutory regulations. Ensure that the METPOINT® BDL compact is only operated within the permissible limits as specified on the type plate. Non-compliance might result in injury or damage to property, malfunction or device failure.</p> <p>If you have any queries regarding the content of this installation and operating manual, please contact BEKO TECHNOLOGIES.</p>

<b>WARNING!</b>	<b>Risk of injury to personnel with insufficient qualification!</b>
	<p>Incorrect operation of the device might cause serious injury or damage to property. All tasks described in this operating manual must be performed by skilled technical personnel who meet the criteria outlined below.</p>

<b>CAUTION!</b>	<b>Malfunction of BDL compact</b>
	<p>Incorrect installation or insufficient maintenance can result in malfunction of the BDL, so that the incorrect values are displayed.</p>

<b>DANGER!</b>	<b>Inadmissible operating parameters!</b>
	<p>If the specified limits are exceeded, there is a risk of device malfunction, potentially resulting in injury and/or damage to property.</p>

**Actions:**

- Ensure that the METPOINT® BDL compact is only operated within the permissible limits as specified on the type plate.
- Strictly comply with the performance data of the METPOINT® BDL compact permissible for your application.
- Always adhere to the specified transport and storage temperatures.

**Additional safety instructions:**

- For the installation and operation of the device, always comply with the statutory safety regulations.
- Do not operate the BDL in potentially explosive atmospheres.

**Additional instructions:**

- Prevent overheating of the device!

**\*Skilled technical personnel**

Skilled technical personnel are persons who, due to their professional qualification and knowledge in the field of measuring, control and pneumatic technology, and their knowledge of the applicable statutory regulations, guidelines and standards are in a position to foresee potential dangers in relation to the use of the device and who are qualified to perform the tasks described in this manual.

Special operating conditions (e.g. aggressive media) require additional knowledge.

## 2. Device features

The METPOINT® BDL compact has been developed and designed by engineers who have many years of practical experience in measuring and control technology.

The METPOINT® BDL compact caters for a range of tasks – from measurement recoding, automatic sensor detection and display of measurements on the large colour display, alarm signal output and data storage to remote data access via web server. An alarm message can be sent e-mail through the BEKO web server and the Ethernet connection.

All relevant information is displayed on the 3.5" colour display with an intuitive and barrier-free touch screen. The display shows measurements, curves and limit exceedances. To trace a curve from the start of the measurement, simply follow it with your finger.

The user-friendly setup steps and the evaluation options for measurements are two of the main advantages of the BDL over conventional paperless screen recorders.

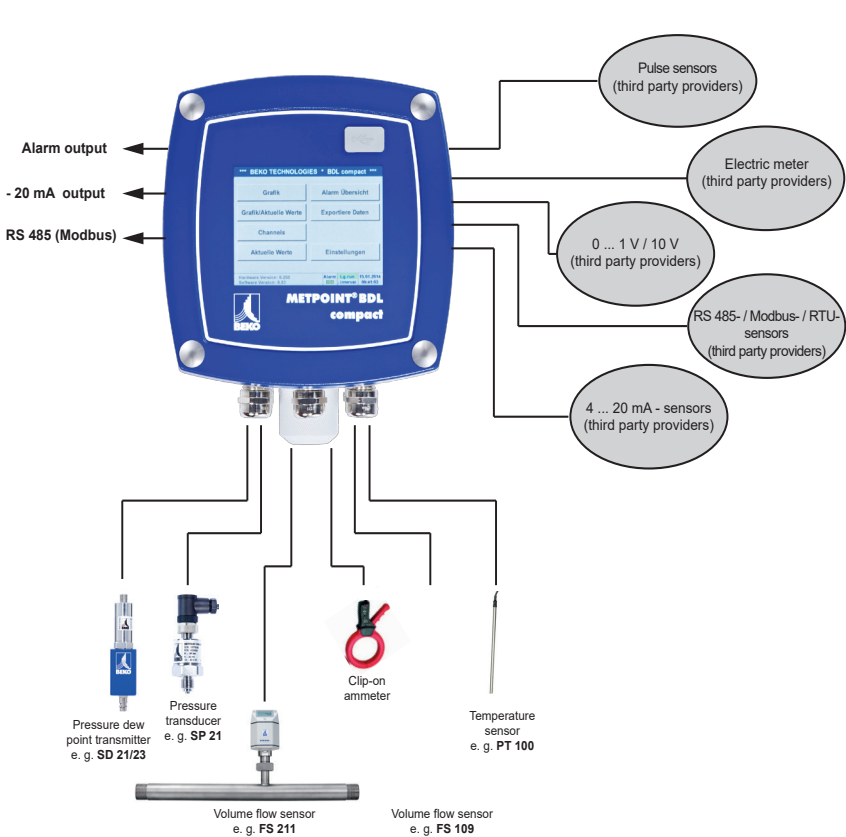

### Multifunctional:

The METPOINT® BDL compact automatically detects up to 4 BEKO sensors with SDI signal (consumption, dew point, pressure, current, KTY, Pt100, Pt1000). Analog sensors (0/4 – 20 mA, 0 – 1/10/30 V, pulse) can be connected and configured in user-friendly menus. Digital sensors can be connected via RS 485, Modbus RTU, and SDI.

### Flexible:

Network-compatible, data transmission via Ethernet, integrated web server.

### Alarm relays/error messages:

Up to 4 limit values can be configured and assigned to 2 different alarm relays. The BDL caters for collective alarms.

### 3. Proper use

The METPOINT® BDL compact data logger has been specifically designed for the stationary measured data acquisition and storage of analog and digital input signals; the device must not be operated in potentially explosive atmospheres.

The METPOINT® BDL compact data logger is exclusively designed and constructed for the proper application purpose that is described herein and must only be used accordingly.

A check in order to ascertain whether or not the device is suitable for the chosen employment must be carried out by the user. The technical data specified in data sheet are binding.

Improper handling or operation of the device outside the technical specifications is not permissible. Claims for compensation for damage caused by improper use are excluded.

### 4. Type plate

The type plate is attached to the device housing. It contains all relevant technical data of the METPOINT® BDL compact data logger. Please have these details to hand when contacting the manufacturer or supplier.

#### METPOINT® BDL compact

Supply Voltage: 100 ... 240 V AC / 1 Ph. / PE  
 Frequency Range: 50 ... 60 Hz  
 Max. Power Input: 25 VA  
 Degree of Protection: IP 44  
 Ambient Temperature: 0 ... +50°C  
 Weight: 2,7 kg

Type: 4027486  
 S/N: 12958791

BEKO TECHNOLOGIES  
[www.beko-technologies.com](http://www.beko-technologies.com)

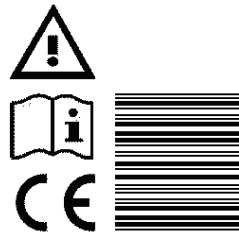



METPOINT® BDL:	Product designation
Supply Voltage:	Supply voltage
Frequency Range:	Frequency range
Max. Power Input:	Max. power consumption
Degree of Protection:	IP class
Ambient Temperature:	Ambient temperature
Weight:	Weight
Type:	Internal product no. (example)
S/N:	Serial no. (example)

NOTICE	Type plate
	Do not remove or cover the type plate, and protect it against damage.

## 5. Storage and transport

Despite our best efforts regarding packaging, etc., the device might be damaged during transport. Upon receipt, please remove all packaging material and inspect the METPOINT® BDL compact for visible damage. If you detect such damage, immediately notify the carrier company and BEKO TECHNOLOGIES or one of its agents.

<b>WARNING!</b>	<b>Overheating</b>
	Overheating can damage the evaluation electronics. Observe the permissible storage, transport and operating temperature (protect measuring device from direct sunlight).

<b>WARNING!</b>	<b>Risk of damage</b>
	Incorrect transport or storage, or the use of unsuitable lifting equipment might cause damage to the METPOINT® BDL compact.

### Preventive measures

- The METPOINT® BDL compact must only be transported and stored by authorised and suitably \*skilled technical personnel.
- To transport the device, use only suitable lifting gear that is in proper working order.
- Always observe the relevant statutory requirements.

<b>CAUTION!</b>	<b>Risks from damaged components!</b>
	If you suspect that the METPOINT® BDL compact is damaged, do not start it. Defective components might impair the operational safety of the METPOINT® BDL compact or result in incorrect measurements and lead to serious damage.

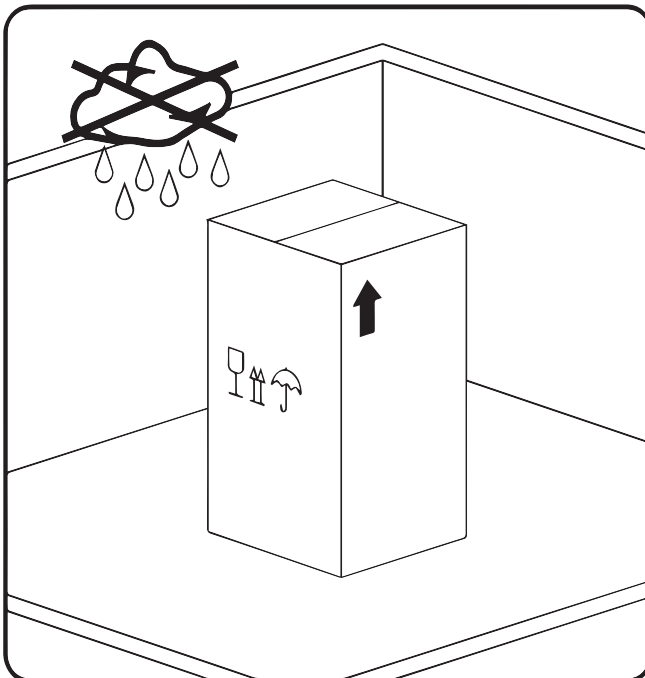

The METPOINT® BDL compact must be stored in the original packaging. Seal the packaging and store it in a dry and frost-free room. Ensure that the storage temperature does not exceed the limits specified on the type plate.

Even when packaged, take suitable measures to protect the METPOINT® BDL against the elements.

While in storage, secure the METPOINT® BDL compact so that it cannot topple over or fall, and protect it against vibration.

### \*Skilled technical personnel

Skilled technical personnel are persons who, due to their professional qualification and knowledge in the field of measuring, control and pneumatic technology, and their knowledge of the applicable statutory regulations, guidelines and standards are in a position to foresee potential dangers in relation to the use of the device and who are qualified to perform the tasks described in this manual.

Special operating conditions (e.g. aggressive media) require additional knowledge.

## 6. Technical data

Colour display	3.5" touch panel, TFT transmissive
Supply voltage <sup>1)</sup>	100 ... 240 V AC 1Ph / PE 50 ... 60 Hz
Power supply line <sup>2)</sup>	Max. cable jacket diameter: 6.7 mm Wire cross-section: 0.75 mm <sup>2</sup> with safety plug and PE conductor
Max. power consumption	25 VA
Supply voltage for sensors	24 V DC ( $\pm 10\%$ )
Output current - analog board	120 mA in total for both channels
Output current - digital board	120 mA in continuous mode / channel
Max. output current through all channels	280 mA
Ambient temperature during operation	0°C ... +50 °C
Storage and transport temperature	-20°C ... +70 °C
Ambient air humidity	0 ... 95 %, no condensation
Protection class <sup>3)</sup>	IP 44, EN 60529
Lithium manganese dioxide battery <sup>4)</sup>	Panasonic CR2032
Connections	7 x cable connection M12x1.5 Body: Brass, nickel-plated Terminal size: 3-7 mm, WS=16 mm Tightening torque: 8 Nm  1x RJ45 for Ethernet connection
Interfaces	USB memory stick (USB 2.0) Ethernet interface, Modbus TCP RS485 interface, Modbus RTU SDI interface (Serial Data Interface)
Sensor inputs	4 (2x2) sensor inputs for analog and digital sensors, free assignment
Sensor signals <sup>5)</sup>	Analog signals: 0 - 1/10/30 V Pulse signals Pt100; Pt1000 Digital signals: RS485, BEKO-SDI
Alarm outputs (alarm relays)	2x floating switchover contacts freely programmable, alarm management
Analog output and pulse output	Looped with sensors with own signal output, e.g. FS / DP series
Data logger	4 GB memory card (micro SDHC class 4)
Housing material	Housing: Powder-coated aluminium Polyester front foil (anti-glare) 3M adhesive (3M7952 / 3M467)
Weight	2.7 kg
Dimensions W x H x D	180 x 166 x 115 mm
Optional	Web server
Optional	Galvanically insulated pulse output (2x) max. 30V AV / 60V DC ; 250mA
Optional	Ethernet and RS485 interface Modbus protocol

- 1) Input voltage range: 85 ... 264 V AC / 47 ... 63 Hz / 1 Ph. / PE
- 2) Mains cable 3 x 0.75 mm<sup>2</sup> with safety plug and PE conductor  
Cable length 2.5 m, cable type H05VV-F 3G0.75  
connection line according to HD21.5, HD21.12 (VDE 0281-5, VDE 0281-12)

The line conforms to Regulation (EC) No. 1907/2006 (REACH) and EC Directive 2002/95/EC (RoHS) as well as the EC Low Voltage Directive 2006/95/EC.

Two-pin plug with PE conductor

Rate voltage for plug: 250 V

Rated current for plug: 16 A

Manufacturing regulation CEE 7 standard sheet VII, VDE 0620

- 3) IP 44 according to EN 60529

IP International Protection

4 Protection against access to hazardous parts with a wire (Ø 1.0 mm).

Protection against access to hazardous parts with foreign objects Ø ≥ 1.0 mm.

4 Protection against splashing water.

- 4) Type: Lithium manganese dioxide battery, Panasonic CR2032  
Rated voltage: 3 V  
Capacitance: 225 mAh  
Max. continuous current: 0,2 mA  
Diameter: 20 mm  
Height: 3,2 mm  
Weight: 2,9 g  
Operating temperature: -30 ... +60 °C

- 5) BEKO sensors

Digital BEKO sensors for pressure dew point and consumption with RS485 interface,  
Series: DPM SD23, FLM SFxx

Digital BEKO sensors for dew point and consumption with SDI interface,  
Series: DP 109, DP 110, FS 109, FS 211

Analogue BEKO sensors preconfigured for pressure, temperature, consumption, current clamp,  
Series: DPM, PRM, FLM

Sensors with analog signals: 0/4 – 20 mA, 0 - 1/10/30 V, pulse, Pt100, Pt1000

CE conformity <sup>1</sup>	
EMC Directive	2004/108/EC
Low voltage directive	2006/95/EC
RoHS II Directive <sup>2</sup>	2011/65/EU
EMC immunity; industrial applications	EN 61326-1 & EN 61326-2-3
EMC emission, group 1, class B	EN 61326-1
Electrical equipment for measurement, control and laboratory use	EN 61010-1

1) CE Mark applied according to Low Voltage Directive 2006/95/EC

2) The terms of Directive 2011/65/EU on the Restriction of the use of certain hazardous substances in electrical and electronic devices are fulfilled.

## 7. Dimensions and mounting

The device can be integrated into a control panel or mounted on a wall, using suitable wall plugs and screws. For details, see drawing below.

### Dimensions for wall mounting

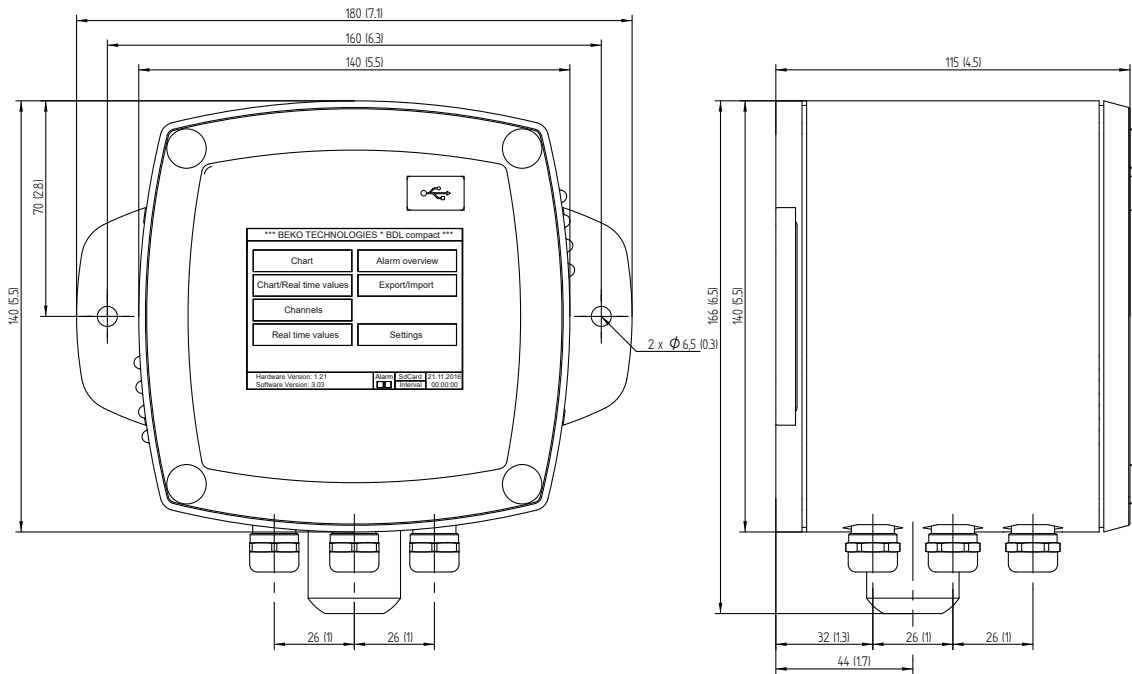

in mm (inch)

<p><b>Notice!</b></p>	<p><b>Wall mounting</b></p>
	<p>For wall mounting, use fixtures that can carry at least 4 times the weight of the device (10.8 kg).</p>



Dimensions for control panel installation

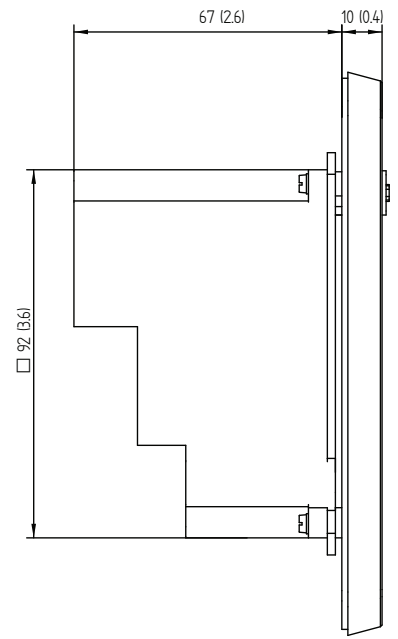
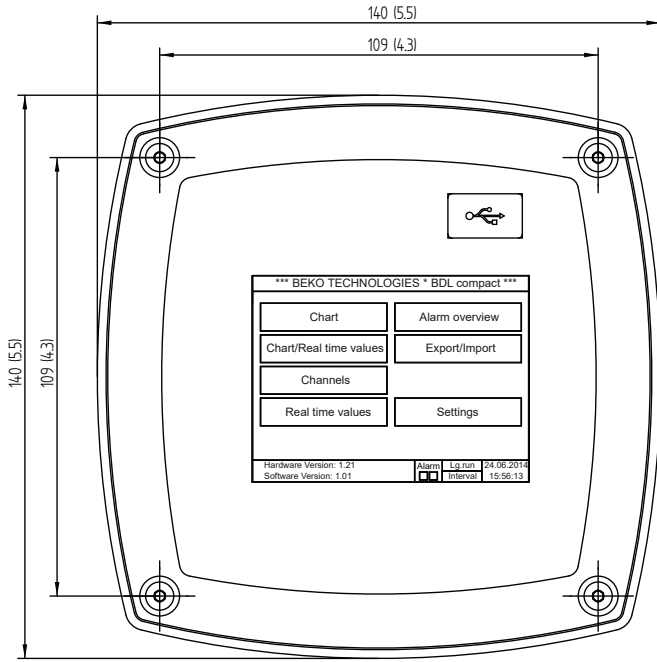

Cut-out for control panel installation

in mm (inch)

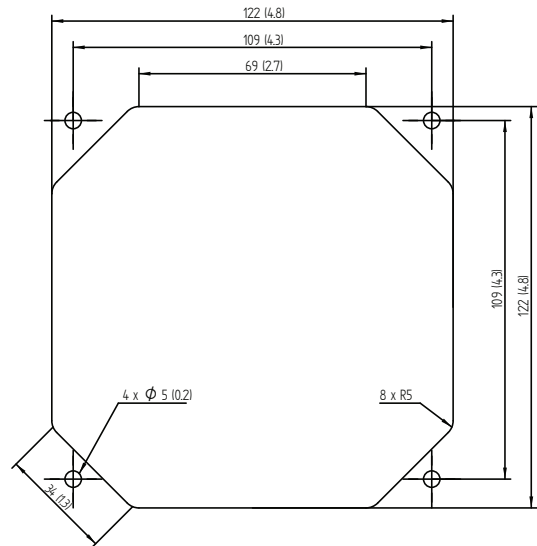
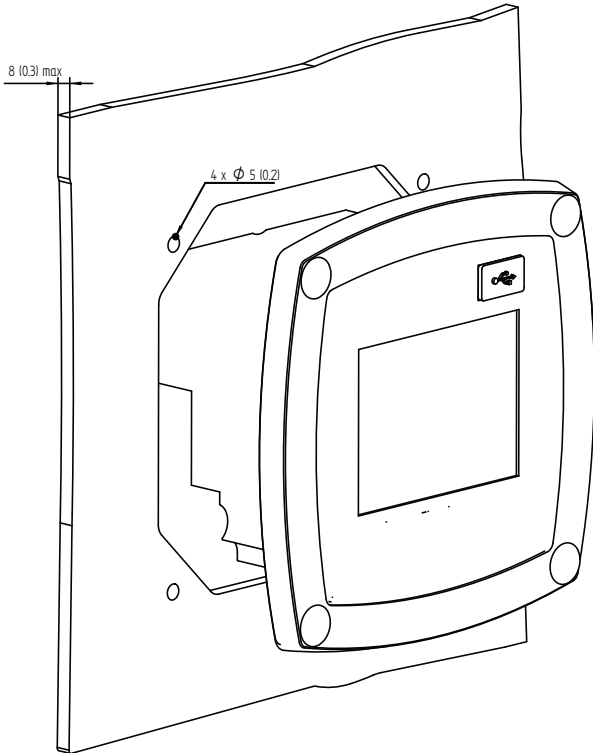

in mm (inch)

## 8. Installation

### 8.1. Safety instructions

<b>DANGER!</b>	<b>Mains voltage</b>
	Risk of serious or even fatal injury from electric shock when coming into contact with non-insulated, powered components.

**Actions:**

- For the electrical installation of the device, adhere to all applicable regulations (e.g. VDE 0100).
- All electrical work must only be carried out by authorised and \*skilled technical personnel.
- For the connection of the power mains and the installation of suitable safety devices, strictly adhere to all statutory regulations that apply at the location of installation of the METPOINT® BDL compact. The connection must be established by suitably skilled technical personnel.
- Make sure that no parts of the measuring devices are energized and that the measuring devices cannot be connected to the electric supply mains while maintenance work is in progress.

<b>DANGER!</b>	<b>Operation without earth connection!</b>
	If there is a fault but no earth connection (protective earth), conductive components might become energised, posing a risk of serious or even fatal injury. The device must therefore be connected to an earth conductor. Do not use plug adapters at the power plug. If required, have the power plug replaced by a qualified electrician.

<b>DANGER!</b>	<b>Operation without circuit breaker!</b>
	All components that are powered and exposed must be disconnectable by means of dedicated external circuit breakers. The circuit breaker must be installed in the vicinity of the device. The circuit breaker must conform to IEC 60947-1 and IEC 60947-3. The circuit breaker must disconnect all electrical conductors from the mains power supply. The circuit breaker must not be installed in the power supply line. The circuit breaker must at all times be easily accessible to operating personnel.



To disconnect the device from the power mains, pull the plug from the socket. Ensure that the power plug is clearly identified and easily accessible by operating personnel. The plug must conform to CEE7/7.

All electrical cables carrying supply voltage or other dangerous voltage (main supply cable, alarm cable, signalling relays) must be equipped with double or reinforced insulation (EN 61010-1). This can be achieved by using plastic-sheathed cables, a second insulation (e.g. flexible insulating tubing), or cables with reinforced insulation.  
The power cables can for example be protected with flexible insulating tubing. The additional flexible insulating tubing must withstand the electrical and mechanical stresses that are likely to occur in connection with the intended use (see EN 61010-1, section 6.7.2.2.1).

**\*Skilled technical personnel**

Skilled technical personnel are persons who, due to their professional qualification and knowledge in the field of measuring, control and pneumatic technology, and their knowledge of the applicable statutory regulations, guidelines and standards are in a position to foresee potential dangers in relation to the use of the device and who are qualified to perform the tasks described in this manual.

Special operating conditions (e.g. aggressive media) require additional knowledge.

<b>DANGER!</b>	<b>Mains voltage</b>
	When wiring the power supply line, ensure that the double or reinforced insulation between the electric circuits and the secondary circuit remains intact.
<b>NOTICE</b>	<b>Insulation</b>
	The additional insulation must be suitable for a test voltage of 1500 VAC. The thickness of the insulation must be at least 0.4 mm (e.g. insulating tubing, type BI 85 from Bierther GmbH).

The additional insulation of the power cables (mains connection, alarm and signalling relays) can be implemented as follows:

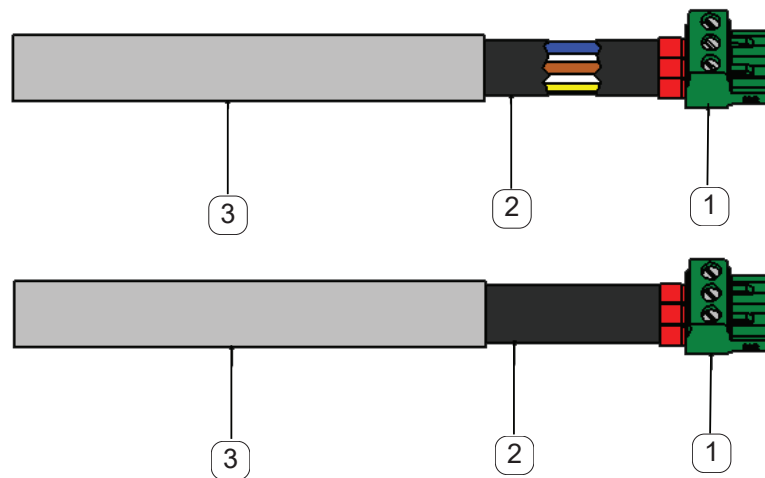

- ① - Terminals (plug-type connectors)
- ② - Flexible insulating tubing for the power cables
- ③ - Connecting cable

### 8.1.1. Prevention of electrostatic discharge (ESD)

DANGER!	Risk of damage from ESD
	<p>The device contains electronic components that might be destroyed by electrostatic discharge (ESD). Avoid contact with persons or objects that are electrically charged. In the worst case, components sensitive to ESD might be instantly destroyed when touched or fail after start-up. In order to minimise or prevent possible damage from sudden electrostatic discharge, observe the requirements of EN 61340-5-1. Do not touch electronic components while they are powered.</p>

#### Basic safety precautions

In order not to cause damage when handling electronic devices, take the necessary precautions for the prevention of electrostatic charges laid down in DIN EN 61340-5-1, IEC 63140-5, and DIN EN 100 015.

These precautions prevent electronic discharge and thus protect your equipment.

#### Preventive measures

When opening the housing of the METPOINT® BDL compact for maintenance or servicing, take the following protective measures:

- Stand on an earthed ESD mat
- Wear a wrist strap
- Discharge tools prior to use by rubbing them over the ESD mat

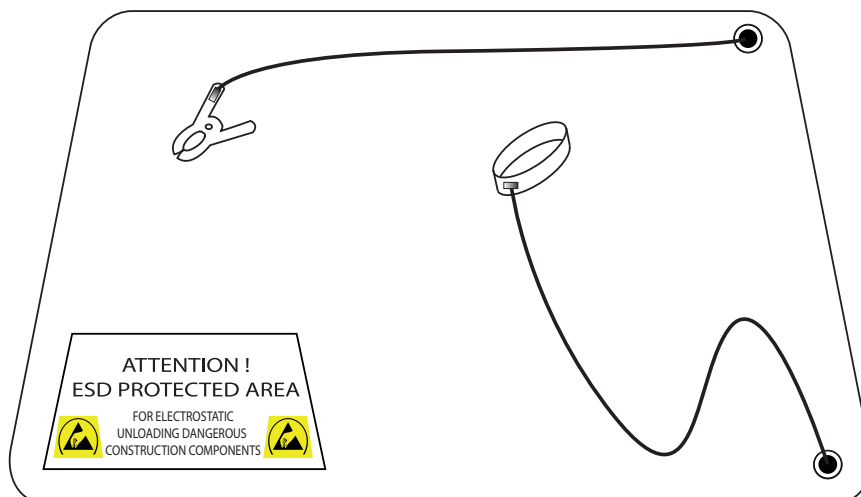

## 8.2. Notes for installation

### 8.2.1. Protection class of housing (IP code)

The METPOINT® BDL compact data logger meets the requirements of protection class IP 44 according to EN 60529.

The protection class of a housing is indicated by the two-digit IP code. The first digit indicates the protection rating with to persons and objects), the second digit indicates the rating for protection against water ingress.

#### IP 44 according to EN 60529

<b>IP</b>	International Protection
<b>4</b>	Protection against access to hazardous parts with a wire ( $\varnothing$ 1.0 mm). Protection against access to hazardous parts with foreign objects $\varnothing \geq 1.0$ mm.
<b>4</b>	Protection against splashing water. Water splashing against the housing must not cause damage to the device.

<b>DANGER!</b>	<b>IP class</b>
	After installation, service and maintenance work, you must ensure that the data logger meets again the requirements of the above protection class.

When performing work on the METPOINT® BDL compact, observe the following:

- Use only original seals. Ensure that all seals are clean and free of defects. Replace defective seals.
- Ensure that the electrical cables are not damaged.
- All cables must meet the relevant standards and regulations.
- Replace defective electrical cables without delay.
- The cable leading to the measuring device must be installed in a loop to prevent water ingress into the housing.
- Tighten all cable ducts.
- Terminals and ducts that are not used must be sealed with dummy plugs.

## 9. Terminal assignment and wiring diagram of METPOINT® BDL compact

Connections at rear of device

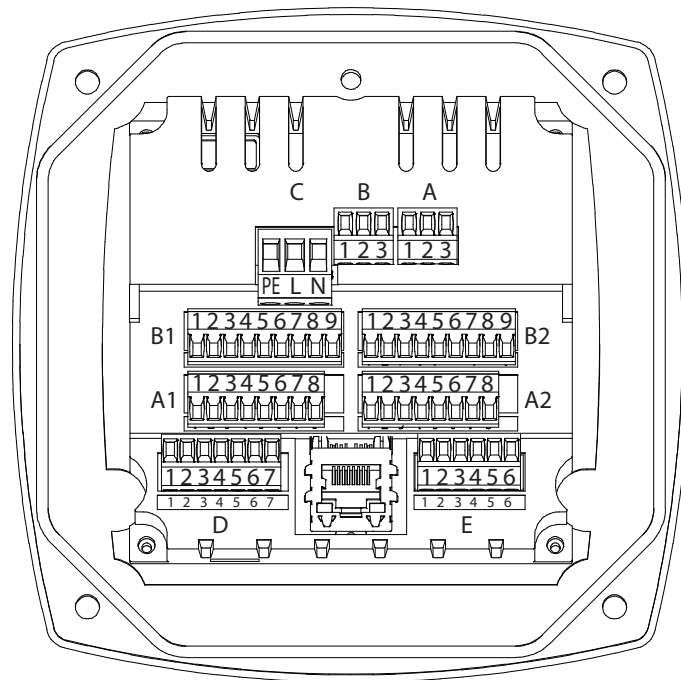









All connections at the rear of the device are designed as pluggable terminal blocks. Instructions for connection:

- Wire cross-section for power mains, plug C: 0.75 - 2.5 mm<sup>2</sup> / AWG12 - AWG24
- Wire cross-section for alarm contacts, plugs A / B: 0.14 - 1.5 mm<sup>2</sup> / AWG16 - AWG28
- Wire cross-section for sensors: 0.14 - 1.5 mm<sup>2</sup> / AWG16 - AWG28

<b>DANGER!</b>	<b>Mains voltage</b>
	Incorrect connection of the device to the power mains can lead to serious or even fatal injury and cause malfunction of the METPOINT® BDL compact.

### 9.1. Terminal assignment connector "C" (supply voltage)

<b>Input voltage range: 85 ... 264 V AC / 47 ... 63 Hz / 1 Ph / PE</b>										
<b>Wire cross-section: 0.75 - 2.5 mm<sup>2</sup> / AWG12 - AWG24</b>										
<table border="1" style="margin: auto;"> <tr> <td style="text-align: center;">1</td> <td style="text-align: center;">2</td> <td style="text-align: center;">3</td> </tr> <tr> <td style="text-align: center;"></td> <td style="text-align: center;"></td> <td style="text-align: center;"></td> </tr> <tr> <td style="text-align: center;">PE</td> <td style="text-align: center;">L</td> <td style="text-align: center;">N</td> </tr> </table> <p style="text-align: center;">C</p>	1	2	3				PE	L	N	<p><b>1 = PE = protective earth conductor</b></p> <p><b>2 = L = phase L</b></p> <p><b>3 = N = neural conductor</b></p>
1	2	3								
										
PE	L	N								

## 9.2. Terminal assignment connector "A1 – B2" (analog and digital channels)

Both boards are equipped with internal bridges

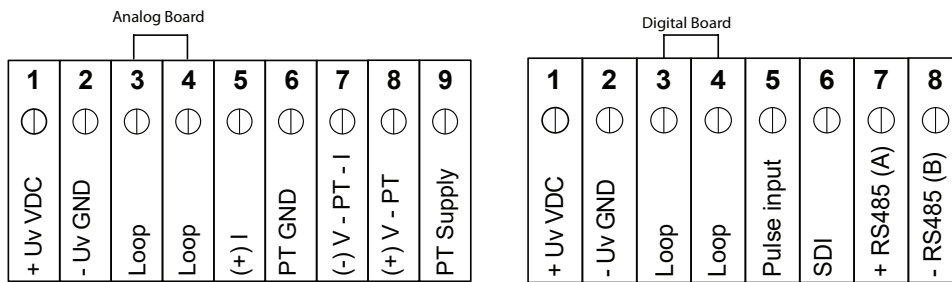

Depending on the selected option, the following combinations are supported:

Channel \ Combination	1	2	3	4	5	6
A1	D	D	D	A	A	A
A2	D	D	D	A	A	A
B1		D	A		A	D
B2		D	A		A	D

D = digital channel A = analog channel

## 9.3. Terminal assignment connector "D" (galv. isolated pulse input / pulse forwarding)

### 9.3.1. Basic version (pulse forwarding support)

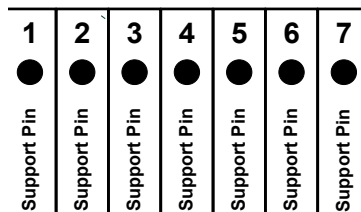

### 9.3.2. Galv. isolated pulse option

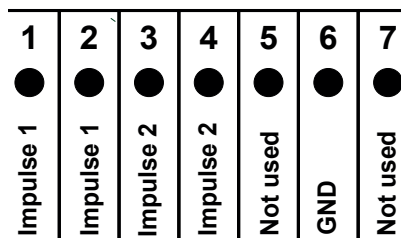

In systems with 2 digital boards (2x2 digital channels), only 1 pulse input can be connected to a pulse output.



A1 or B1 for pulse 1 or A2 or B2 for pulse 2

### 9.4. Terminal assignment connector "E" (RS485 - Modbus)

1	2	3	4	5	6
●	●	●	●	●	●
Common	RS485 (B)	RS485 (A)	Common	RS485 (B)	RS485 (A)

### 9.5. Terminal assignment connector "A – B" (alarm relay)

The alarm outputs are designed as floating switchover contacts. The alarm signal can be forwarded to a control desk, etc. through the floating contacts. The connectors for the alarm contacts are labelled as "A" and "B".

<b>DANGER!</b>	<b>Mains voltage</b>
	When wiring the electric power supply line, ensure that the double or reinforced insulation between the electric circuits and the secondary circuit remains intact.
<b>NOTICE!</b>	<b>Mains voltage</b>
	The additional insulation must be suitable for a test voltage of 1500 VAC. The insulation must be at least 0.4 mm thick e.g. insulation hose, type BIS 85 from Bierther GmbH.

The additional insulation of the power cables (mains connection, alarm and signalling relays) can be implemented as follows:

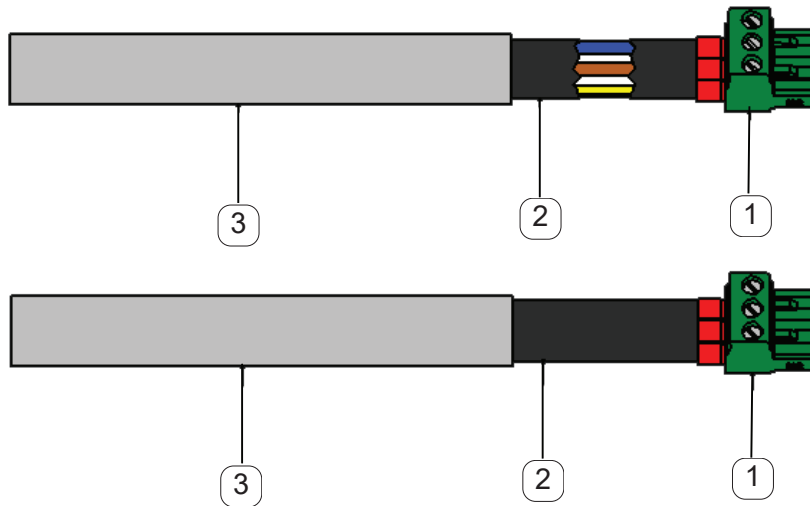

- ① - Terminals (plug-type connectors)
- ② - Flexible insulating tubing for the power cables
- ③ - Connecting cable



Connections at rear of device

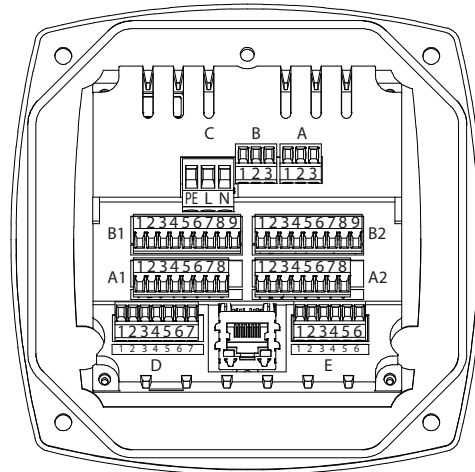

**Floating alarm switchover contacts - connectors A and B**

Wire cross-section: 0,14 - 1,5 mm<sup>2</sup> / AWG16 - AWG28

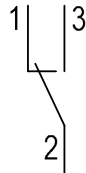
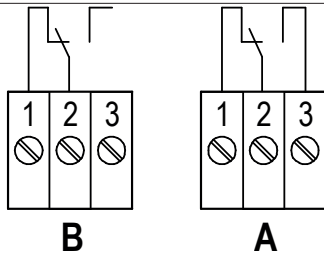

1 = NC = Normally Closed  
 2 = COM  
 3 = NO = Normally Open

**CAUTION!**



**Various operating states**

NC (1) and COM (2) are closed in the following states:  
 - upon alarm  
 - upon wire break  
 - upon power failure

Rating of floating alarm contacts:

Min. switching current	10 mA
Max. switching voltage	250V AC / 30V DC
Max. switching current	(according to VDE) 3 A
Contact material	AgNi (silver nickel)

### 9.6. Connection of BEKO sensors

The connection diagram shows the options for the connection of the BEKO sensors.

Sensor	RS485	SDI	Pulse	0 - 10 V			4 - 20 mA		
				2-wire	3-wire	4-wire	2-wire	3-wire	4-wire
SD11 / SD21							X		
SD23	X					X			X
SP11 / SP21 / SP61							X		
SP22 / SP62					X	X			
SF13 / SF53	X		X					X	
FS109 / FS211		X							
OCV compact	X						X		
PC 400	X								
PT 1000						X			

#### 9.6.1. Connection of METPOINT® SD11 / SD21

Pin assignment of plug-type connector, M12 x 1, 4-pin, A-coded		
Pin assignment of connector Transmitter side	Pin assignment of connector Bush side view	Pin assignment of connector Screw side

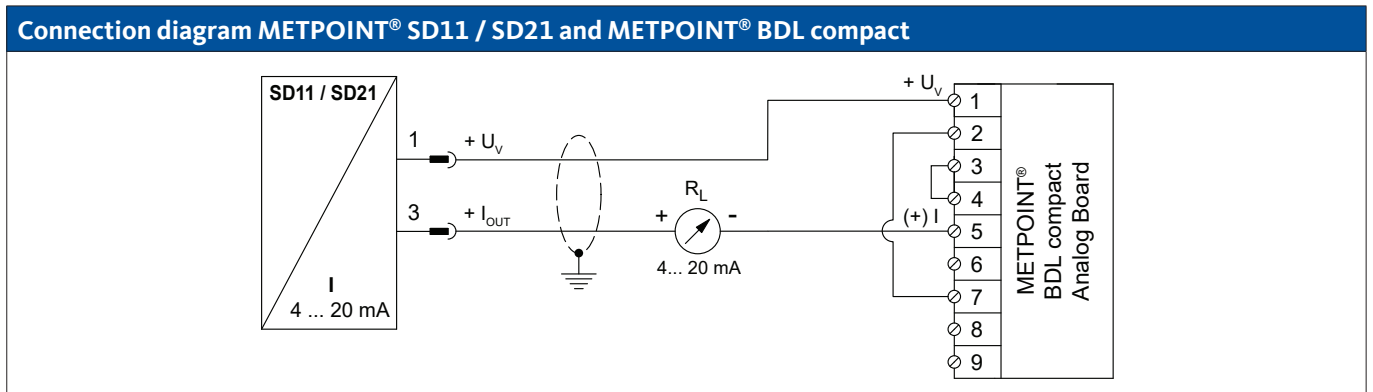

##### 9.6.1.1. Analogue - 2-wire, 4 ... 20 mA



Pin assignment - sensor		Function	Wire colour	Pin assignment BDL compact	
PIN-1	+ U <sub>v</sub>	Plus (+) output, voltage supply	brown	PIN-1	+ U <sub>v</sub>
PIN-3	+ I <sub>OUT</sub>	Current output	white	PIN-5	(+) I
PIN-4		not assigned			
PIN-2		not assigned			

9.6.2. Connection of METPOINT® SD23

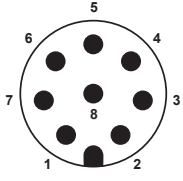
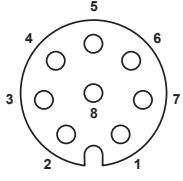
Pin assignment of plug-type connector, M12 x 1, 8-pin, A-coded

Pin assignment of connector Transmitter side	Pin assignment of connector Bush side view	Pin assignment of connector Screw side
		

9.6.2.1. Analogue - 4-wire, 4 ... 20 mA

Connection diagram METPOINT® SD23 and METPOINT® BDL compact

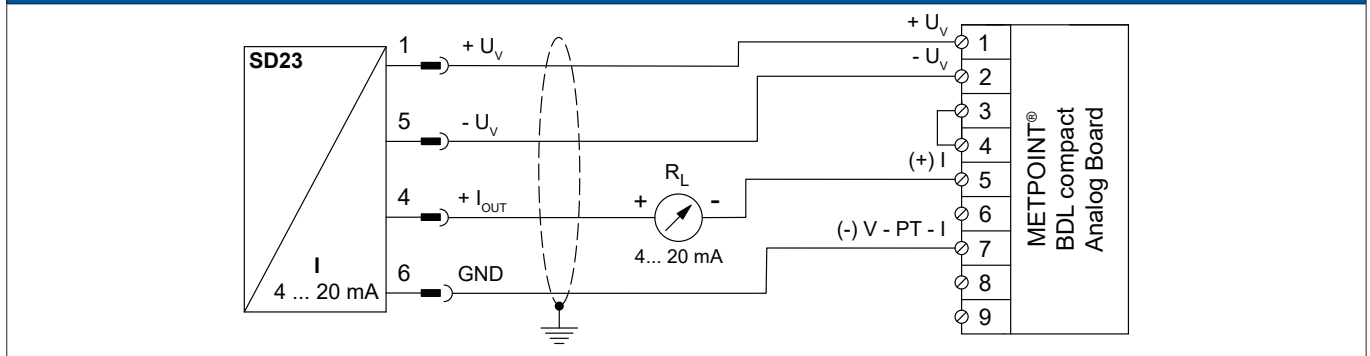

Pin assignment - sensor		Function	Wire colour	Pin assignment BDL compact	
PIN-1	+ U <sub>v</sub>	Plus (+) connection, voltage supply	brown	PIN-1	+ U <sub>v</sub>
PIN-4	+ I <sub>OUT</sub>	Current output	white	PIN-5	(+) I
PIN-6	GND	Analogue reference potential	black	PIN-7	(-) V - PT - I
PIN-5	- U <sub>v</sub>	Minus (-) connection, voltage supply	blue	PIN-2	- U <sub>v</sub>
PIN-2		not assigned			
PIN-3		not assigned			
PIN-7		not assigned			
PIN-8		not assigned			

### 9.6.2.2. Analogue - 4-wire, 0 ... 10 V

Connection diagram METPOINT® SD23 and METPOINT® BDL compact

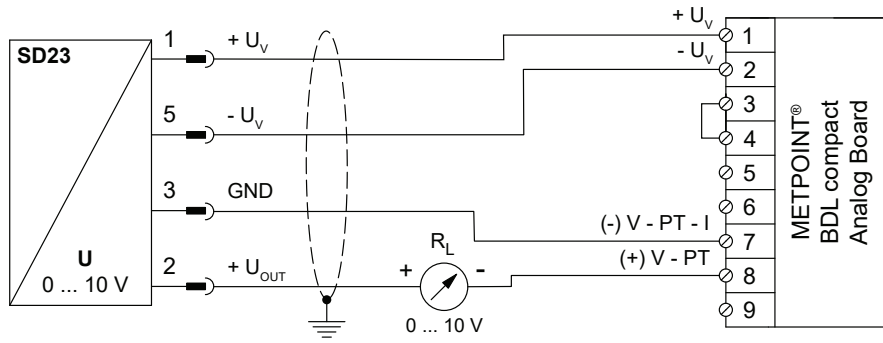

Pin assignment - sensor		Function	Wire colour	Pin assignment BDL compact	
PIN-1	+ U <sub>v</sub>	Plus (+) connection, voltage supply	brown	PIN-1	+ U <sub>v</sub>
PIN-5	- U <sub>v</sub>	Minus (-) connection, voltage supply	blue	PIN-2	- U <sub>v</sub>
PIN-3	GND	Analogue reference potential	black	PIN-7	(-) V - PT - I
PIN-2	+ U <sub>OUT</sub>	Voltage output	white	PIN-8	(+) V - PT
PIN-4		not assigned			
PIN-6		not assigned			
PIN-7		not assigned			
PIN-8		not assigned			

### 9.6.2.3. Digital - bidirectional RS485 bus system

Connection diagram METPOINT® SD23 and METPOINT® BDL compact

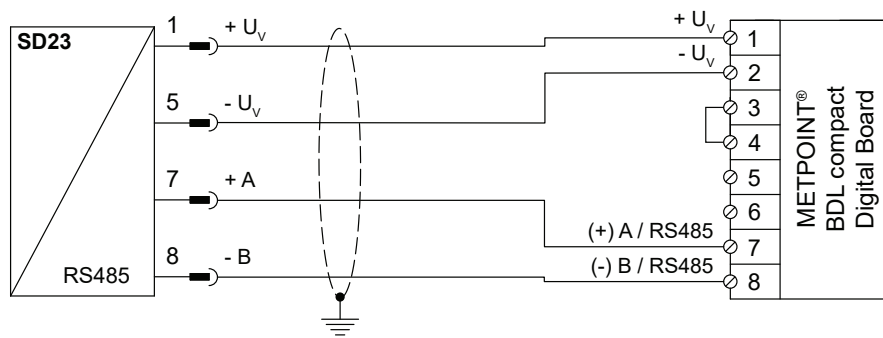

Pin assignment - sensor		Function	Wire colour	Pin assignment BDL compact	
PIN-1	+ U <sub>v</sub>	Plus (+) connection, voltage supply	brown	PIN-1	+ U <sub>v</sub>
PIN-5	- U <sub>v</sub>	Minus (-) connection, voltage supply	blue	PIN-2	- U <sub>v</sub>
PIN-7	Bus A (+)	Non-inverted signal (+) from RS485 interface	white	PIN-7	(+) A / RS485
PIN-8	Bus B (-)	Inverted signal (-) from RS485 interface	black	PIN-8	(-) B / RS485
PIN-2		not assigned			
PIN-3		not assigned			
PIN-4		not assigned			
PIN-6		not assigned			

### 9.6.3. Connection of METPOINT® SP11 / SP21 / SP61

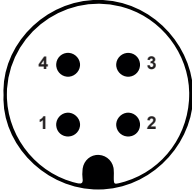
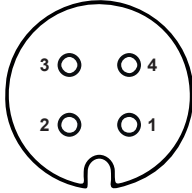
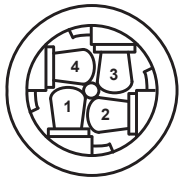
Pin assignment of plug-type connector, M12 x 1, 4-pin, A-coded		
Pin assignment of connector Transmitter side	Pin assignment of connector Bush side view	Pin assignment of connector Screw side
		

#### 9.6.3.1. Analogue - 2-wire, 4 ... 20 mA

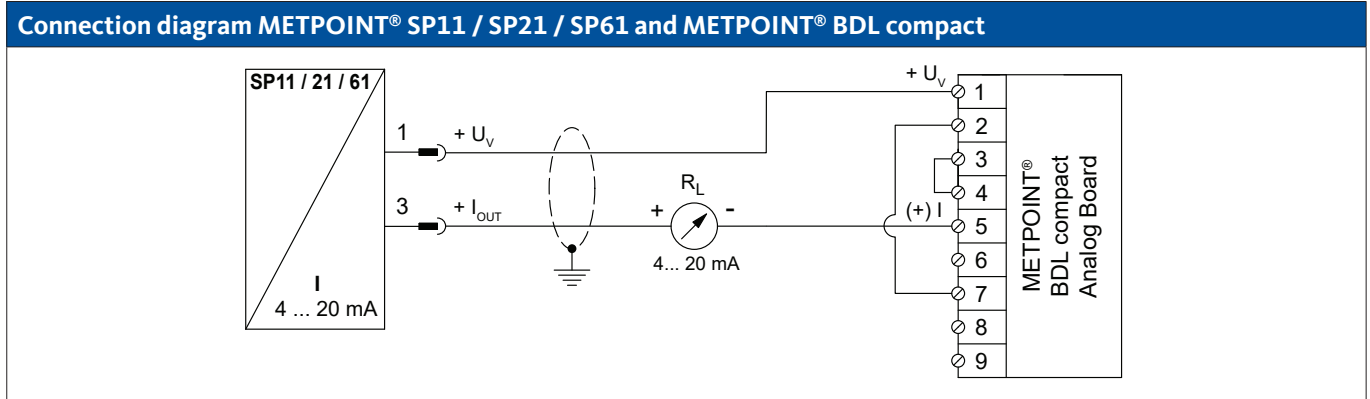

Pin assignment - sensor		Function	Wire colour	Pin assignment BDL compact	
PIN-1	+ U <sub>v</sub>	Plus (+) connection, supply voltage	brown	PIN-1	+ U <sub>v</sub>
PIN-3	+ I <sub>OUT</sub>	Current output	blue	PIN-5	(+) I
PIN-4		not assigned			
PIN-2		not assigned			

### 9.6.4. Connection of METPOINT® SP22 / SP62

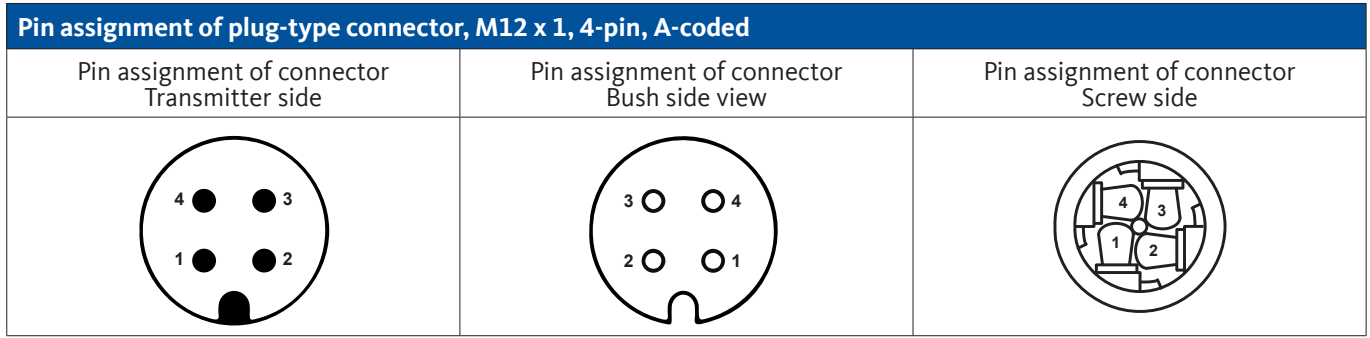

#### 9.6.4.1. Analogue - 4-wire, 0 ... 10 V

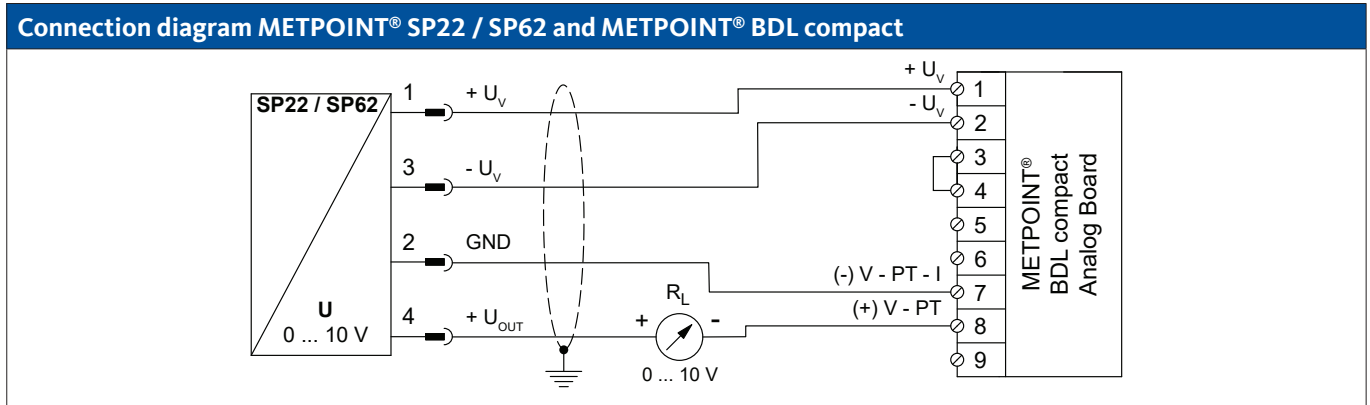

Pin assignment - sensor		Function	Wire colour	Pin assignment BDL compact	
PIN-1	+ U <sub>v</sub>	Plus (+) connection, voltage supply	brown	PIN-1	+ U <sub>v</sub>
PIN-5	- U <sub>v</sub>	Minus (-) connection, voltage supply	blue	PIN-2	- U <sub>v</sub>
PIN-3	GND	Analogue reference potential	black	PIN-7	(-) V - PT - I
PIN-2	+ U <sub>OUT</sub>	Voltage output	white	PIN-8	(+) V - PT

#### 9.6.4.2. Analogue - 3-wire, 0 ... 10 V

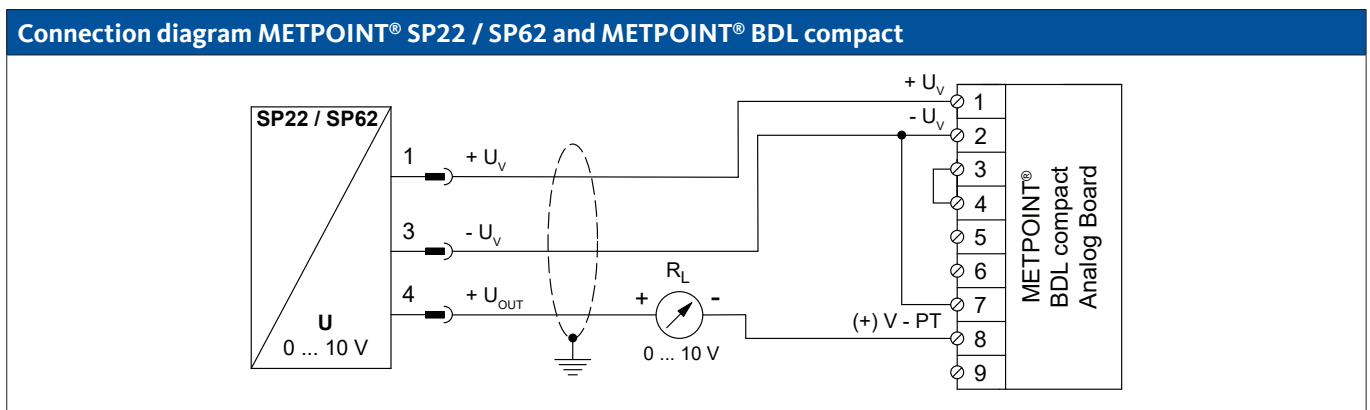

Pin assignment - sensor		Function	Wire colour	Pin assignment BDL compact	
PIN-1	+ U <sub>v</sub>	Plus (+) connection, voltage supply	brown	PIN-1	+ U <sub>v</sub>
PIN-3	- U <sub>v</sub>	Minus (-) connection, voltage supply	blue	PIN-2	- U <sub>v</sub>
PIN-4	+ U <sub>OUT</sub>	Voltage output	white	PIN-8	(+) V - PT
PIN-2		not assigned			

### 9.6.5. Connection of METPOINT® SF13 / SF53

#### Pin assignment of plug-type connector A, M12 x 1, 5-pin, A-coded (according to EN 61076-2-101)

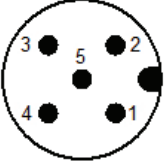
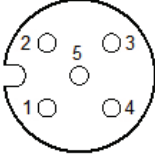
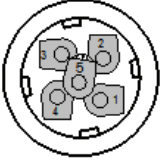
Pin assignment of connector Transmitter side	Pin assignment of connector Bush side view	Pin assignment of connector Screw side
		

#### Pin assignment of plug-type connector B, M12 x 1, 5-pin, A-coded (according to EN 61076-2-101)

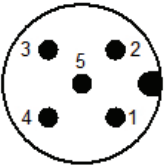
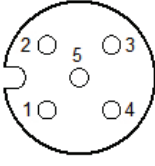
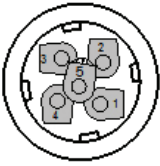
Pin assignment of connector Transmitter side	Pin assignment of connector Bush side view	Pin assignment of connector Screw side
		

#### 9.6.5.1. Digital - bidirectional RS485 bus system

Connection by means of plug-type connector A.

#### Connection diagram METPOINT® SF13 / SF53 and METPOINT® BDL compact (digital board)

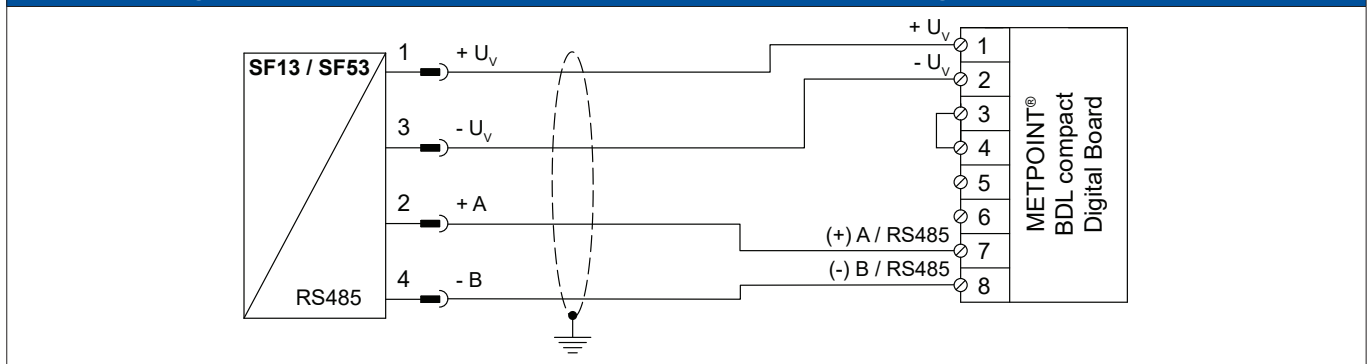

Pin assignment - sensor		Function	Wire colour	Pin assignment BDL compact	
PIN-1	+ U <sub>v</sub>	Plus (+) connection, voltage supply	brown	PIN-1	+ U <sub>v</sub>
PIN-3	- U <sub>v</sub>	Minus (-) connection, voltage supply	blue	PIN-2	- U <sub>v</sub>
PIN-2	+ A	Non-inverted signal (+) from RS485 interface	white	PIN-7	(+) RS485 (A)
PIN-4	- B	Inverted signal (-) from RS485 interface	black	PIN-8	(-) RS485 (B)
PIN-5		not assigned	grey		

### 9.6.5.2. Analogue - 3-wire, 4 ... 20 mA

Connection by means of plug-type connector A.

Connection diagram METPOINT® SF13 / SF53 and METPOINT® BDL compact (analogue board)

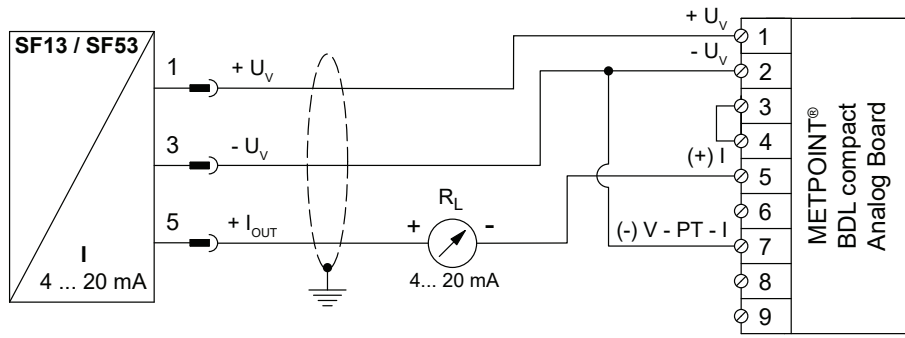

Pin assignment - sensor		Function	Wire colour	Pin assignment BDL compact	
PIN-1	+ U <sub>v</sub>	Plus (+) connection, voltage supply	brown	PIN-1	+ U <sub>v</sub>
PIN-3	- U <sub>v</sub>	Minus (-) connection, voltage supply	blue	PIN-2	- U <sub>v</sub>
PIN-5	+ I <sub>OUT</sub>	Current output	grey	PIN-5	(+) I
PIN-2		not assigned	white		
PIN-4		not assigned	black		

### 9.6.5.3. Analogue - galvanically isolated pulse output

Connection by means of plug-type connector B.

Connection diagram METPOINT® SF13 / SF53 and METPOINT® BDL compact (analogue)

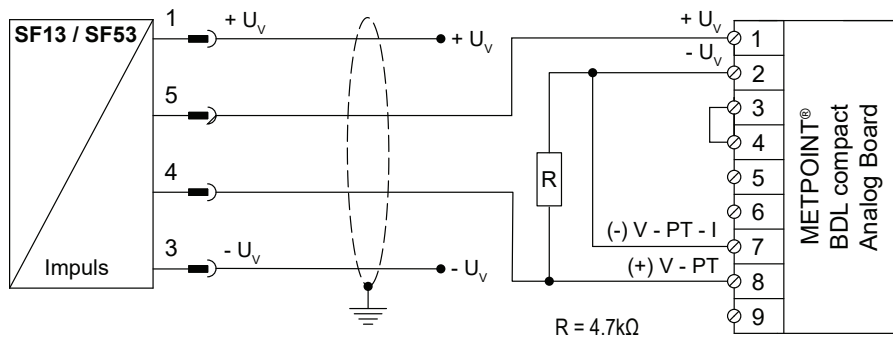

Pin assignment - sensor		Function	Wire colour	Pin assignment BDL compact	
PIN-1	+ U <sub>v</sub>	Plus (+) connection, voltage supply	brown		
PIN-4	Pulse	Pulse	black	PIN-1	+ U <sub>v</sub>
PIN-5	Pulse	Pulse	grey	PIN-8	(+) V - PT
PIN-3	- U <sub>v</sub>	Minus (-) connection, voltage supply	blue		
PIN-2		not assigned	white		



9.6.6. Connection of METPOINT® FS109 / FS211

Pin assignment of plug-type connector, M12 x 1, 5-pin, A-coded

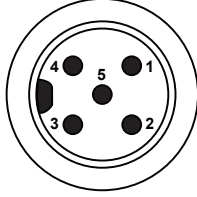
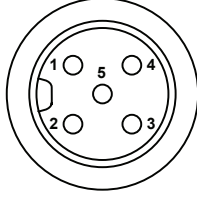
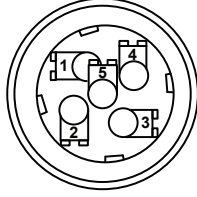
Pin assignment of connector Transmitter side	Pin assignment of connector Bush side view	Pin assignment of connector Screw side
		

9.6.6.1. Digital - SDI interface

Connection diagram METPOINT® FS109 / FS211 and METPOINT® BDL compact

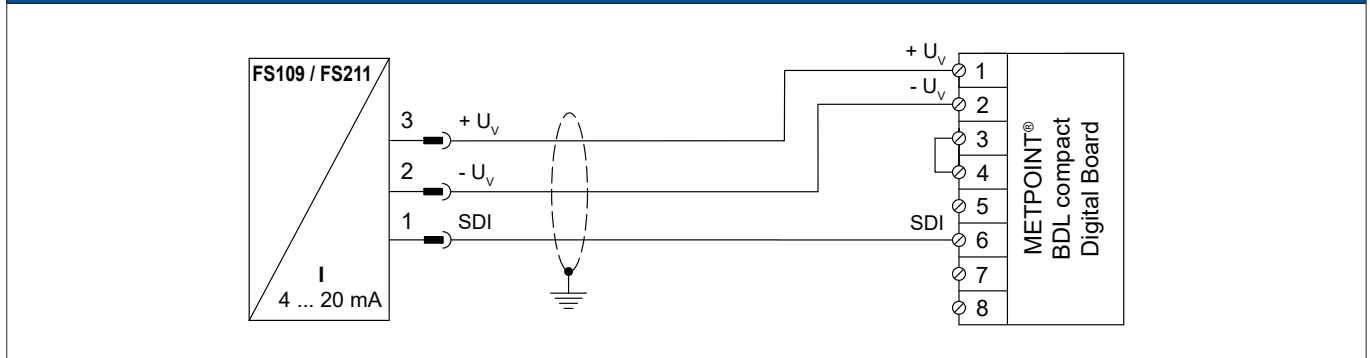

Pin assignment - sensor		Function	Wire colour	Pin assignment BDL compact	
PIN-3	+ U <sub>v</sub>	Plus (+) connection, voltage supply	blue	PIN-1	+ U <sub>v</sub>
PIN-2	- U <sub>v</sub>	Minus (-) connection, voltage supply	white	PIN-2	- U <sub>v</sub>
PIN-1	SDI	Digital interface	brown	PIN-6	SDI
PIN-4		not assigned			
PIN-5		not assigned			

### 9.6.7. Connection of OCV compact

#### 9.6.7.1. Analogue - 2-wire, 4 ... 20 mA

Connection diagram METPOINT® OCV compact and METPOINT® BDL compact

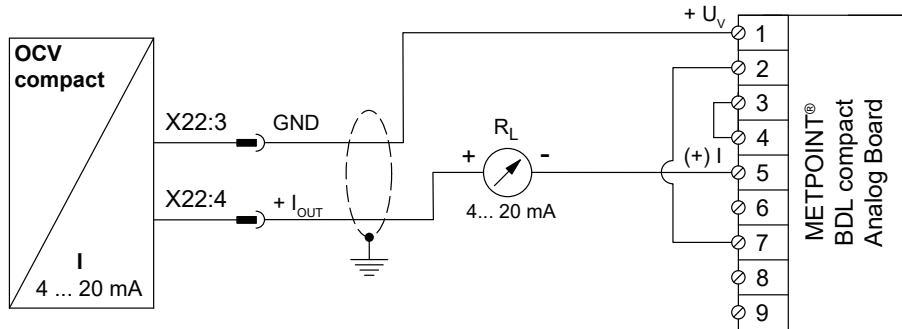

Assignment OCV compact		Function	Wire colour	Pin assignment BDL compact	
X22:8		not assigned			
X22:9		not assigned			
X22:3	GND	Analogue reference potential	blue	PIN-1	(+) I
X22:4	I <sub>out</sub>	Current output	brown	PIN-5	+ U <sub>v</sub>

#### 9.6.7.2. Digital - bidirectional RS485 bus system

Connection diagram METPOINT® OCV compact and METPOINT® BDL compact

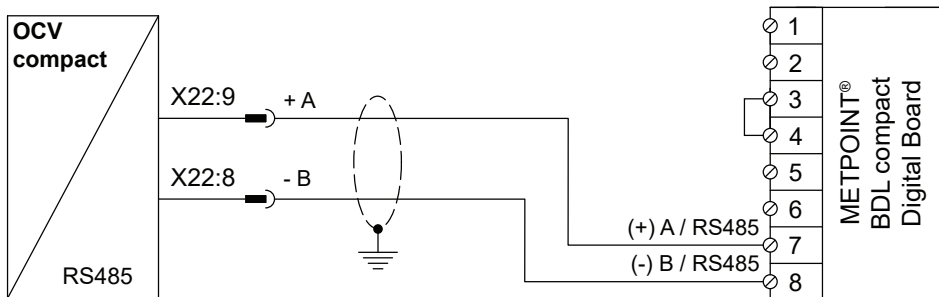

Assignment OCV compact		Function	Wire colour	Pin assignment BDL compact	
X22:9	Bus A (+)	Non-inverted signal (+) from RS485 interface	brown	PIN-7	(+) A / RS485
X22:8	Bus B (-)	Inverted signal (-) from RS485 interface	blue	PIN-8	(-) B / RS485
X22:4		not assigned			
X22:3		not assigned			

### 9.6.8. Connection of PC 400

#### 9.6.8.1. Digital - bidirectional RS485 bus system

Connection diagram PC 400 and METPOINT® BDL compact

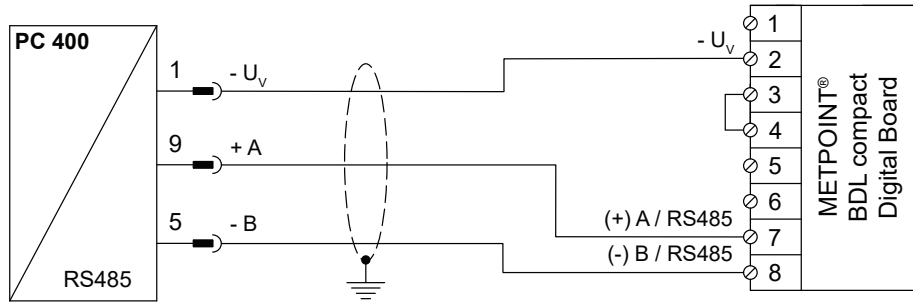

Pin assignment - sensor		Function	Wire colour	Pin assignment BDL compact	
PIN-1	- U <sub>v</sub>	Minus (-) connection, voltage supply	blue	PIN-2	- U <sub>v</sub>
PIN-9	Bus A (+)	Non-inverted signal (+) from RS485 interface	white	PIN-7	(+) A / RS485
PIN-5	Bus B (-)	Inverted signal (-) from RS485 interface	black	PIN-8	(-) B / RS485
PIN-6		not assigned			
PIN-7		not assigned			
PIN-8		not assigned			
PIN-2		not assigned			
PIN-3		not assigned			
PIN-4		not assigned			

### 9.6.9. Connection of PT 1000

#### 9.6.9.1. Analogue - 4-wire, 0 ... 10 V

Connection diagram PT 1000 and METPOINT® BDL compact

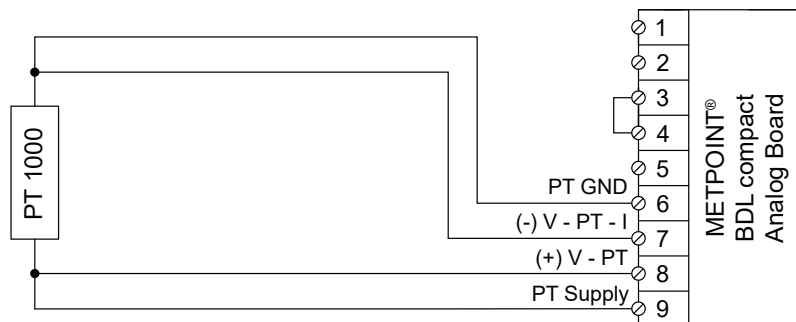

Pin assignment - sensor		Function	Wire colour	Pin assignment BDL compact	
-	-	Minus (-) connection	red	PIN-6	PT GND
-	-	Minus (-) connection	red	PIN-7	(-) V - PT - I
-	-	Plus (+) connection	white	PIN-8	(+) V - PT
-	-	Plus (+) connection	white	PIN-9	PT supply

### 9.7. Connection of further sensors

Further analogue and digital sensors compact can be connected to the METPOINT® BDL compact. The different connection options are shown sorted according how the measuring signals are transmitted.

#### 9.7.1. Analogue, 0/4 ... 20 mA

##### 9.7.1.1. Analogue - 2-wire 0/4 ... 20 mA

Connection diagram analogue 2-wire, 0/4... 20 mA

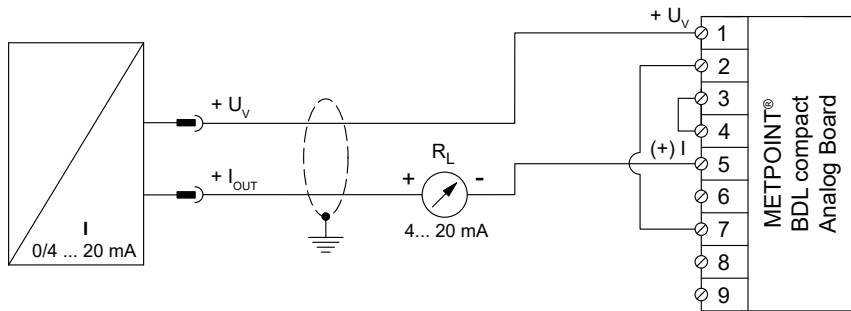

Pin assignment - sensor	Function	Pin assignment BDL compact	
+ U <sub>V</sub>	Plus (+) output, voltage supply	PIN-1	+ U <sub>V</sub>
+ I <sub>OUT</sub>	Current output	PIN-5	(+) I

##### 9.7.1.2. Analogue - 3-wire 0/4 ... 20 mA

Connection diagram analogue 3-wire, 0/4... 20 mA

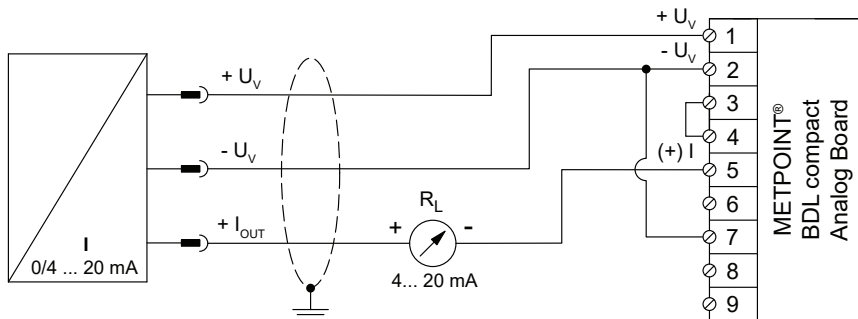

Pin assignment - sensor	Function	Pin assignment BDL compact	
+ U <sub>V</sub>	Plus (+) output, voltage supply	PIN-1	+ U <sub>V</sub>
- U <sub>V</sub>	Minus (-) connection, voltage supply	PIN-2	- U <sub>V</sub>
+ I <sub>OUT</sub>	Current output	PIN-5	(+) I

### 9.7.1.3. Analogue - 4-wire 0/4 ... 20 mA

Connection diagram analogue 4-wire, 0/4... 20 mA

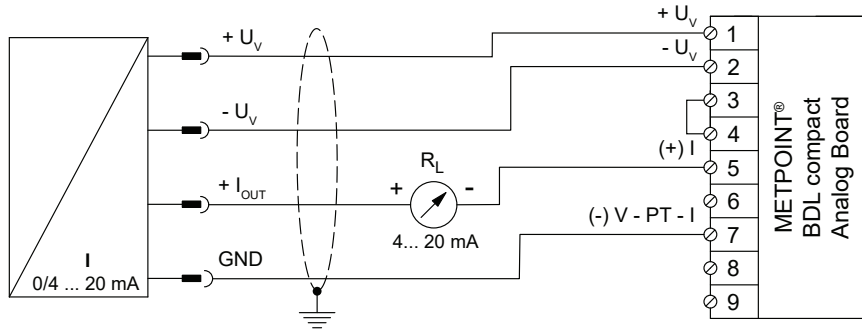

Pin assignment - sensor	Function	Pin assignment BDL compact	
+ U <sub>v</sub>	Plus (+) output, voltage supply	PIN-1	+ U <sub>v</sub>
- U <sub>v</sub>	Minus (-) connection, voltage supply	PIN-2	- U <sub>v</sub>
+ I <sub>OUT</sub>	Current output	PIN-5	(+) I
GND	Analogue reference potential	PIN-7	(-) V - PT - I

### 9.7.2. Analogue, 0 ... 1/10/30 V

#### 9.7.2.1. Analogue - 3-wire, 0 ... 1/10/30 V

Connection diagram analogue 3-wire, 0 ... 1/10/30 V

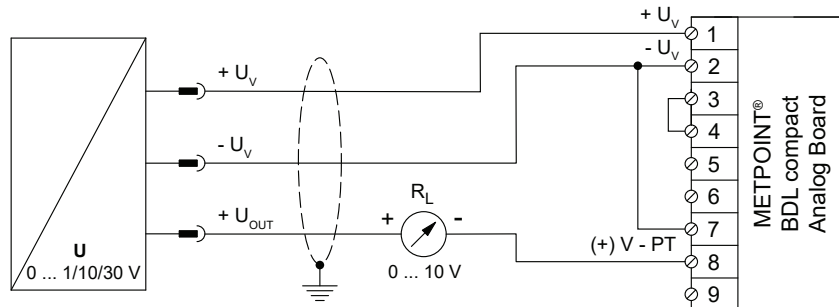

Pin assignment - sensor	Function	Pin assignment BDL compact	
+ U <sub>v</sub>	Plus (+) output, voltage supply	PIN-1	+ U <sub>v</sub>
- U <sub>v</sub>	Minus (-) connection, voltage supply	PIN-2	- U <sub>v</sub>
+ U <sub>out</sub>	Voltage output	PIN-8	(+) V - PT

### 9.7.2.2. Analogue - 4-wire, 0 ... 1/10/30 V

Connection diagram analogue 4-wire, 0 ... 1/10/30 V

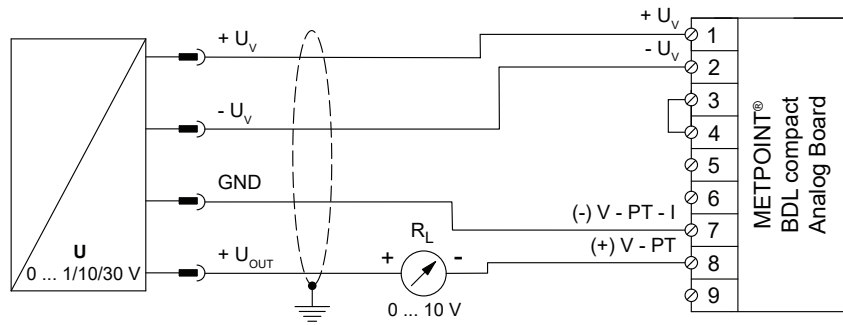

Pin assignment - sensor	Function	Pin assignment BDL compact	
+ U <sub>v</sub>	Plus (+) output, voltage supply	PIN-1	+ U <sub>v</sub>
- U <sub>v</sub>	Minus (-) connection, voltage supply	PIN-2	- U <sub>v</sub>
GND	Analogue reference potential	PIN-7	(-) V - PT - I
+ U <sub>out</sub>	Voltage output	PIN-8	(+) V - PT

### 9.7.3. Digital - SDI interface

#### 9.7.3.1. Digital - 3-wire SDI-interface

Connection diagram 3-wire SDI-interface

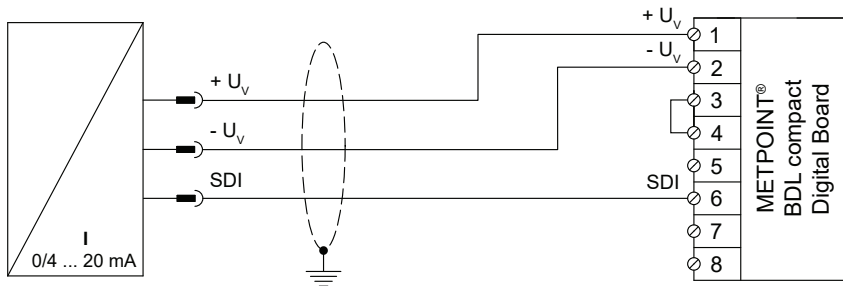

Pin assignment - sensor	Function	Pin assignment BDL compact	
+ U <sub>v</sub>	Plus (+) connection, voltage supply	PIN-1	+ U <sub>v</sub>
- U <sub>v</sub>	Minus (-) connection, voltage supply	PIN-2	- U <sub>v</sub>
SDI	Digital interface	PIN-6	SDI

### 9.7.3.2. Digital - 4-wire SDI-interface

Connection diagram 4-wire SDI-interface

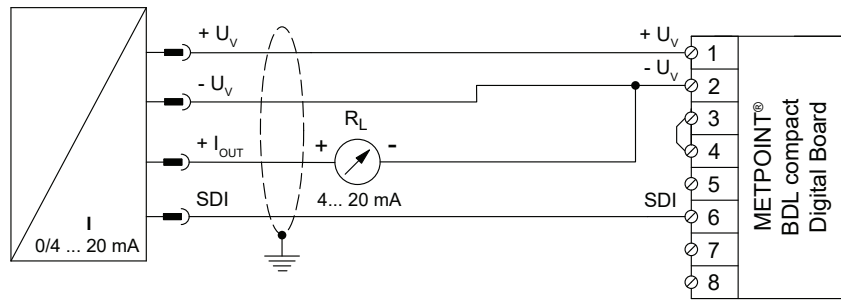

Pin assignment - sensor	Function	Pin assignment BDL compact	
+ U <sub>v</sub>	Plus (+) connection, voltage supply	PIN-1	+ U <sub>v</sub>
- U <sub>v</sub>	Minus (-) connection, voltage supply	PIN-2	- U <sub>v</sub>
+ I <sub>OUT</sub>	Current output	PIN-2	- U <sub>v</sub>
SDI	Digital interface	PIN-6	SDI

### 9.7.4. Digital - bidirectional RS485 bus system

Connection diagram bidirectional RS485 bus system

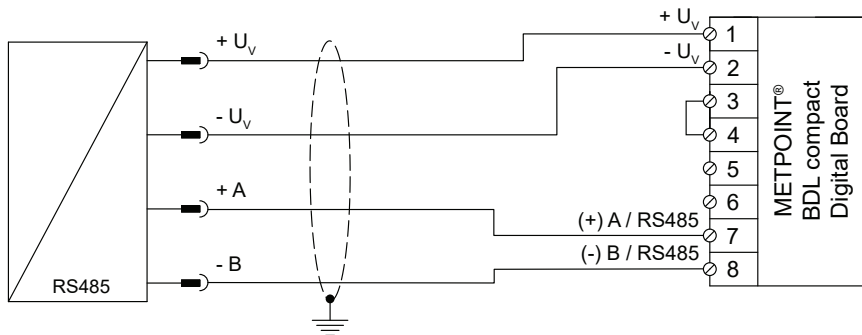

Pin assignment - sensor	Function	Pin assignment BDL compact	
+ U <sub>v</sub>	Plus (+) connection, voltage supply	PIN-1	+ U <sub>v</sub>
- U <sub>v</sub>	Minus (-) connection, voltage supply	PIN-2	- U <sub>v</sub>
Bus A (+)	Non-inverted signal (+) from RS485 interface	PIN-7	(+) A / RS485
Bus B (-)	Inverted signal (-) from RS485 interface	PIN-8	(-) B / RS485

### 9.7.5. Analogue - galvanically isolated pulse sensors

#### Connection diagram pulse sensor

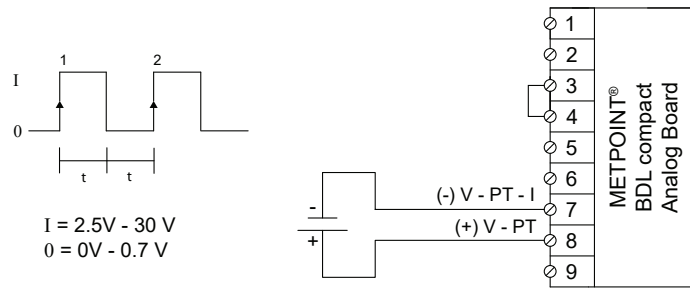

Pin assignment - sensor	Function	Pin assignment BDL compact	
Pulse	Pulse	PIN-7	(-) V - PT - I
Pulse	Pulse	PIN-8	(+) V - PT

#### Connection diagram pulse sensor

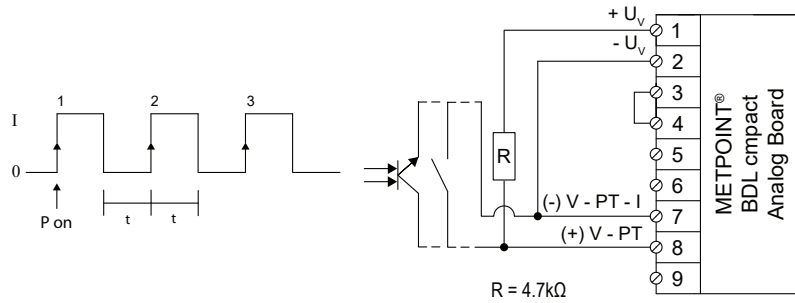

Pin assignment - sensor	Function	Pin assignment BDL compact	
Pulse	Pulse	PIN-7	(-) V - PT - I
Pulse	Pulse	PIN-8	(+) V - PT

#### Connection diagram pulse sensor

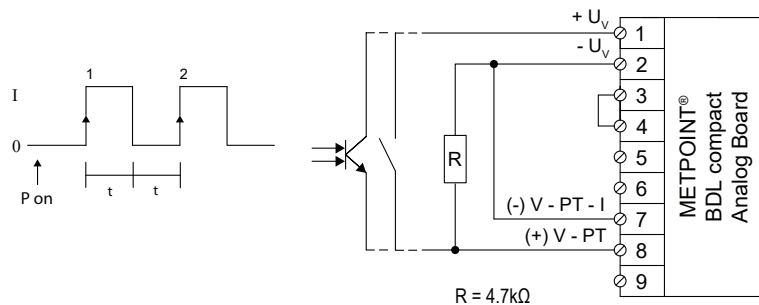

Pin assignment - sensor	Function	Pin assignment BDL compact	
Pulse	Pulse	PIN-7	(-) V - PT - I
Pulse	Pulse	PIN-8	(+) V - PT



### 9.7.6. Resistance sensors

#### 9.7.6.1. 2-wire resistance sensors

Connection diagram 2-wire resistance sensors

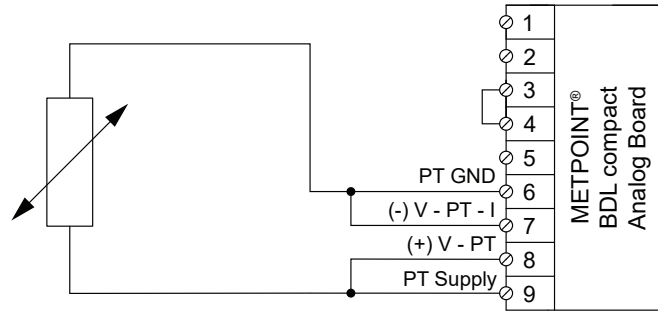

Pin assignment - sensor	Function	Pin assignment BDL compact	
-	Minus (-) connection	PIN-6	PT GND
-	Minus (-) connection	PIN-7	(-) V - PT - I
-	Plus (+) connection	PIN-8	(+) V - PT
-	Plus (+) connection	PIN-9	PT supply

#### 9.7.6.2. 3-wire resistance sensors

Connection diagram 3-wire resistance sensors

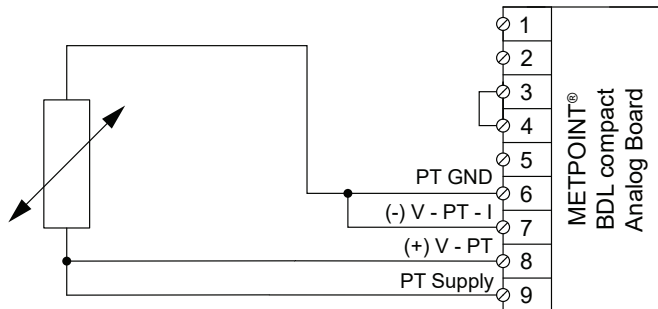

Pin assignment - sensor	Function	Pin assignment BDL compact	
-	Minus (-) connection	PIN-6	PT GND
-	Minus (-) connection	PIN-7	(-) V - PT - I
-	Plus (+) connection	PIN-8	(+) V - PT
-	Plus (+) connection	PIN-9	PT supply

### 9.7.6.3. 4-wire resistance sensors

Connection diagram 4-wire resistance sensors

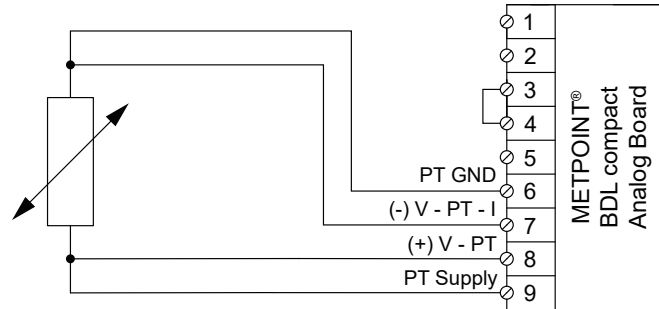

Pin assignment - sensor	Function	Pin assignment BDL compact	
-	Minus (-) connection	PIN-6	PT GND
-	Minus (-) connection	PIN-7	(-) V - PT - I
-	Plus (+) connection	PIN-8	(+) V - PT
-	Plus (+) connection	PIN-9	PT supply

### 9.8. Connection of external displays (PLC / ZTL)

Power signals for an external PLC / ZTL or external display unit can be tapped at the METPOINT® BDL compact. The different connection options are shown sorted according how the measuring signals are transmitted.

#### 9.8.1. Analogue, 0/4 ... 20 mA

##### 9.8.1.1. Analogue - 2-wire 0/4 ... 20 mA

Connection diagram analogue 2-wire, 0/4... 20 mA

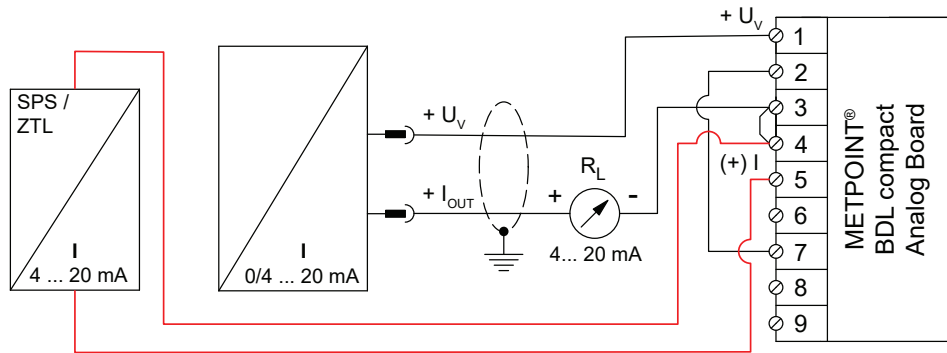

Pin assignment - sensor	Function	Pin assignment BDL compact	
+ U <sub>V</sub>	Plus (+) output, voltage supply	PIN-1	+ U <sub>V</sub>
+ I <sub>OUT</sub>	Current output	PIN-3	Loop
-	Current input PLC / ZTL	PIN-4	Loop
-	Current output PLC / ZTL	PIN-5	(+) I

##### 9.8.1.2. Analogue - 3-wire 0/4 ... 20 mA

Connection diagram analogue 3-wire, 0/4... 20 mA

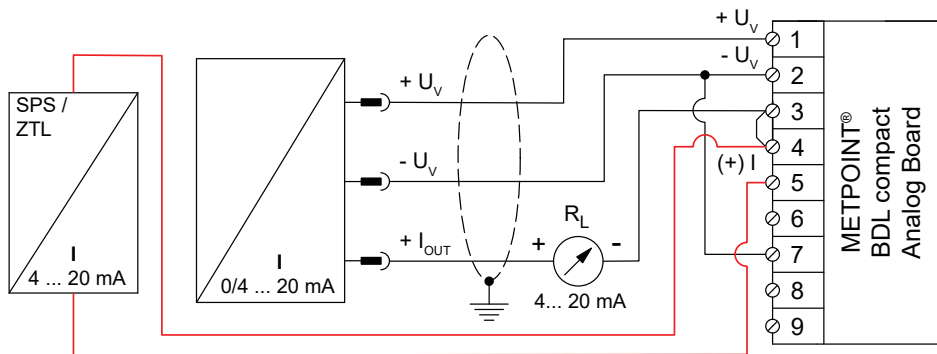

Pin assignment - sensor	Function	Pin assignment BDL compact	
+ U <sub>V</sub>	Plus (+) output, voltage supply	PIN-1	+ U <sub>V</sub>
- U <sub>V</sub>	Minus (-) connection, voltage supply	PIN-2	- U <sub>V</sub>
+ I <sub>OUT</sub>	Current output	PIN-3	Loop
-	Current input PLC / ZTL	PIN-4	Loop
-	Current output PLC / ZTL	PIN-5	(+) I

### 9.8.1.3. Analogue - 4-wire 0/4 ... 20 mA

Connection diagram analogue 4-wire, 0/4... 20 mA

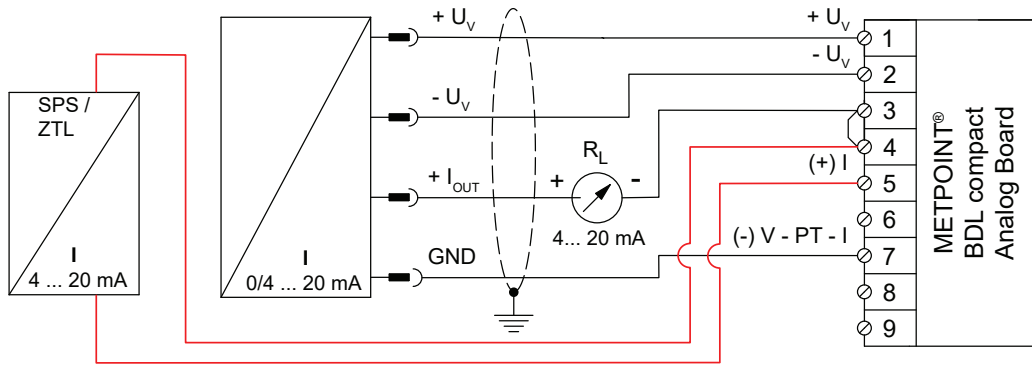

Pin assignment - sensor	Function	Pin assignment BDL compact	
+ U <sub>v</sub>	Plus (+) output, voltage supply	PIN-1	+ U <sub>v</sub>
- U <sub>v</sub>	Minus (-) connection, voltage supply	PIN-2	- U <sub>v</sub>
GND	Analogue reference potential	PIN-7	(-) V - PT - I
+ I <sub>OUT</sub>	Current output	PIN-3	Loop
-	Current input PLC / ZTL	PIN-4	Loop
-	Current output PLC / ZTL	PIN-5	(+) I

### 9.8.2. Digital - SDI interface

#### 9.8.2.1. Digital - 3-wire SDI-interface

Connection diagram analogue 3-wire SDI-interface

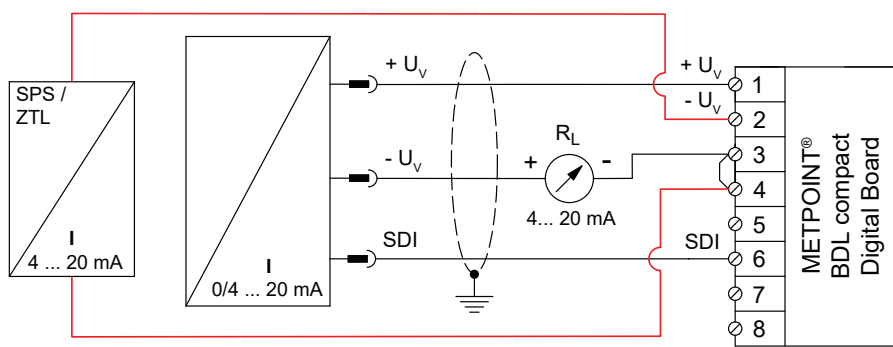

Pin assignment - sensor	Function	Pin assignment BDL compact	
SDI	Digital interface	PIN-6	SDI
+ U <sub>v</sub>	Plus (+) connection, voltage supply	PIN-1	+ U <sub>v</sub>
- U <sub>v</sub>	Minus (-) connection, voltage supply	PIN-3	Loop
-	Current input PLC / ZTL	PIN-4	Loop
-	Current output PLC / ZTL	PIN-2	- U <sub>v</sub>

### 9.8.2.2. Digital - 4-wire SDI-interface

Connection diagram analogue 4-wire SDI-interface

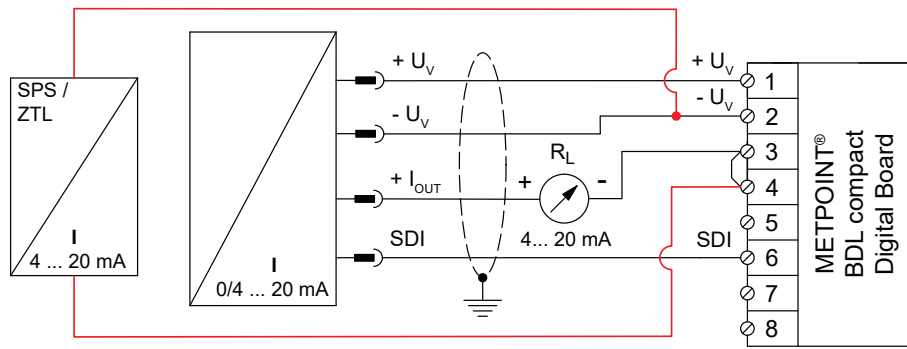

Pin assignment - sensor	Function	Pin assignment BDL compact	
+ U <sub>v</sub>	Plus (+) connection, voltage supply	PIN-1	+ U <sub>v</sub>
- U <sub>v</sub>	Minus (-) connection, voltage supply	PIN-2	- U <sub>v</sub>
SDI	Digital interface	PIN-6	SDI
+ I <sub>OUT</sub>	Current output	PIN-3	Loop
-	Current input PLC / ZTL	PIN-4	Loop
-	Current output PLC / ZTL	PIN-2	- U <sub>v</sub>

### 9.8.3. Digital - bidirectional RS485 bus system

Connection diagram bidirectional RS485 bus system

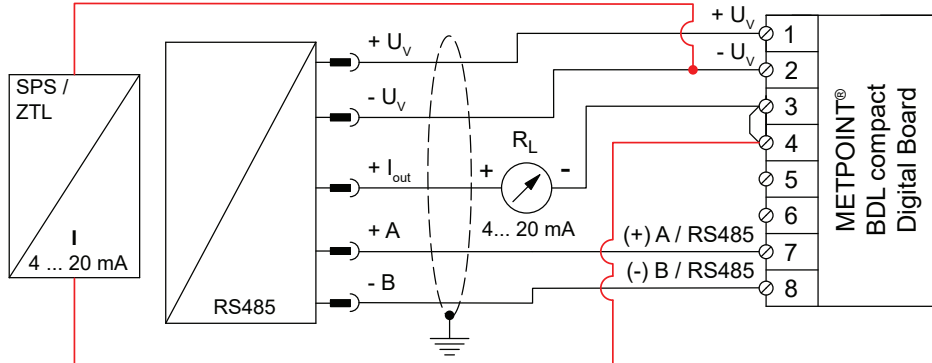

Pin assignment - sensor	Function	Pin assignment BDL compact	
+ U <sub>v</sub>	Plus (+) connection, voltage supply	PIN-1	+ U <sub>v</sub>
- U <sub>v</sub>	Minus (-) connection, voltage supply	PIN-2	- U <sub>v</sub>
Bus A (+)	Non-inverted signal (+) from RS485 interface	PIN-7	(+) A / RS485
Bus B (-)	Inverted signal (-) from RS485 interface	PIN-8	(-) B / RS485
+ I <sub>OUT</sub>	Current output	PIN-3	Loop
-	Current input PLC / ZTL	PIN-4	Loop
-	Current output PLC / ZTL	PIN-2	- U <sub>v</sub>

## 10. Connecting the METPOINT® BDL compact with a PC

NOTICE	Static IP address
	<p>The IP addresses of the PC and the METPOINT® BDL compact must be static (DHCP off) and part of the same network.                      If the IP address of the METPOINT® BDL compact has been changed, you must restart the device!                      IP address of BDL compact: see chapter 11.2.3.3                      Restarting BDL compact: see chapter „11.2.3.7.5. Restoring factory settings“ page 74</p>

To connect the METPOINT® BDL compact to a PC, use an 8-wire crossover cable with RJ45 plug-type connectors at both ends. Alternatively use an Ethernet cable with a crossover adapter.



Crossover cable with RJ45 plug-type connectors

Crossover adapter

After the METPOINT® BDL compact has been connected to the PC, you can use the METPOINT® READER SW201 software for the evaluation of data in the form of charts and tables.

### Network settings for Windows PC:

#### Windows 7:

Start → Control Panel → Network and Sharing Center → Change adapter settings → LAN Connection → Properties → Internet Protocol Version 4 (TCP/IPv4) → Use the following IP address → Enter the IP address and subnet mask  
 Then: OK → OK → Close

#### Windows Vista:

Start → Control Panel → Network and Sharing Center → Manage network connections → LAN Connection → Properties → Internet Protocol Version 4 (TCP/IPv4) → Use the following IP address → Enter the IP address and subnet mask  
 Then: OK → OK → Close

#### Windows XP:

Start → Settings → Control Panel → Network Connection → LAN Connection → Properties → Internet Protocol (TCP/IP) → Use the following IP address → Enter the IP address and subnet mask.  
 Then: OK → OK → Close

## 11. Operation of METPOINT® BDL compact

The BDL is operated through a menu-driven, intuitive touch screen. To select a menu option, touch it lightly with your finger or a soft-pointed pen.

### **Caution:**

Do not use normal pens or pointed implements as these could damage the foil!

After the sensors have been connected, they must be configured.

Entries or changes can be made in the white fields. The measured values are displayed as values or in the form of curves.

Text in **green letters** refers mainly to figures in the respective chapter. Important menus and menu options are also shown with **green letters**.

The menu navigation is generally shown in **green letters**!

### 11.1. Home (Main Menu)

From the Home, you can access all available submenus.

#### 11.1.1. Initialisation



After the BDL compact has been switched on, all channels are initialised and the Home is displayed.

### **Caution:**

At the first start-up, there might be no preset channels.

Configure the individual sensors. The relevant information is compiled in chapter „11.2.2. Sensor settings“ page 45.

### 11.1.2. Home after switching-on

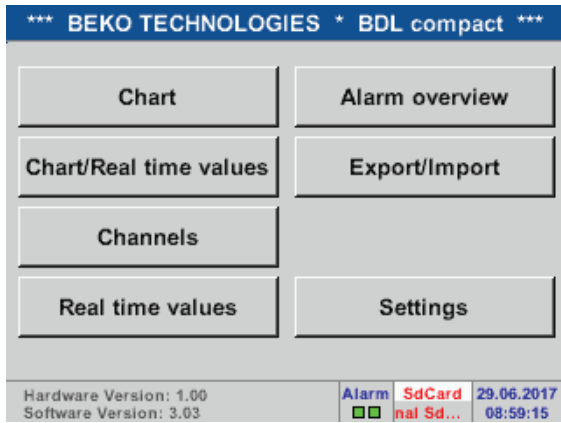

**Important:**

Before entering the sensor settings, select the language and set the time.

**Notice:**

Chapter 11.2.3.1 Language

(English menu navigation: Home → Settings → Device Settings → Set Language)

Chapter 11.2.3.2 Date and time

(English menu navigation: Home → Settings → Device Settings → Date & Time)

### 11.2. Settings

All settings are password-protected!

Settings or changes must always be confirmed with OK!

**Notice:**

When returning to the Home and then calling up the settings menu again, you must once more enter the password!

Home → Settings

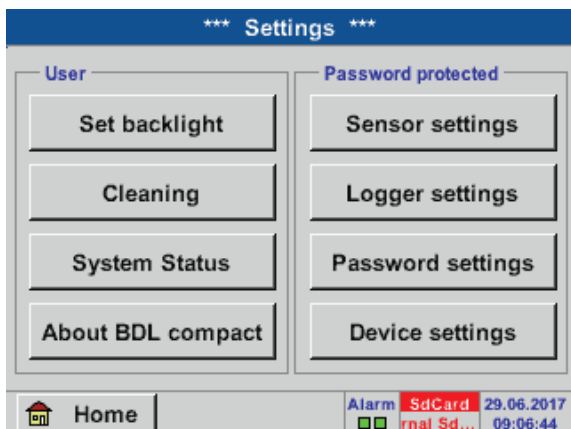

Overview of Settings



### 11.2.1. Password

Home → Settings → Password-setting

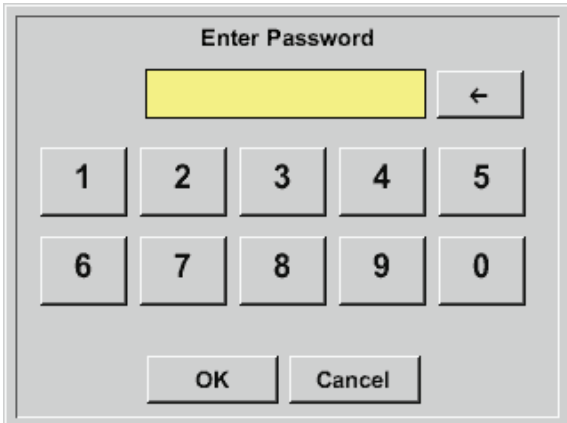

#### Default password (factory settings): 4321

If required, change the password under [Password-setting](#)

Enter the new password twice and confirm with **OK**.

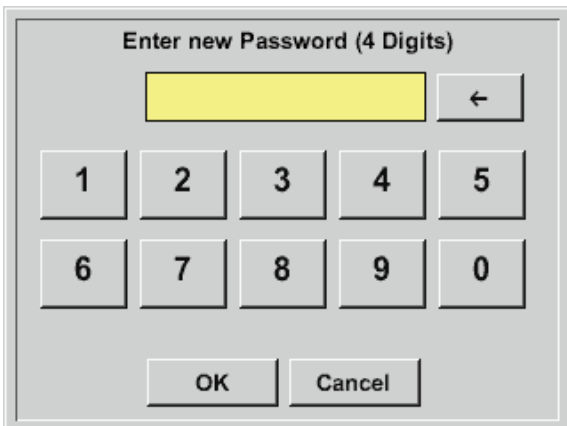

If the two password entries do not match, message [Enter password](#) or [Confirm new password](#) is displayed in red.

If you have forgotten your password, enter the master password and then a new password.

The master password can be requested from BEKO TECHNOLOGIES GmbH, with the serial number of the METPOINT® BDL compact specified in the request.

### 11.2.2. Sensor settings

#### **Important:**

Sensors from BEKO TECHNOLOGIES with SDI signal such as DP109 and FS109/211 are generally pre-configured and can be connected without further adjustments to a free sensor channel!

For instructions regarding the configuration of RS485/Modbus sensors (SD23, etc.) see „11.2.2.10. Type “Modbus”“ page 61.

Home → Settings → Sensor-settings

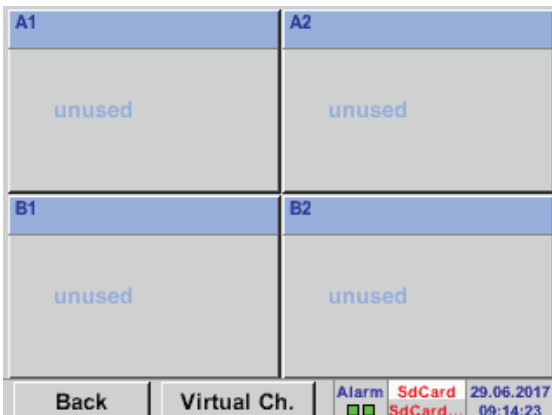

Enter the password. An overview of the available channels is displayed.

Depending on your device mode, there are 2 or 4 channels.

#### **Note:**

Normally, no channels are preset!

**Note:**

The following combinations are supported, depending on the METPOINT® BDL compact model:

Combination \ Channel	1	2	3	4	5	6
A1	D	D	D	A	A	A
A2	D	D	D	A	A	A
B1		D	A		A	D
B2		D	A		A	D

D = digital channel A = analog channel

**11.2.2.1. Selecting sensor type (example: BEKO Digital sensor)**

Home → Settings → Sensor-settings → A1



If no sensor has been configured yet, **No sensor** is displayed in the type field.

Touch the **No sensor** text field to call up a list of sensor types (see next step).

Home → Settings → Sensor-settings → A1 → Type → BEKO-Digital

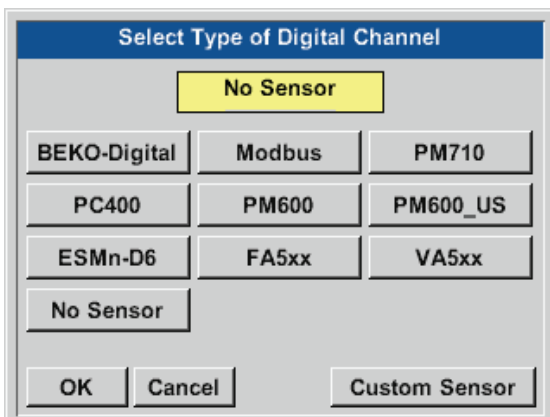

For FS/DP series sensors (e.g. DP109/FS109/FS211), select type **BEKO-Digital** and confirm with **OK**.

Home → Settings → Sensor-settings → A1 → right arrow (2. page) → Diameter

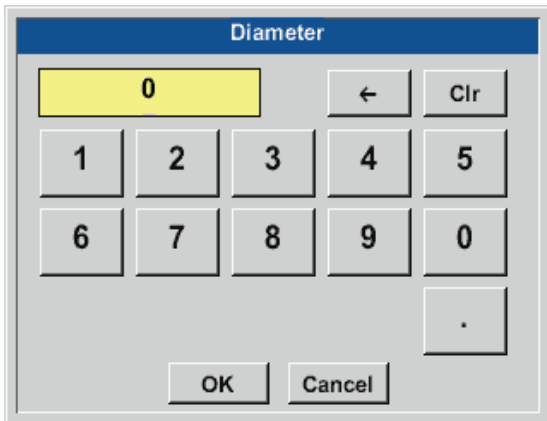
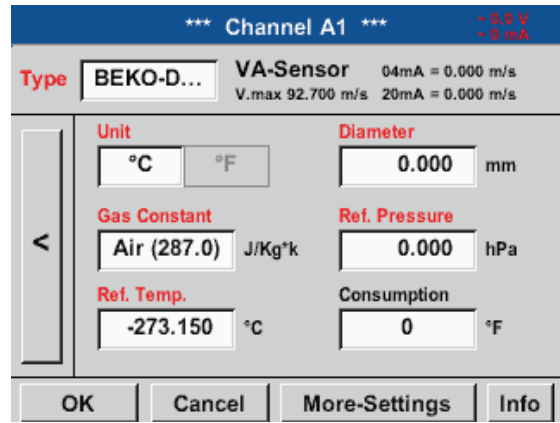
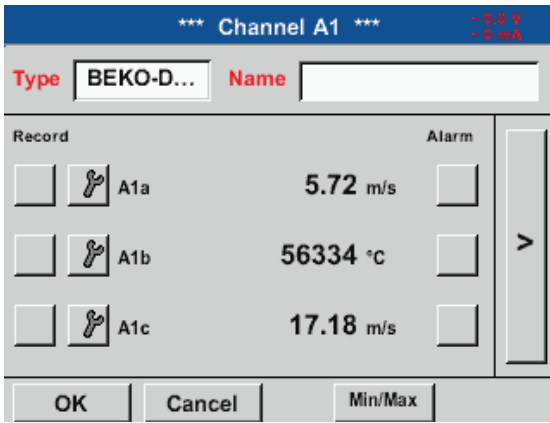

**Important:**

Unless it has been automatically set, enter the **Inside diameter** of the flow pipe.

If the new sensor replaces another one, enter the **Counter** value of the previous sensor (optional).

Confirm with **OK** and go back with **left arrow** (1st page).

**Important:**

The **Inside diameter** should be as exact as possible, as this parameter affects the accuracy of the measuring results!

There is general standard for inside diameter of pipes! (Please ask the manufacturer or measure the pipe yourself!)

Home → Settings → Sensor settings → A1

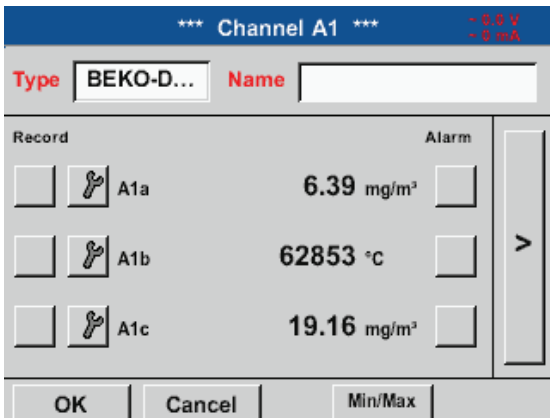

Enter a Name for the virtual channel.

Home → Settings → Sensor settings → A1

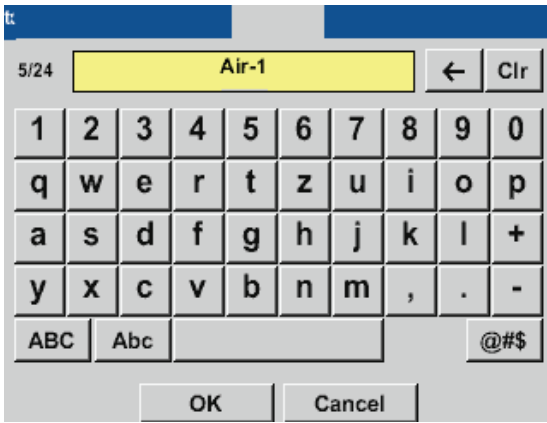

Confirm the changes with **OK**. The sensor configuration is now completed.

For other sensor configuration options, see chapters 11.2.2.5 to 11.2.2.9. See also chapter 11.2.2.7 Labelling and configuring text fields

**Note:**

After confirming with **OK**, the field labels change to black. The values and settings are applied.

**Caution:**

Reference temperature and reference pressure (factory settings 20°C, 1000 hPa): All volume flow (m³/h) and consumption (m³) values shown on the display refer to 20 °C and 1000 hPa (according to ISO 1217). Alternatively, enter 0°C and 1013 hPa (=standard cubic metre according to DIN 1343) as the reference values. Do not enter the operating pressure or the operating temperature as the reference values!

**11.2.2.2. Labelling measurements and defining resolution (decimals)**

**Note:**

To configure the **Resolution** (decimal places), the **Short name** and the **Value name**, click the **Tool** button!

Tool button:



Home → Settings → Sensor-settings → A1 → Tool button

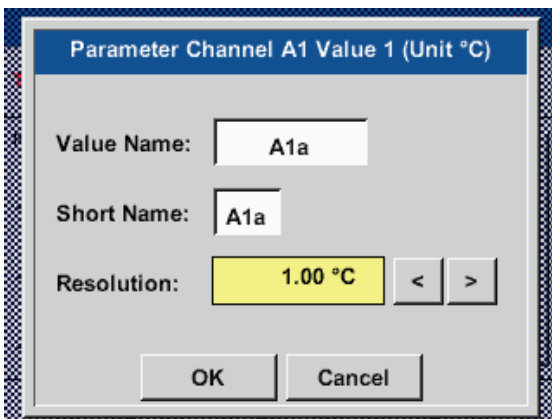

For the **Value** to be recorded, enter a **Name** with max. 10 characters. This name is then used in the **Charts** and **Chart/current values** menus. Otherwise, the default designation (e.g. **A1a**) is displayed. **A1** indicates the channel; **a** is the first value in the channel, **b** would be the second, and **c** the third. To adjust the **Resolution** of the decimal places, touch the arrow buttons (0 to 5 decimal places).

See also chapter 11.2.2.7 Labelling and configuring text fields

### 11.2.2.3. Recording measuring data

Home → Settings → Sensor-settings → A1 → Record button

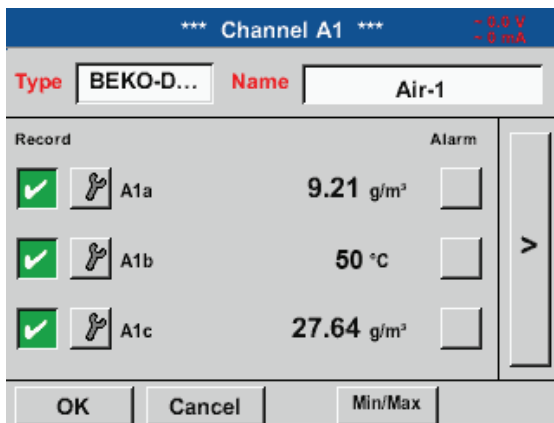

Press the **Record** buttons to select the measurements to be recorded and stored on the **activated data logger**.

#### Caution:

Prior to recording the selected measuring data, configure the data logger and then start it (see chapter 11.2.3 Logger settings (data logger)).

### 11.2.2.4. Alarm settings

Home → Settings → Sensor-settings → A1 → Alarm button

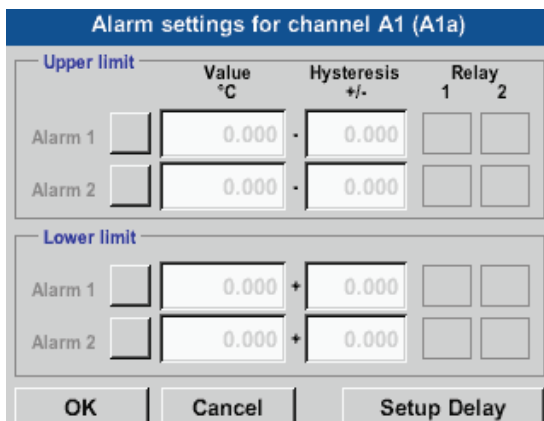

In the alarm settings, you have the option to enter **Alarm 1** and **Alarm 2** including the **Hysteresis** for each channel.

The alarm settings can also be configured in the **Alarm overview** menu (accessible from Home).

Home → Settings → Sensor settings → A1 → Alarm button → Alarm 1 and Alarm 2 buttons + Relay buttons

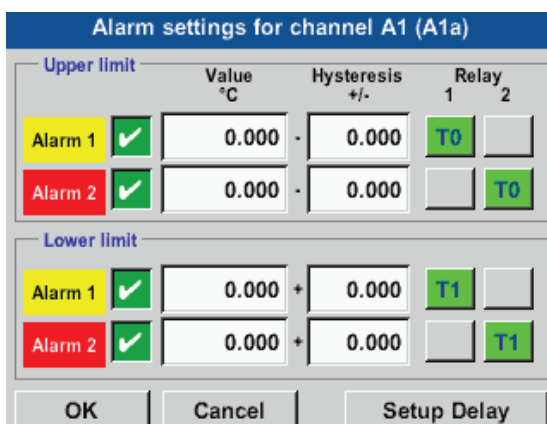

In the example, **Alarm 1** is set to **Relay 1** and **Alarm 2** is set to **Relay 2**.

Home → Settings → Sensor settings → A1 → Alarm button → Relay buttons

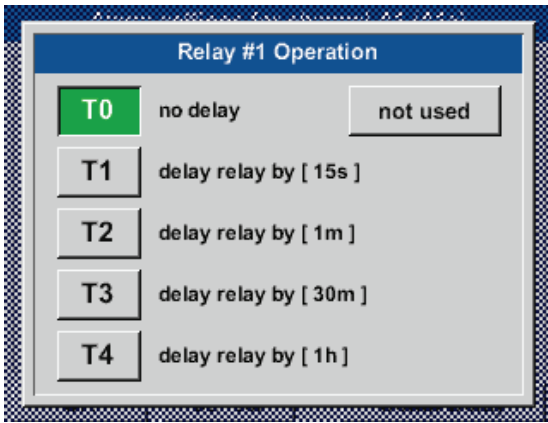

You can choose between 5 different delays.

The set delays (T1 to T4) apply to all the relays.  
s = second  
m = minute  
h = hour

Home → Settings → Sensor-settings → A1 → Alarm button → Delay



The set delays (T1 to T4) apply to all the relays.

Home → Settings → Sensor-settings → A1 → Alarm button → Delay → Delay T1

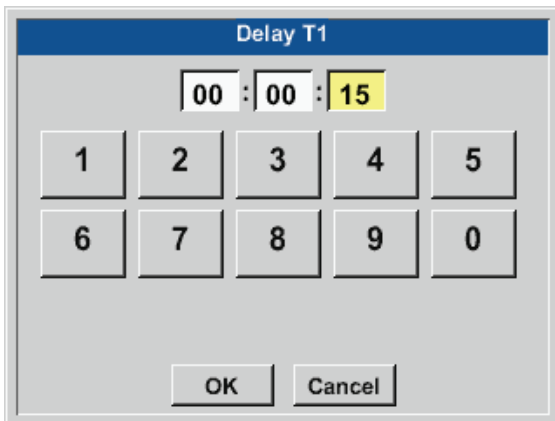

Enter the desired delay for T1.

Delay T0 cannot be modified and is used for instant alarms.

Confirm with **OK**.

Home → Settings → Sensor settings → A1

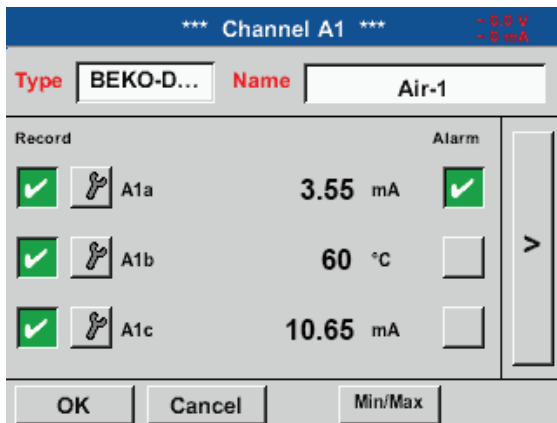

Screen of channel A1 after alarm configuration and activation.

Press **OK** to save and apply the settings.

### 11.2.2.5. Advanced settings (scaling of analog output)

Home → Settings → Sensor-settings → A1 → right arrow (2. page) → Advanced settings

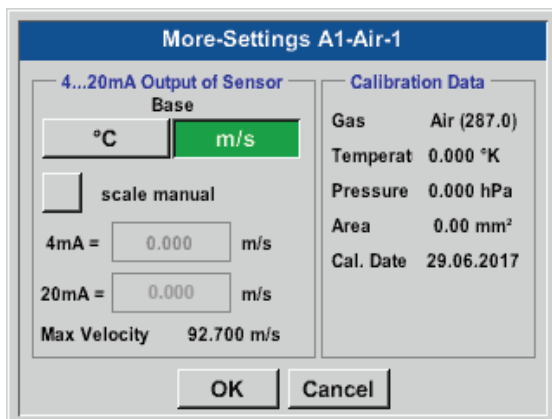

In the **Advanced settings**, you can determine whether the 4-20 mA analog output of the sensor is to be based on flow volume or velocity.

The selected field is displayed in green.

To set the measuring range, touch the **Manual scaling** button.

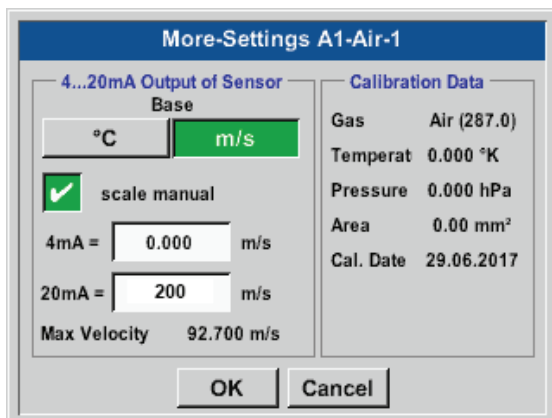

Press **OK** to save and apply the settings.

**Note:** **Advanced settings** are only available for **Digital**.

Press **OK** to save and apply the settings.

**Notice:**

After confirmation with **OK**, the font colour change to black and the values and settings are applied.

### 11.2.2.6. BEKO Digital dew point sensor

Step 1: select a free sensor channel

Home → Settings → Sensor settings → A2

Step 2: select type "BEKO Digital"

Home → Settings → Sensor settings → A2 → Type → BEKO-Digital

Step 3: confirm 2x with OK

Configuration:

- Enter **Name** (see chapter 11.2.2.7 Labelling and configuring text fields)
- Enter alarm settings (see chapter 11.2.2.4 Alarm settings)
- Enter recording settings (see chapter 11.2.2.3 Recording measuring data)
- Enter the **Resolution** (decimal places) (see chapter 11.2.7.5 Defining resolution (decimals))

Home → Settings → Sensor settings → A1

Record		Alarm
<input checked="" type="checkbox"/>	A1a 17.32 µV	<input type="checkbox"/>
<input checked="" type="checkbox"/>	A1b 170478 °C	<input checked="" type="checkbox"/>
<input checked="" type="checkbox"/>	A1c 51.97 µV	<input type="checkbox"/>

The METPOINT® BDL compact recognises whether the connected sensor is a BEKO flow or a dew point sensor, and automatically sets the **Digital** subtype.

<b>NOTICE</b>	<b>SD21/23 and SP21/22 settings</b>
	This instructions do not apply to sensors SD21/23 and SP21/22



### 11.2.2.7. Labelling and configuring text fields

Home → Settings → Sensor settings → A1

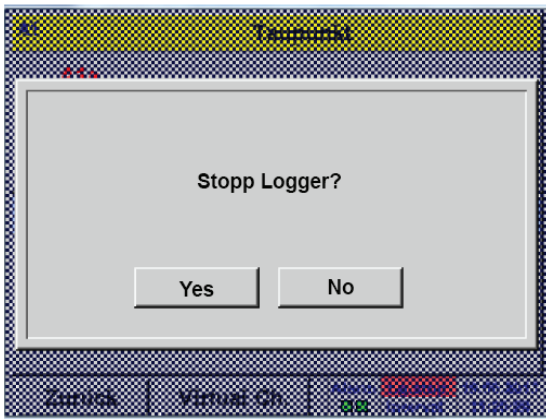

If the data logger is activated, the following window appears. Press **Yes** to activate the data logger. (Data loggers are only activated if the relevant settings and recordings have been configured.)

**Note:**

Before entering or changing sensor settings, set the data logger to **STOP**.

Home → Settings → Sensor settings → A1 → right arrow (2. page)

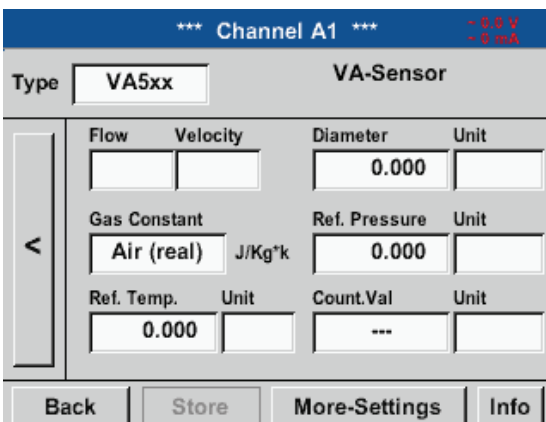

To enter or change a value, touch a white field.

The **Alarm** (see chapter 11.2.2.4 Alarm settings) and **Record** buttons (see chapter 11.2.2.3 Recording measuring data), the **Resolution** for digital places and the **Short name** and the **Value name** (see chapter 11.2.2.2 Labelling measurements and defining resolution), as well as the **Advanced settings** (see chapter 11.2.2.5 Advanced settings) are described in chapter 11.2.2 Sensor settings.

Home → Settings → Sensor-settings → A1 → Name

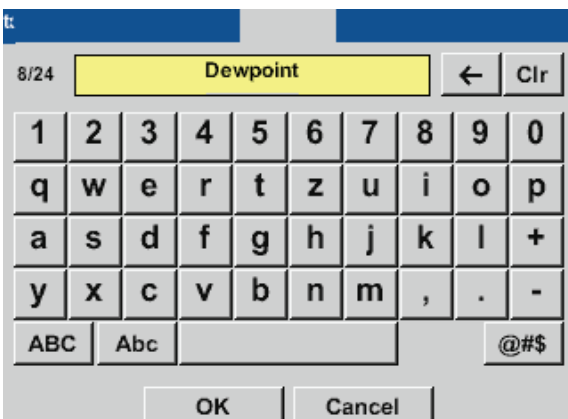

Field names must not be longer than 24 characters.

Home → Settings → Sensor-settings → A1 → Type

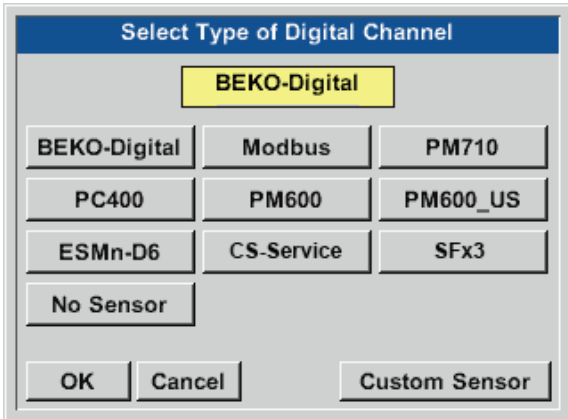

Touch the **Type** text field and select one of the available options

Home → Settings → Sensor-settings → A1 → right arrow (2. page) → Unit

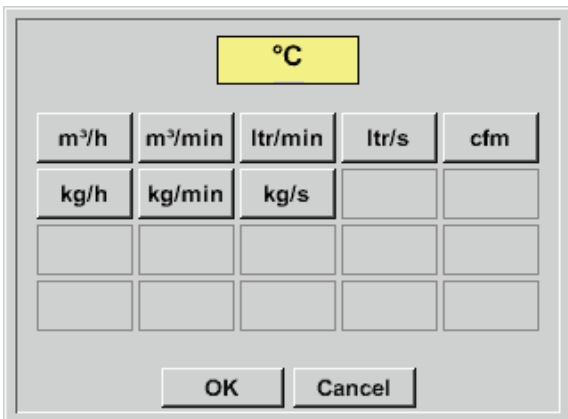

Preselection of matching **Units**.

Home → Settings → Sensor settings → A1 → right arrow (2. page) → Diameter

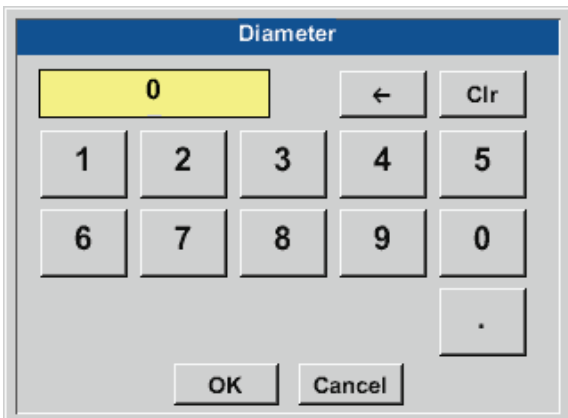

**Important:**  
Unless it has been automatically set, enter the **Inside diameter** of the flow pipe.  
In this example, the **Inside diameter** is 27.5 mm.

**Important:**

The **Inside diameter** should be as exact as possible, as this parameter affects the accuracy of the measuring results!

There is no general standard for inside diameter of pipes!  
(Please ask the manufacturer or, if possible, measure the diameter yourself!)

Home → Settings → Sensor settings → A1 → right arrow (2. page) → Gas constant

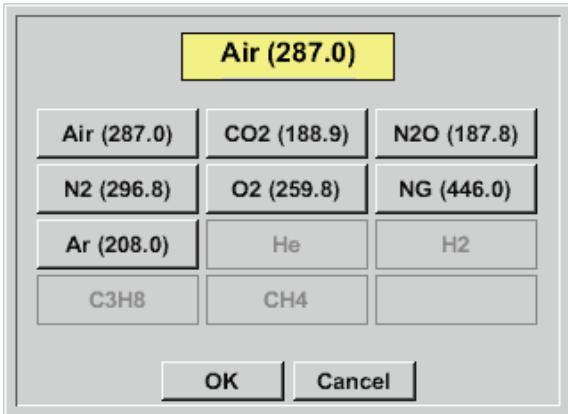

Preselection of matching Units.

The remaining text fields can be labelled and configured in the same manner. For details, see chapter 11.2.2.7 Labelling and configuring text fields!

Home → Settings → Sensor settings → A1 → right arrow (2. page)

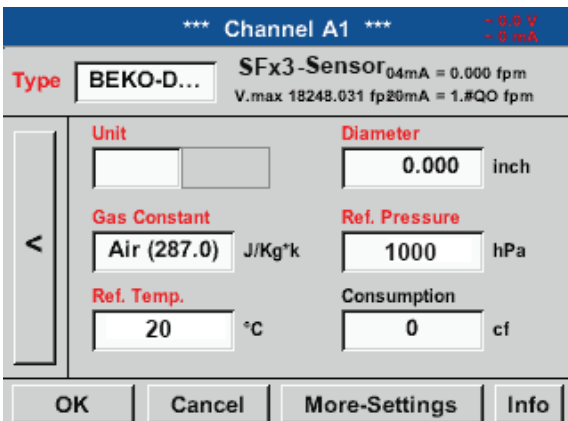

If a text field is displayed with red text, the respective values (e.g. Diameter or Name) have been changed.

**Note:**

After confirming with OK, the field labels change back to black and the settings are applied.

**Caution:**

Reference temperature and reference pressure (factory settings 20°C, 1000 hPa): All volume flow (m³/h) and consumption (m³) values shown on the display refer to 20°C and 1000 hPa (according to ISO 1217). Alternatively, enter 0°C and 1013 hPa (=standard cubic metre according to DIN 1343) as the reference values. Do not enter the operating pressure or the operating temperature as the reference values!

### 11.2.2.8. Configuring analog sensors

Only possible with METPOINT® BDL compact models with fully equipped analog board.

Overview of the possible **Type** settings, including examples.

For **BEKO-Digital** see chapter 11.2.2.8.1 Selecting sensor type (example: BEKO Digital sensor) and chapter 11.2.2.1 BEKO Digital dew point sensor

The **Alarm** and **Record** buttons, the **Resolution** for digital places as well as the **Short name** and the **Value name** are described in chapter 11.2.2 Sensor settings.

For the labelling of the text fields, see chapter 11.2.2.7 Labelling and configuring text fields!

#### 11.2.2.8.1. Type 0/4 – 20 mA / Type 0 – 1/10/30 V

Home → Settings → Sensor-settings → B1 → Type → 4 - 20 mA

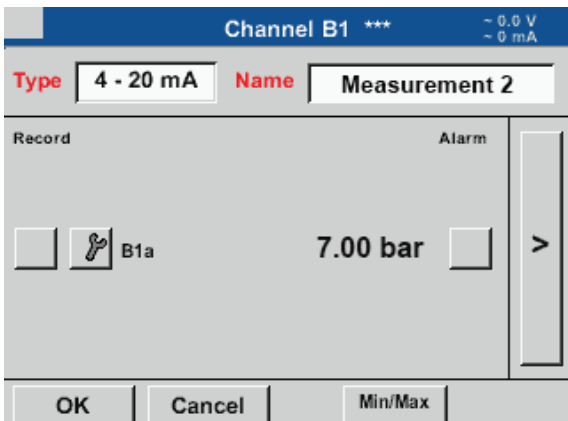

For details regarding the scaling of the sensor (here: **type 4 – 20 mA**, corresponding to 0 – 25 bar), refer to the data sheet of the sensor.

e.g. SP21

Home → Settings → Sensor settings → B1 → right arrow (2. page)

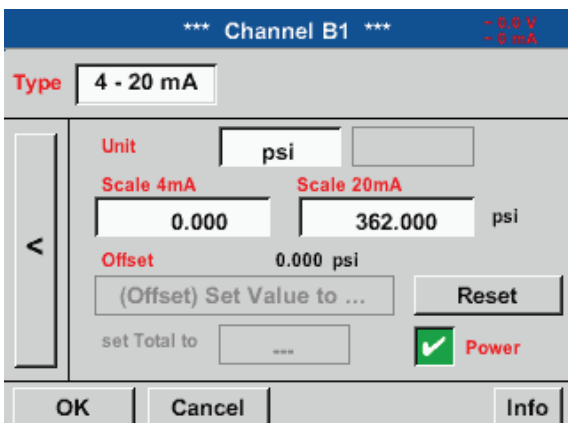

In **Scal. 4 mA**, enter the lower scale limit. In **Scal. 20 mA**, enter the upper scale limit.

The **Ext. sensor supply voltage** is switched on when the sensor requires it.

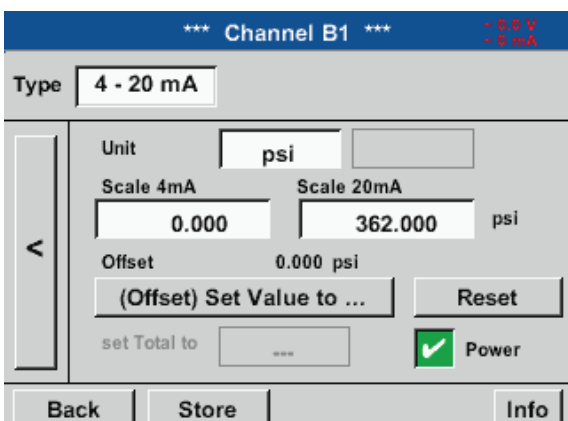

Press the **Set value to (offset)** button to set the measured data from the sensor to a certain value (offset). The positive or negative difference of the **Offset** is displayed.

Press the **Reset** button, to reset the **Offset** to zero.

Home → Settings → Sensor-settings → B1 → Unit

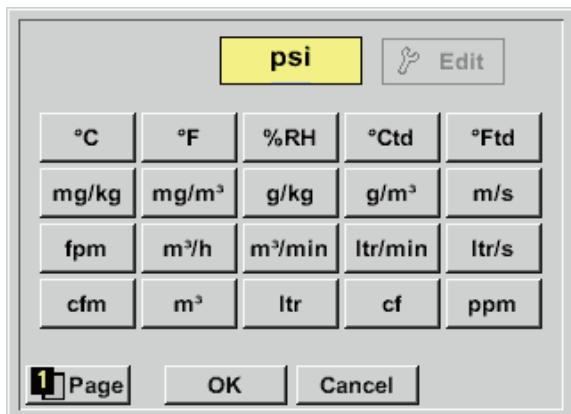

Preselection of suitable units for 0/4 – 20 mA.

Press the Page button to page forward.

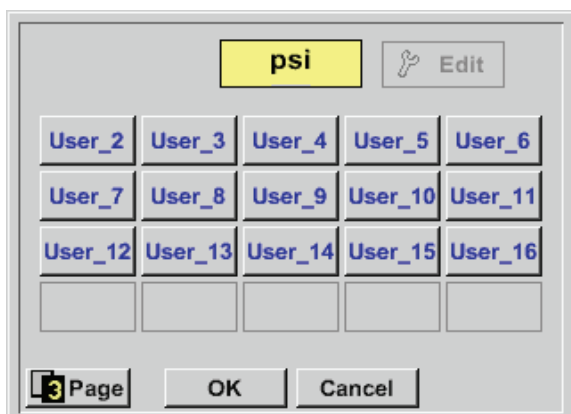

If required, define User units (user-defined units).

Home → Settings → Sensor-settings → B2 → Type → 0/4 – 20 mA

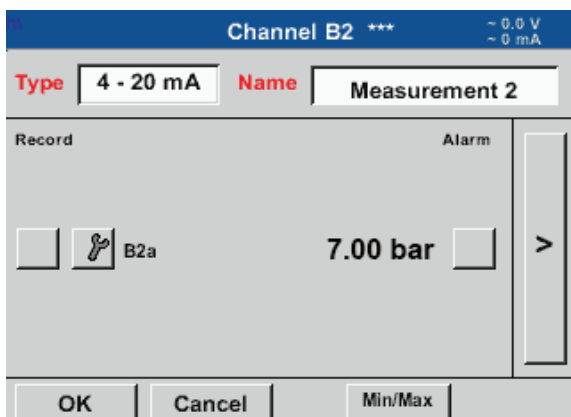

Here: Type 4 – 20 mA.

### 11.2.2.8.2. Type PT100x and KTY81

Home → Settings → Sensor-settings → B2 → right arrow (2. page) → Type

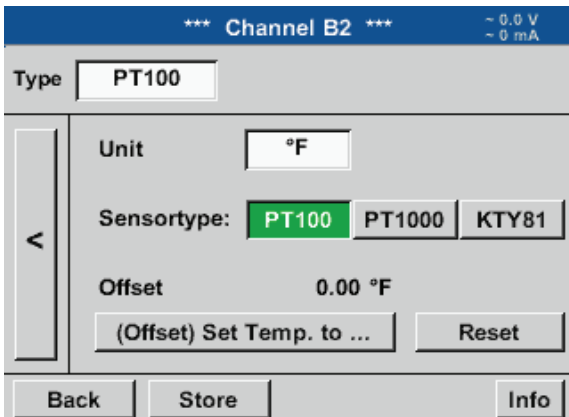

In the example, sensor type **PT100** and **Unit °C** have been chosen. Alternatively, select the sensor types **PT1000** and **KTY81**, and **Unit °F**.

For additional options, refer to chapter 11.2.2.8.1 Type 0 - 1/10/30 V and 0/4 - 20 mA!

### 11.2.2.9. Type "Pulse"

Home → Settings → Sensor-settings → B2 → Type

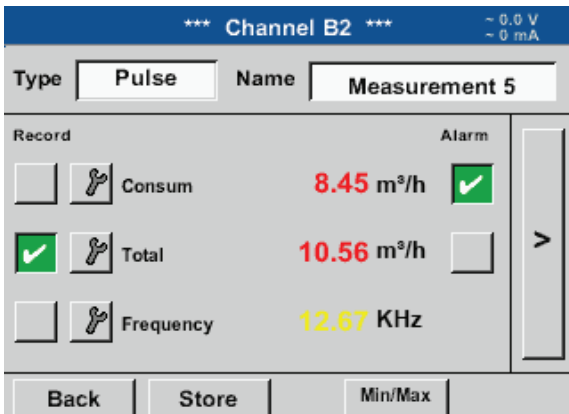

Normally, the numerical value and the unit for **1 pulse** is displayed at the sensor and can be entered in the **1 pulse** field.

**Notice:**

In the example, all text fields are already labelled and/or assigned.

Home → Settings → Sensor settings → B2 → right arrow (2. page) → Pulse unit

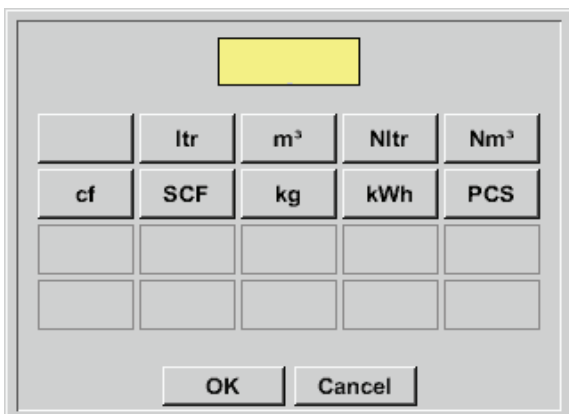

For the **Pulse Unit**, choose a volume flow or energy consumption **Unit**.

Home → Settings → Sensor settings → B2 → right arrow (2. page) → Consumption

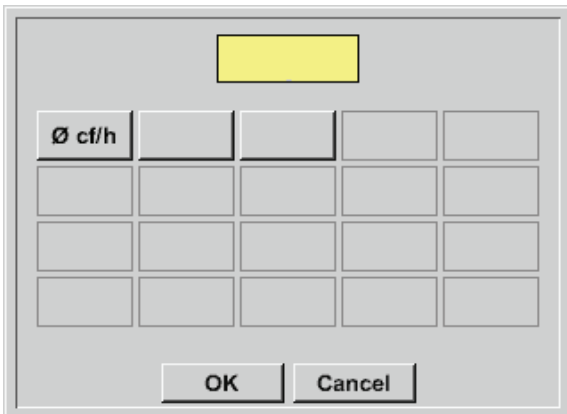

Units for the current Consumption for *Type Pulse*.

**Notice:**

Here: cubic metres!

Home → Settings → Sensor-settings → B2 → right arrow (2. page) → Counter unit

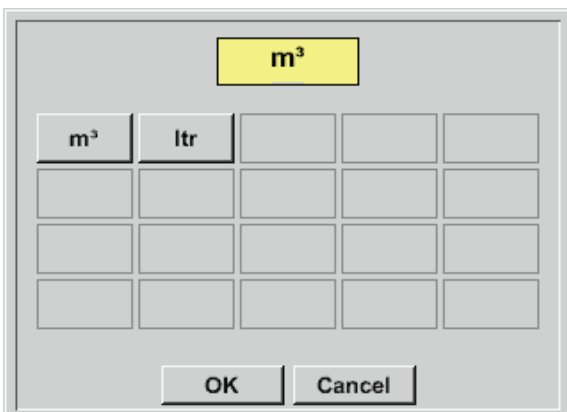

Available units for Counter unit for *Type Pulse*

The Counter can be reset or set to a desired value at any time.

For additional options, see chapter 11.2.2.8.1 Type 0 - 1/10/30 V and 0/4 - 20 mA!

### 11.2.2.9.1. Type "No sensor"

Home → Settings → Sensor-settings → A2 → Type → No sensor

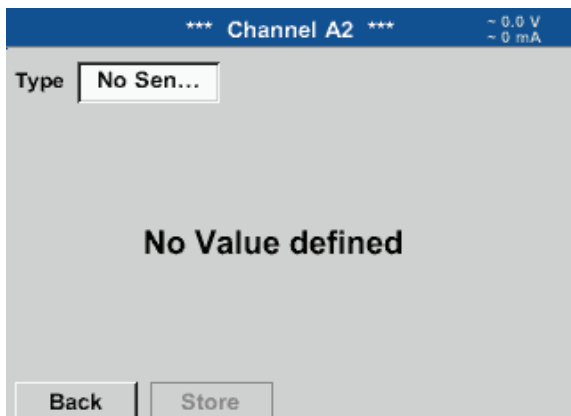

This option is used to declare a channel that is not in use as **not configured**.

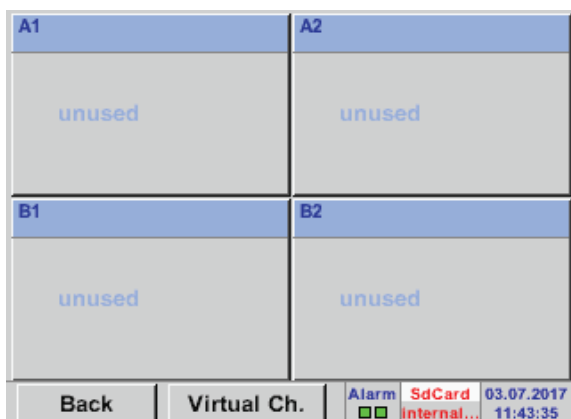

When returning from **No sensor** to the respective sensor settings, the respective channel (here: channel A1) displayed as **free**.



### 11.2.2.10. Type "Modbus"

#### 11.2.2.10.1. Selecting and activating sensor type

Step 1: select a free sensor channel

Home → Settings → Sensor settings → A1

Step 2: select Modbus type

Home → Settings → Sensor-settings → A1 → Type → Modbus

Step 3: confirm with OK

Enter a name (see chapter 11.2.2.7 "Labelling and configuring text fields").

Home → Settings → Sensor-settings → A1 → right arrow (2. page) → VA → use

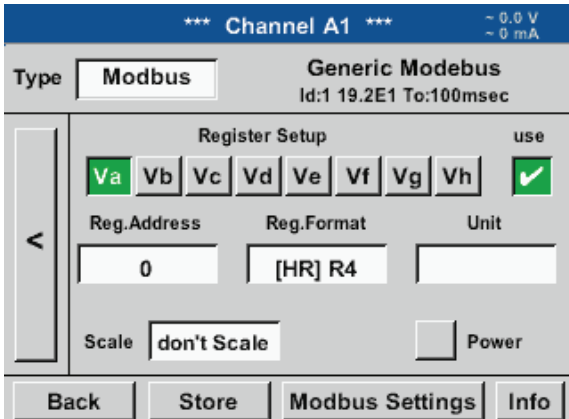

Via Modbus, up to 8 register values (from the input or holding registers) of the sensor can be read out.

Select one or more registers (Va –Vh ) and activate by checking the use box.

#### 11.2.2.10.2. General Modbus settings

Home → Settings → Sensor-settings → A1 → right arrow (2. page) → Modbus settings → ID

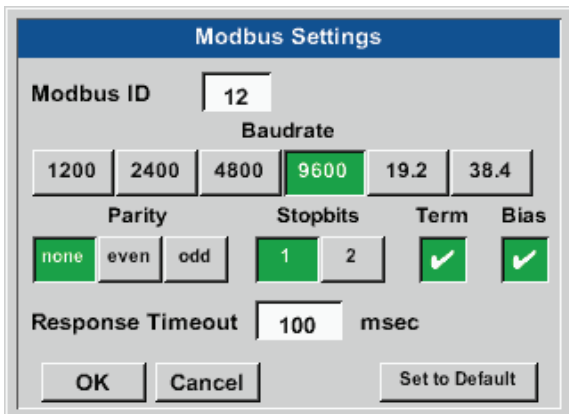

Enter the Modbus ID of the sensor; available values: 1 – 247. (e.g. Modbus ID = 12)

Enter all serial transmission settings such as baud rate, stop bit, parity bit and timeout.

If the METPOINT® BDL compact is connected to the bus terminal, press the Term button to activate termination. You also have the option to press the Bias button to use a BIAS.

Confirm the changes with OK.

To reset the values to the default settings, press the Default values button.

The Modbus ID and the transmission settings are specified in the sensor data sheet.

Home → Settings → Sensor-settings → A1 → right arrow (2. page) → Register address

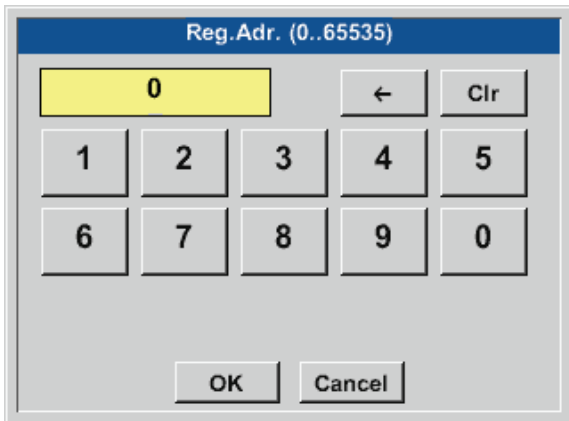

The sensor stores the measured values in registers. These values can be addressed by the BDL and read out via Modbus.

For this purpose, specify the register addresses in the BDL.

The Register/data address is a decimal value between 0 and 65535.

**Important:**

Ensure that the correct Register address is entered. The register address might deviate from the register number (offset). For details, refer to the sensor/transducer data sheet.

Home → Settings → Sensor-settings → A1 → right arrow (2. page) → Register format

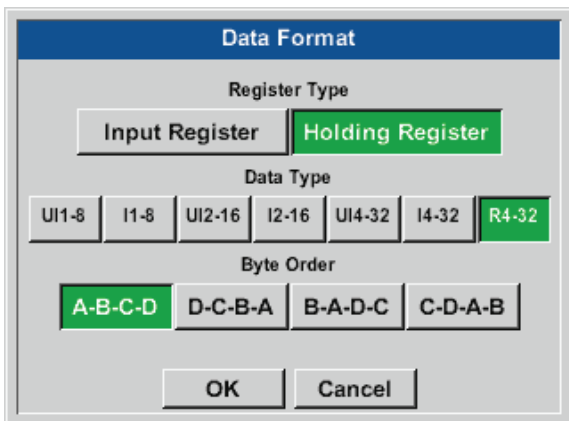

Press the Input register and Holding register buttons, to select the Modbus register type.

Select the Data type and the Byte order. These parameters determine the numerical format and the transmission sequence of the individual numerical bytes.

**Supported data types:**

Data Type:	UI1(8b) = unsigned integer	=>	0	-	255
	I1 (8b) = signed integer	=>	-128	-	127
	UI2 (16b) = unsigned integer	=>	0	-	65535
	I2 (16b) = signed integer	=>	-32768	-	32767
	UI4 (32b) = unsigned integer	=>	0	-	4294967295
	I4 (32b) = signed integer	=>	-2147483648	-	2147483647
	R4 (32b) = floating point number				

**Byte order:**

The Modbus register has a capacity of 2 bytes. For a 32-bit value, two Modbus registers are read by the BDL. For a 16-bit value, only one register is read.

The Modbus specifications do not accurately describe the byte order in which data is transferred. In order to cater for all possible configurations, the byte order can be freely adjusted in the BDL, as it must be adjusted to match that of the respective sensor (see sensor/transducer data sheet).

Example: high byte before low byte, high word before low word, etc.

The byte order must be configured based on the information in the sensor/transducer data sheet.

**Examples:**

Holding register – UI1(8b) - numerical value: 18

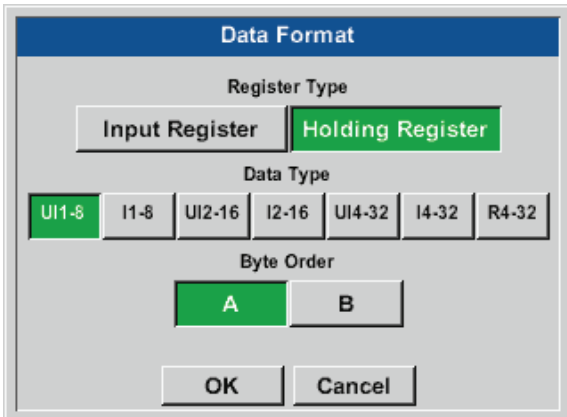

Select register type **Holding register**, data type **U1 (8b)** and byte order **A / B**.

	HByte	LByte
18 =>	00	12
Data Order	1. Byte	2. Byte
A	00	12
B	12	00

Holding register – UI4(32) - numerical value: 29235175522 → AE41 5652

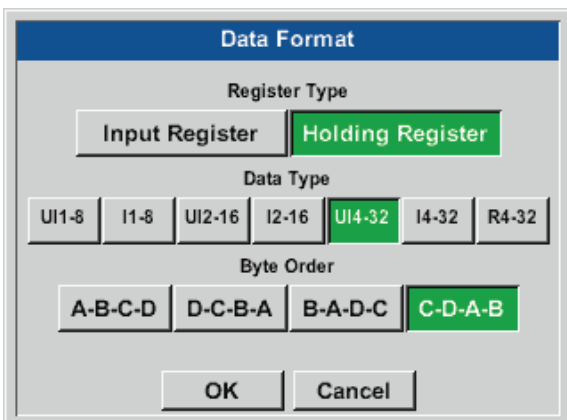

Select register type **Holding register**, data type **U1 (32b)** and byte order **A-B-C-D**.

	HWord		LWord	
	HByte	LByte	HByte	LByte
29235175522 =>	AE	41	56	52
Data Order	1.Byte	2.Byte	3.byte	4.Byte
A-B-C-D	AE	41	56	52
D-C-B-A	52	56	41	AE
B-A-D-C	41	AE	52	56
C-D-A-B	56	52	AE	41

Home → Settings → Sensor-settings → A1 → right arrow (2. page) → Unit

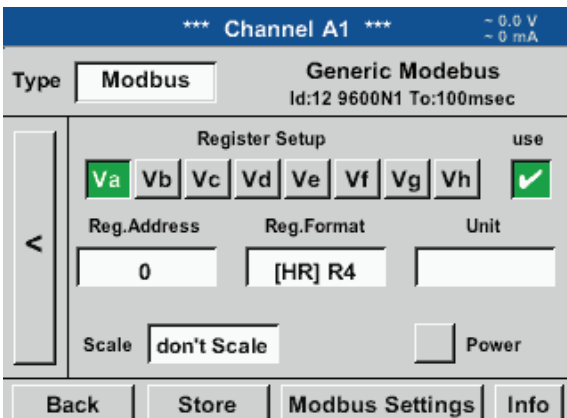

Touch the **Unit** text field to call up a list of the available units.

Select the unit by pressing the respective unit button. Press the **OK** button to apply the unit.

To change between the individual list pages, press the **Page** button.

If the required unit is not available, create it yourself. To do this, press one of the pre-defined **User\_x** buttons.



Home → Settings → Sensor-settings → A1 → right arrow (2. page) → Scal. text field

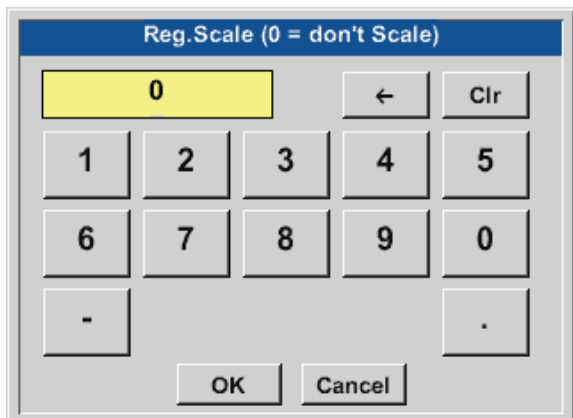

Enter a factor that is applied to adjust the respective output value.

Home → Settings → Sensor-settings → A1 → right arrow (2. page) → OK

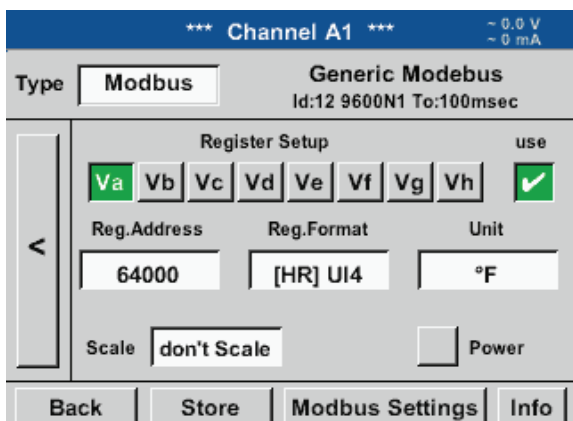

Press the **OK** button to store and apply the user-defined factor.

### 11.2.2.10.3. Modbus settings for METPOINT® SD23

When connecting a METPOINT® SD23 via Modbus, the following settings are required:

**Step 1: select a free sensor channel**

Home → Settings → Sensor settings → Select a free channel (here: channel A1)

**Step 2: select Modbus type**

Home → Settings → Sensor settings → A1 → Type → Modbus and confirm with >OK<.

**Step 3: enter a name**

Home → Settings → Sensor-settings → A1 → Name

Enter a name.

**Step 4: define the Modbus settings**

Home → Settings → Sensor-settings → A1 → right arrow (2. page) → Modbus settings

**Notice:**

Further information on how to configure the text fields, see chapter „11.2.2.7. Labelling and configuring text fields“ page 53.

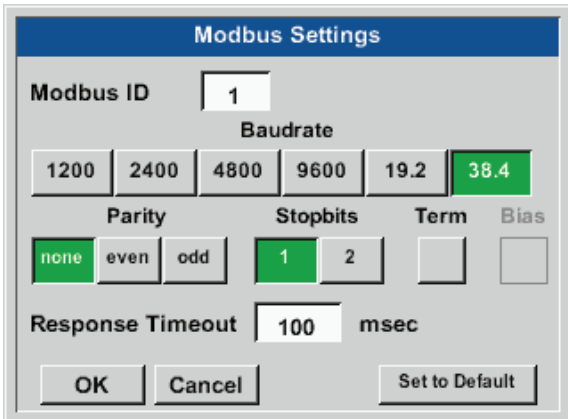

The Modbus ID is specified in the data sheet of the sensor (here: 1).

Adjust the other parameter settings according to the screenshot.

**Step 5: select register**

Home → Settings → Sensor-settings → A1 → right arrow (2. page) → Va → Use

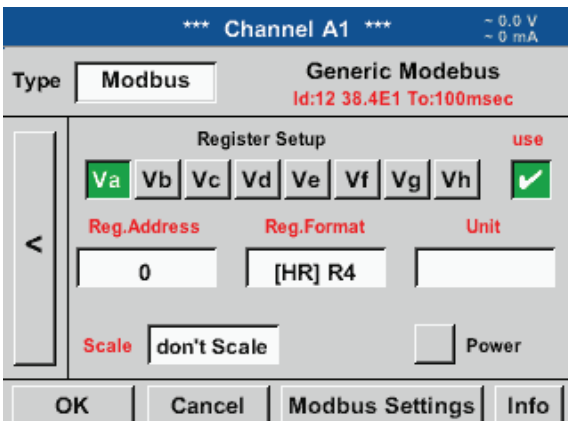

Proceed in the same manner to select the other registers.

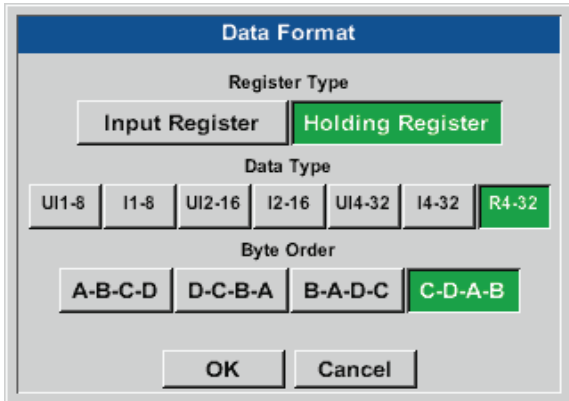

The settings for the register/data format apply to all registers.

**Step 6:**

enter Modbus parameters

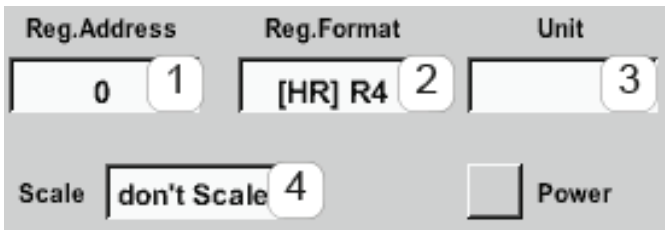

To enter the Modbus parameters, press the white buttons (1) – (4).

The following parameters can be retrieved from the respective registers:

Register	Designation	Register address	Register format	Unit	Scal.
Va	Temperature	1216	[HR]R4	°C	No scal.
Vb	Rel. humidity	1152	[HR]R4	%rH	No scal.
Vc	Dew point/frost point	1536	[HR]R4	°C t <sub>d</sub>	No scal.
Vd	Dew point	1472	[HR]R4	°C t <sub>d</sub>	No scal.

**11.2.3. Device settings**

Home → Settings → Device settings

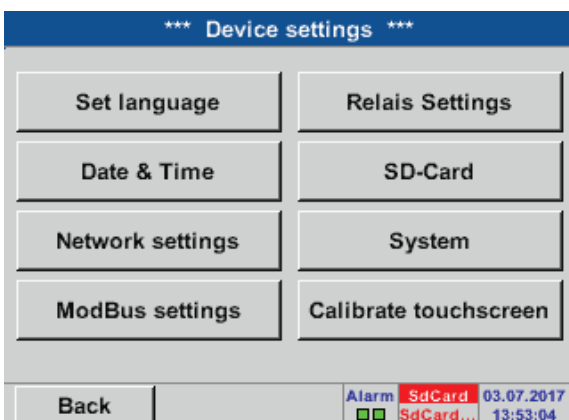

Overview of device settings

### 11.2.3.1. Language

Home → Settings → Device settings → Language

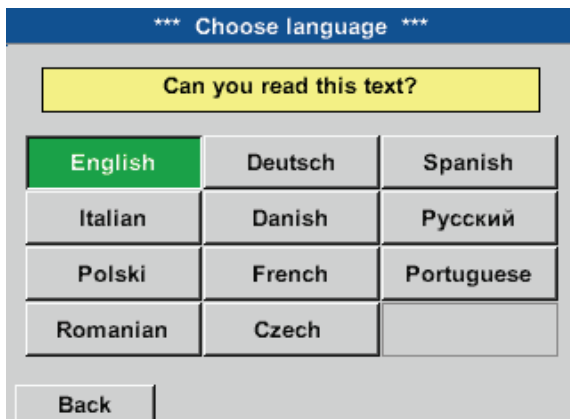

Select the language for the METPOINT® BDL compact interface.

### 11.2.3.2. Date and time

Home → Settings → Device settings → Date & time

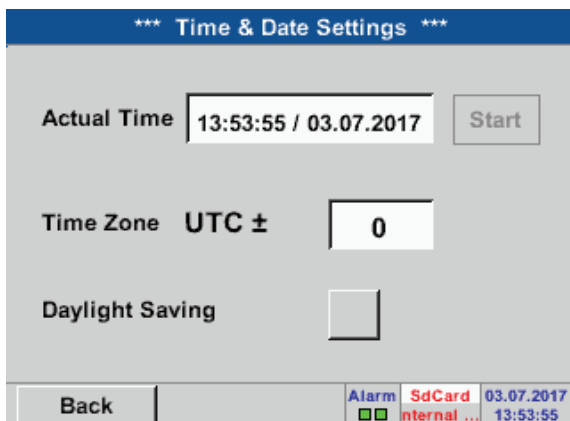

Touch the **Time zone** field and enter the correct **UTC**.

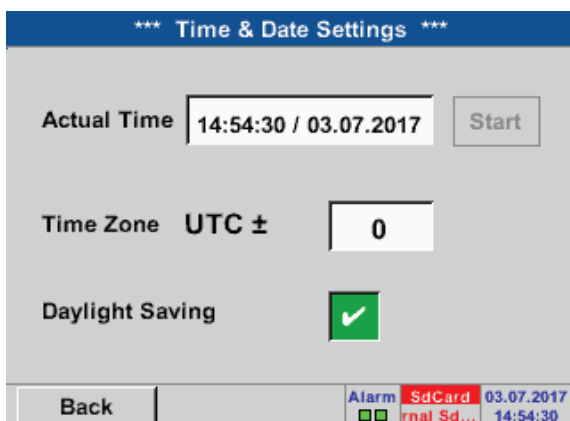

To cater for daylight saving time, check the **Daylight saving** box.

### 11.2.3.3. Network settings

Home → Settings → Device settings → Network settings

\*\*\* Network settings \*\*\*

IP address via DHCP

IP address	Subnet Mask
0.0.0.0	0.0.0.0
Gateway address	DNS address
0.0.0.0	0.0.0.0
Host name	HTTP Port
D4-0000	0
WebAdmin Password	1234

Back      Apply & Restart

Here, a connection to a computer can be configured, with or without DHCP.

**Notice:**

If the DHCP box is ticked, the BDL is automatically integrated into the existing network. In this case, there is no need to manually configure the network settings.

192 · 168 · 0 · 0

1	2	3	4	5
6	7	8	9	0

OK      Cancel

Alternatively, enter the relevant network settings in the fields: Touch the IP address field. An input window is displayed where the relevant entries can be made in the yellow box. Touch the Host name field to enter or change the host name.

Enter the Subnet mask and Gateway address in the respective fields. (For Host name, see chapter 11.2.2.7 Labelling and configuring text fields.)

\*\*\* Network settings \*\*\*

IP address via DHCP

IP address	Subnet Mask
192.168.100.2	255.255.255.0
Gateway address	DNS address
192.168.100.1	200.210.100.4
Host name	HTTP Port
D4-0000	80
WebAdmin Password	1234

Back      Apply & Restart

For the IP address, observe the IP address classes.

Notice:

- Private address range in class A networks: 10.0.0.0 to 10.255.255.255
- Private address range in class B networks: 172.16.0.0 to 172.31.255.255
- Private address range in class C networks: 192.168.0.0 to 192.168.255.255

Subnet mask: e.g. 255.255.255.0



### 11.2.3.4. Modbus (Slave)

The *RS485 Modbus* bus/interface allows customers to connect their own systems (BMS, PLC, SCADA) to the METPOINT® BDL compact.

Home → Settings → Device settings → Modbus settings

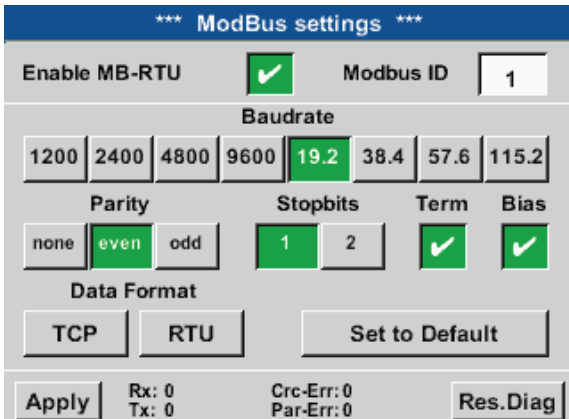

Enter the transmission parameters for **Modbus ID**, **baud rate**, **stop bit** and **parity**. To activate Modbus, check the "Enable Modbus RTU(RS485)" box.

To reset the values to the default settings, press the **Restore defaults** button.

Default values:	Baud rate:	19200
	Stop bit:	1
	Parity:	even

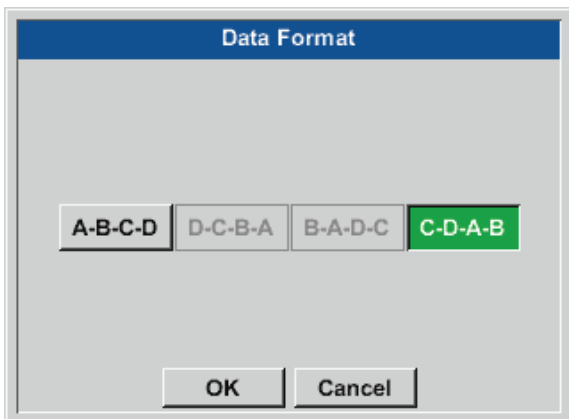

If the METPOINT® BDL compact is connected to the bus terminal, press the **Term** button to activate termination. You also have the option to press the **Bias** button to use a BIAS.

To change the data format (word order), press the **TCP** or **RTU** button.

Default for both modes: C-D-A-B

Changes must always be confirmed with **apply!**

### 11.2.3.5. Relay settings

Home → Settings → Device settings → Relay settings

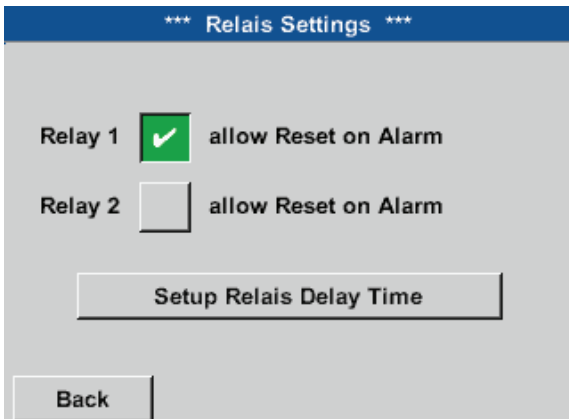

If the **Relay** buttons are activated, you have the option to permit relay reset upon an alarm.

The relevant settings must be made in the password-protected **Device settings** menu.



In the event of an alarm (e.g. alarm 1 (yellow), channel A1), a message is displayed.

If you have permitted relay reset in the **Relay settings**, you can reset the relay by pressing the **Relay 1** button.

Press the **OK** button to close the message box.

### 11.2.3.6. SD card

Home → Settings → Device settings → SD card → Reset Logger database

Home → Settings → Device settings → SD card → Erase SD card

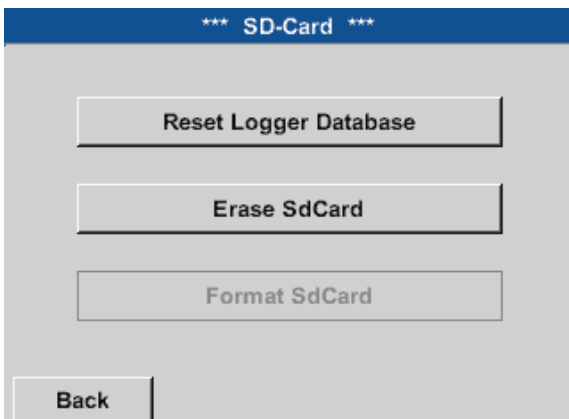

To lock the currently stored data for use by the BDL compact, press the Reset logger database button. The data remains stored on the SD card and is thus available for external use.

To delete all data from the SD card, press the Erase SD card button.

### 11.2.3.7. System

Home → Settings → Device settings → System

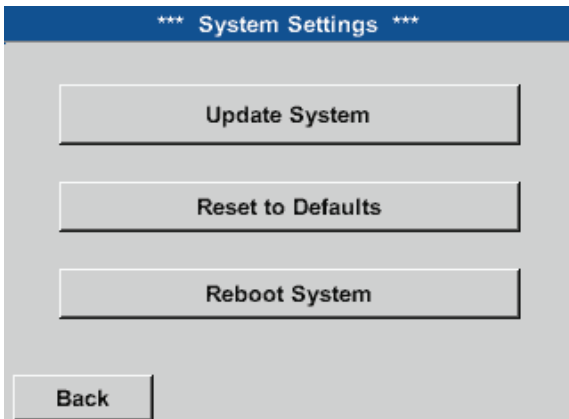

Overview of system settings

**Important:**

Before carrying out an update, save the device settings to a USB memory stick!

**Notice:**

The yellow field shows the update options that are available.

#### 11.2.3.7.1. System update

Home → Settings → Device settings → System → System update

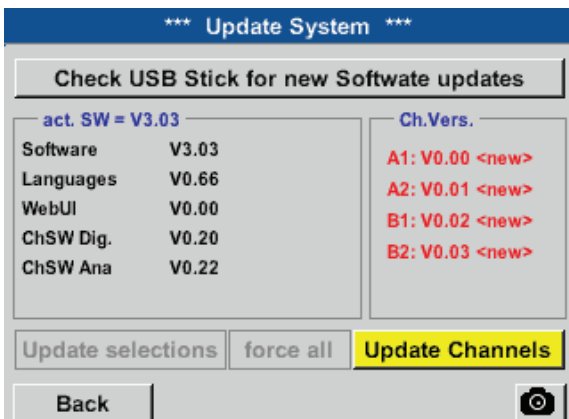

Overview of System update functions

### 11.2.3.7.2. Saving device settings

Home → Export/Import → Export system settings

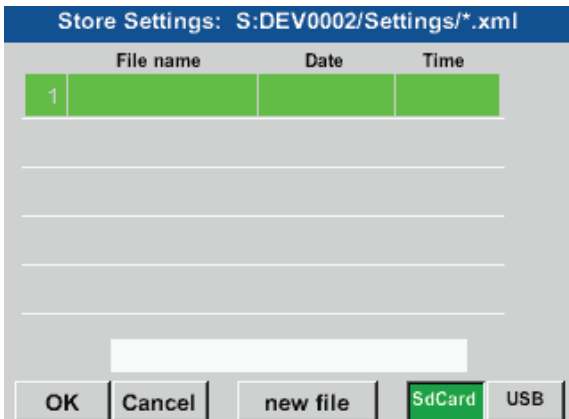

Pressing the **SdCard** or **USB** button sets the storage medium.

Home → Export/Import → Export system settings

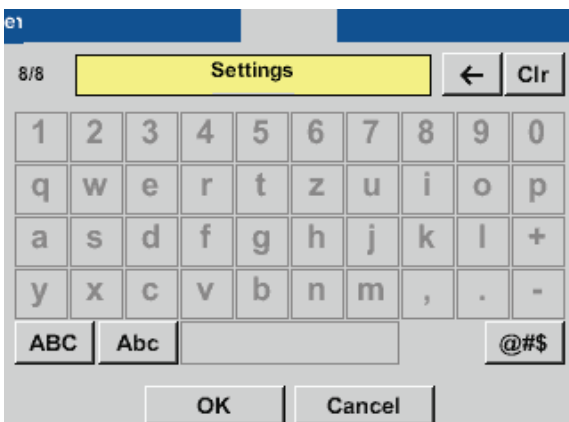

Pressing **new file** will initiate saving.

It is possible to enter a name with up to 8 characters.

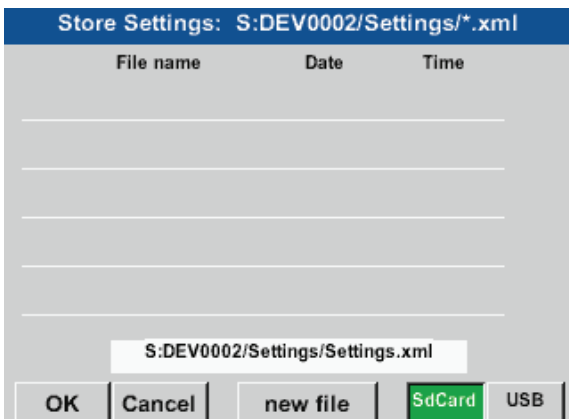

By pressing **OK**, the entries made are accepted and saved.

Saves **Channel and system settings** in XML format to a **SdCard** or **USB** memory stick.

### 11.2.3.7.3. Check for updates (USB)

Home → Settings → Device settings → System → Update system → Check USB stick for new Software updates

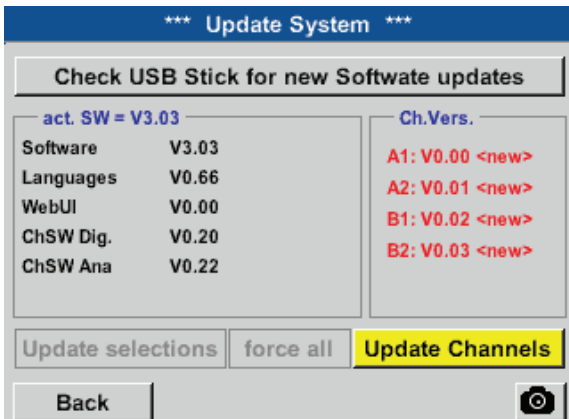

If the USB memory stick is correctly connected to the BDL, the letters change to black and the various available update options (software, pictures, etc.) are shown with a green tick to the left.

To the right, the current (old) and the available (new) versions are displayed.

Home → Settings → Device settings → System → System update → Update selection

**Important:**

If, subsequent to the update, the **Restart** button is displayed, you must press it to restart the BDL!

Home → Settings → Device settings → System → System update → Update channels

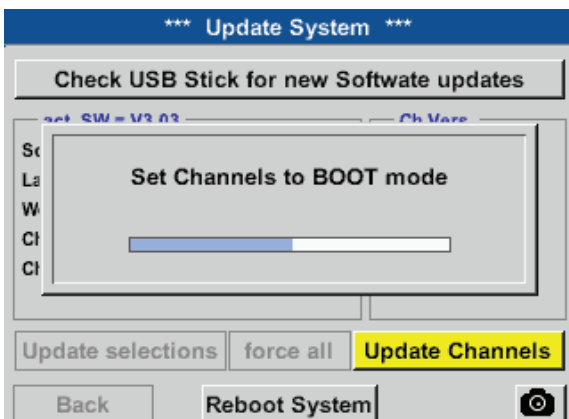

Update for the BDL compact channels.

**Important:**

If, subsequent to the update, the **Restart** button is displayed, you must press it to restart the BDL!

### 11.2.3.7.4. Loading device settings

Home → Export/Import → Import Settings

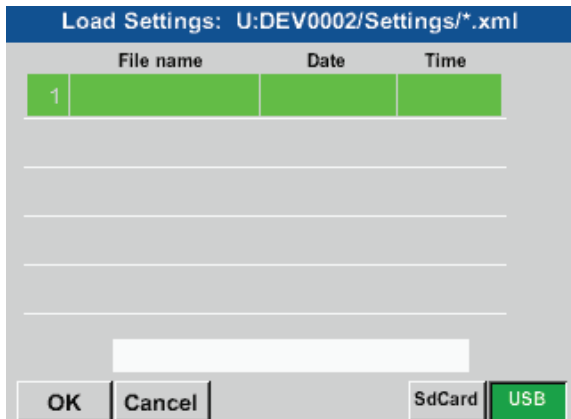

After selecting the storage medium (SdCard or USB), a desired previously saved device setting can be selected and loaded.

**Important:**

After the channel and system settings have been reset, press the **OK** button and then press the **Restart** button to restart the BDL.

### 11.2.3.7.5. Restoring factory settings

Home → Settings → Device settings → System → Reset to Defaults

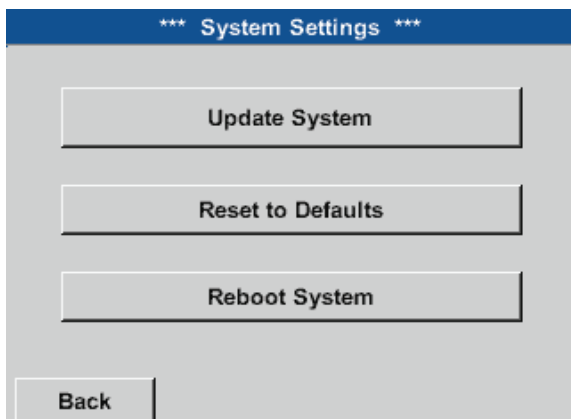

Press the key **Reset to Defaults** setting causes a reset to the factory settings.

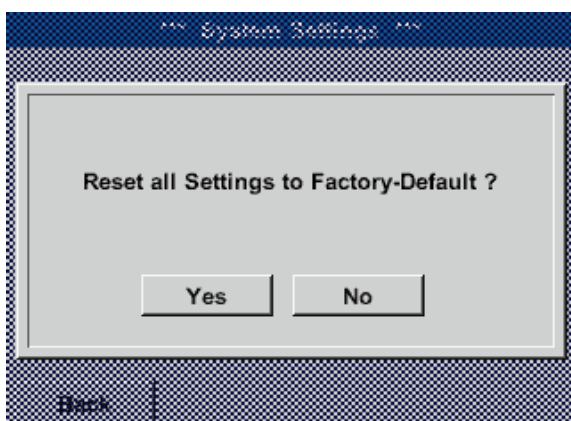

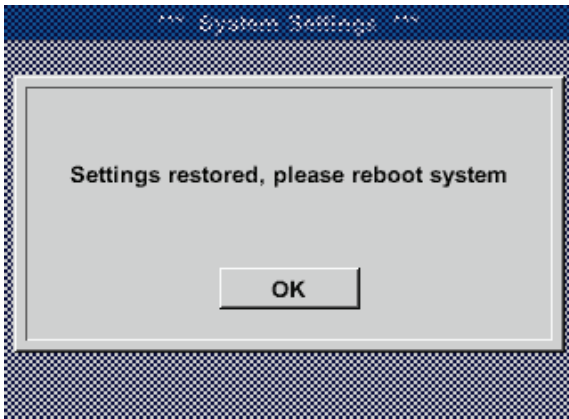

If required, the BDL can be re-booted by pressing the **Restart** button.

### 11.2.3.8. Calibrating touch screen

Home → Settings → Device settings → Calibration touchscreen

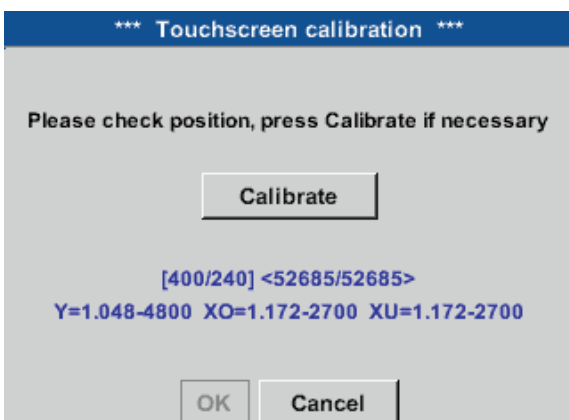

If required, the touch screen calibration can be changed.

Press the **Calibrate** button. A calibration cross appears, first in the top left corner, then in the bottom right corner and finally at the centre of the display. Touch these crosses one after the other.

After calibration has been completed and the display has been properly centred on the screen, confirm with **OK**.

If the display is not centred, repeat the calibration process by pressing the **Cancel** button and then pressing the **Calibrate** button.

### 11.2.4. Backlight

Home → Settings → Set Backlight

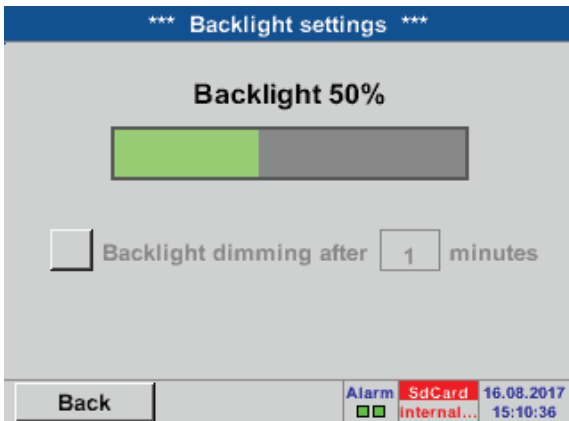

In this menu, you can adjust the Backlight of the display (15 -100%).

Example: Backlight set to 50%

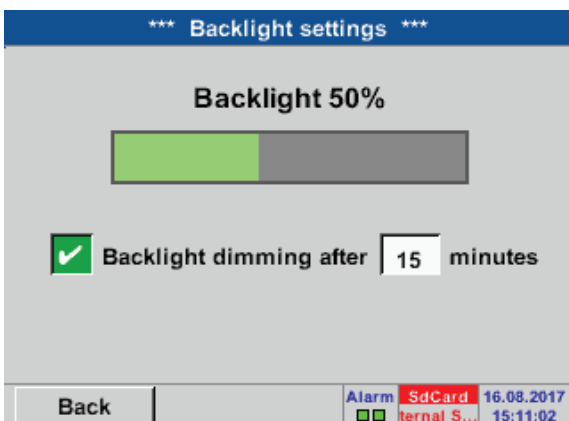

Check the Dim after box to reduce the Backlight to a minimum after the set time interval has elapsed (here: 15 minutes).

As soon as the dimmed screen is activated again, the Backlight automatically returns to the last set value (prior to dimming).

**Notice:**

When the display is touched again, the brightness returns to 50%. Subsequently, the bar works like a normal slider bar.

**Important:**

If the Dim after box is not checked, the panel remains backlit with the currently set brightness.

### 11.2.5. Cleaning

Home → Settings → Cleaning



This function can be used to clean the touch screen while measurements are running. The screen is temporarily disabled for 60 seconds.

If 60 seconds are not sufficient for cleaning, restart the function.

If cleaning is completed before the 60 seconds have elapsed, press and hold the to abort press long button for one to two seconds.



### 11.2.6. System Status

Home → Settings → System Status

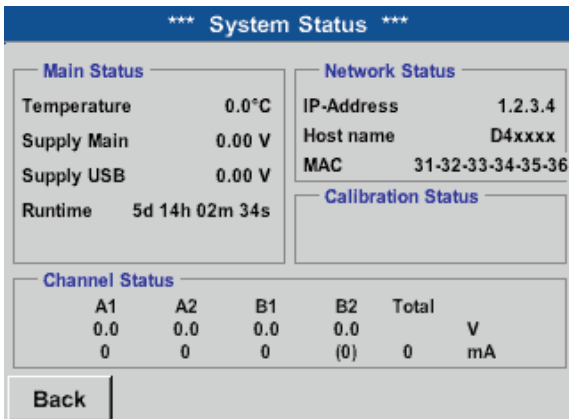

The **System Status** menu provides information on the applied voltages and currents of the individual **Channels**, as well as on the voltage supply of the power supply units. In addition, the most important network parameters such as **IP**, **Host** and **MAC** are displayed. In addition, the total **Operating hours** of the BDL compact are displayed.

### 11.2.7. Virtual channels (optional)

The "Virtual channels" option offers 4 additional channels (no HW channels) for the display of calculations regarding the HW channels, virtual channels, and freely definable constants. For each virtual channel, up to 8 calculations with 3 operands and 2 operations can be configured.

Calculations are used to calculate:

- Specific performance of system
- Total consumption of system (with multiple compressors)
- Energy costs, etc.

For the calculation and display of the "specific performance, see „11.2.7.6. Example: calculation of “specific performance”“ page 84.

#### 11.2.7.1. Activating "virtual channels" option

After having acquired the "Virtual channels" option, you must activate it.

Home → Settings → About BDL compact

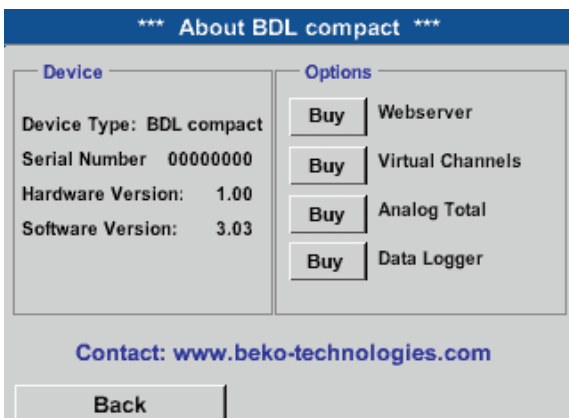

Press the Buy button for "Virtual channels". You are prompted to enter the activation code.

### 11.2.7.2. Virtual channel settings

Home → Settings → Sensor-settings → Virtual channels

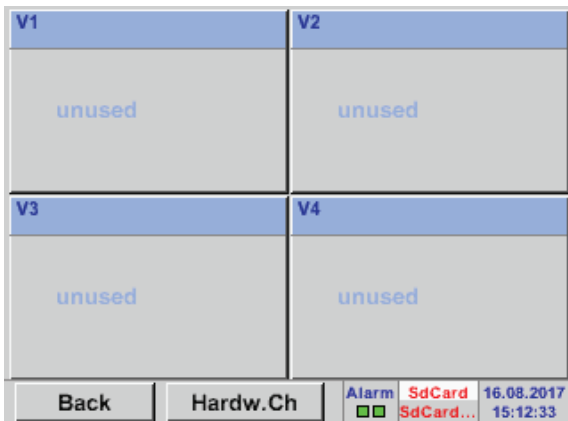

After the **virtual channels** have been activated, the 4 available channels are shown in the sensor settings menu.

**Note:**  
By default, the channels are not preconfigured.

### 11.2.7.3. Selecting sensor type

Home → Settings → Sensor-settings → Virtual channels → V1



If no sensor has been configured yet, **No sensor** is displayed in the type field.

Touch the type field (reading **No sensor**) to call up a list of available sensor types (see next step).

Home → Settings → Sensor-settings → Virtual channels → V1 → Type

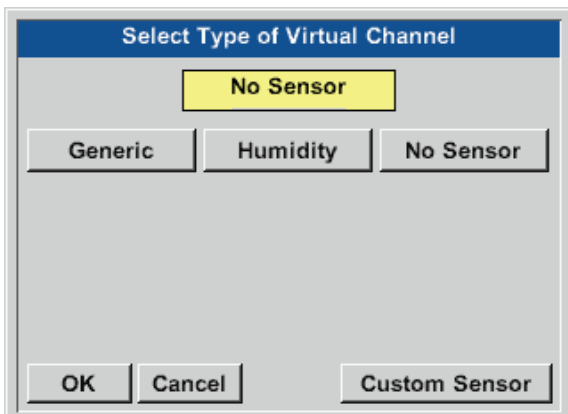

If no sensor has been configured yet, **No sensor** is displayed in the top field.

Pressing the **Generic** to select the virtual channel.  
Press the **No sensor** button to reset the channel.  
Press the **OK** button to confirm the selection.

Home → Settings → Sensor-settings → Virtual channels → V1 → Name



Enter a **Name** for the virtual channel.

### 11.2.7.4. Configuring virtual values

For each virtual channel, up to 8 virtual values can be calculated. These values must be activated separately:

#### 11.2.7.4.1. Activating virtual values

Home → Settings → Sensor-settings → Virtual channels → V1 → right arrow (2. page) → V1a → Use

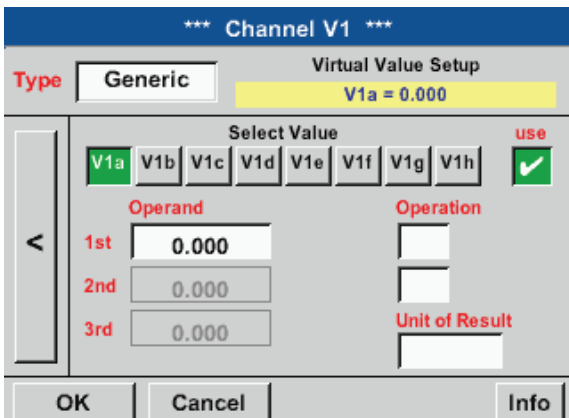

To activate a virtual value, press the respective **Value** button (e.g. **V1a**) and confirm with **OK**.

#### 11.2.7.4.2. Defining operands

Home → Settings → Sensor-settings → Virtual channels → V1 → right arrow (2. page) → 1st operand

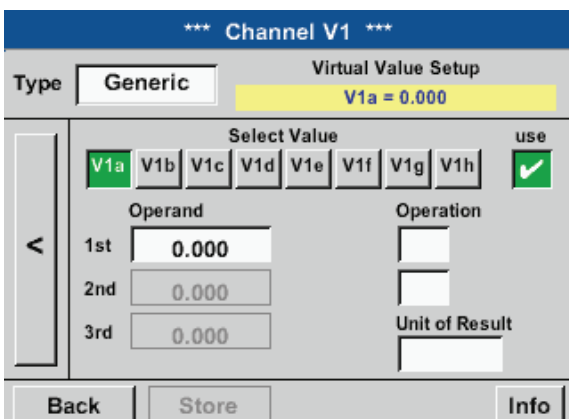

Touch the **1st operand** field. A list of the available hardware channels, virtual channels, and constant values is displayed.

Home → Settings → Sensor-settings → Virtual channels → V1 → right arrow (2. page) → 1st operand → A1

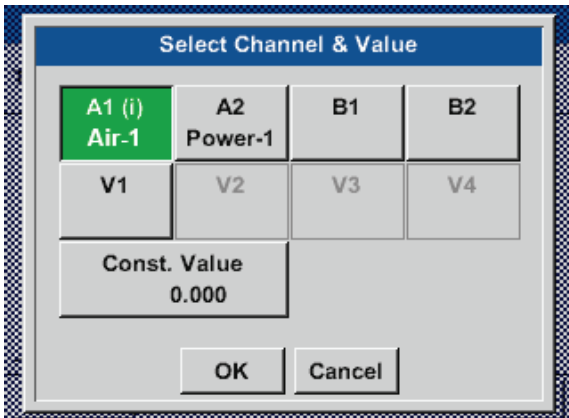

Press a hardware or virtual channel button (e.g. A1) to call up a list of the available measuring channels or measurements including the defined virtual channels.

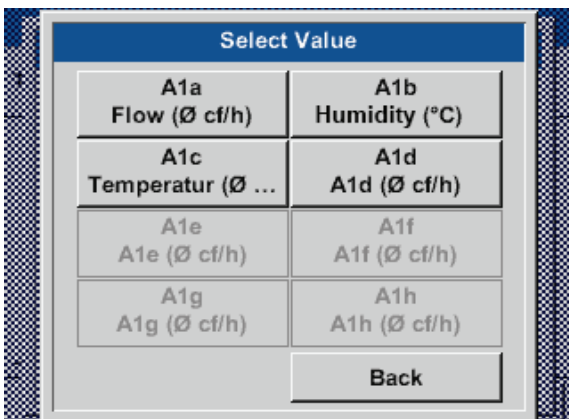

Press a channel button (e.g. A1b) to apply it.

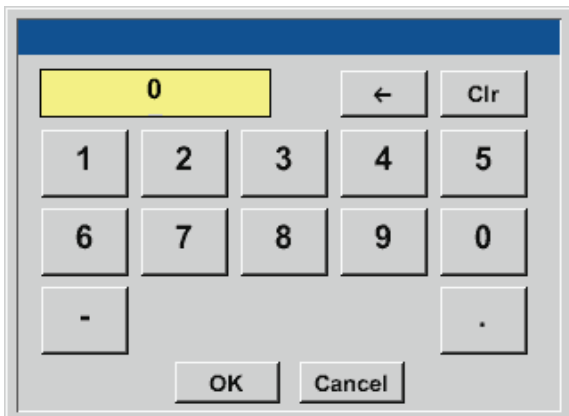

If the **Const. value** button has been pressed, enter the value in the field, using the numerical keypad. Press the **OK** button to apply the value.

To correct a value, press the **<-** and **Clr** button.

The **<-**-button deletes the last character  
The **Clr** button deletes the entire value

The procedure described here applies to all operands (1st operand, 2nd operand, and 3rd operand).

### 11.2.7.4.3. Defining operations

Home → Settings → Sensor-settings → Virtual channels → V1 → right arrow (2. page) → 1st operation



Touch the **1st operation**. The available mathematical operations are displayed.

Press the respective button to select and apply an operation.

To reset a selected operation, press the **not used** button.

The procedure described here applies to all operators (1st operation and 2nd operation)

### 11.2.7.4.4. Defining unit

Home → Settings → Sensor-settings → Virtual channels → V1 → right arrow (2. page) → Unit for result

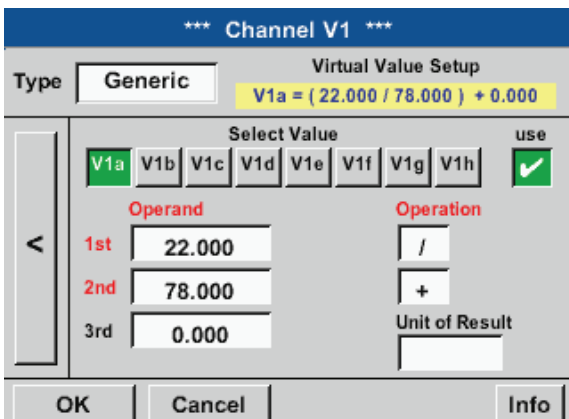

Touch the **Unit** text field to call up a list of the available units.



Select the unit by pressing the respective unit button. Press the **OK** button to apply the selected unit.

To change between the individual list pages, press the **Page** button.

If the required unit is not available, create it yourself.

To do this, press one of the pre-defined **User\_x** buttons.

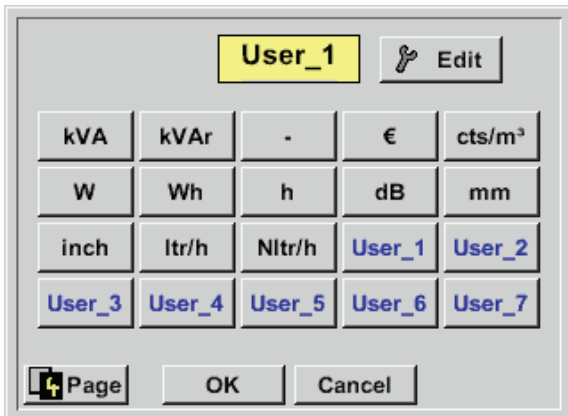

To enter the new unit, press the **Edit** button.

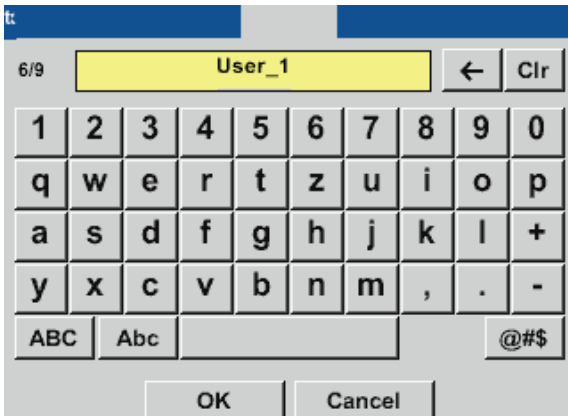

Enter the unit and accept with **OK**.

To correct an entry, press the **<-** or **Clr** button.

The **<-** button deletes the last character  
 The **Clr** button deletes the entire value

**Important:**

After all values and operators have been entered, the system is able to perform calculations with 3 values and 2 operands as follows:

**Example:**

V1a = (1st operand 1st operation 2nd operand) 2nd operation 3rd operand  
 V1a = (A1c - A2a) \* 4.6

### 11.2.7.5. Resolution of decimal places – labelling and recording data values

Home → Settings → Sensor-settings → Virtual channels → V1 → Tool button

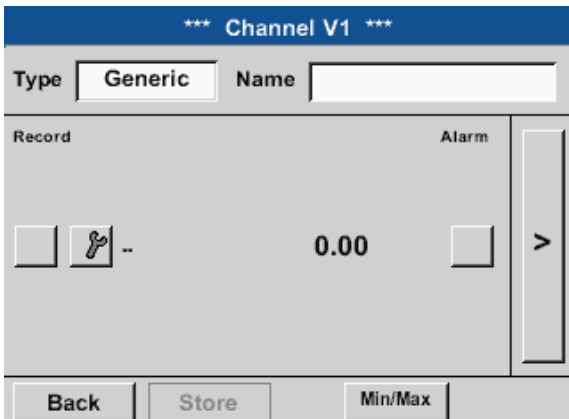

Press the **Tool** button to view the **Resolution** for decimal places, the **Short name** and the **Value name**.

Press the **Record** button to record and store the selected data on the activated data logger.

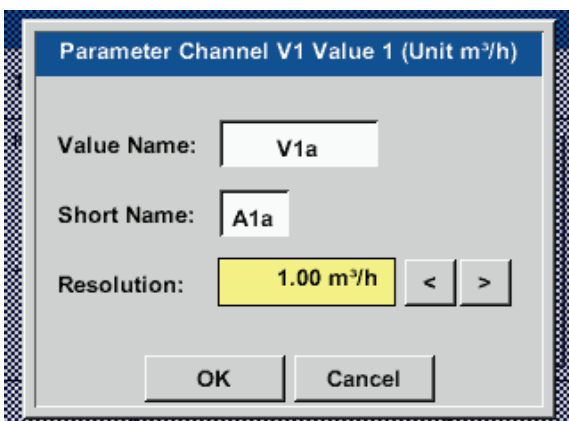

For the **Value** to be recorded, enter a **Name** with max. 10 characters. This name is then used in the **Charts** and **Chart/current values** menus. Otherwise, the default designation (e.g. **V1a**) is displayed.

**V1** indicates the channel; **a** is the first value in the channel, **b** would be the second, and **c** the third. To adjust the **Resolution** of the decimal places, touch the arrow buttons (0 to 5 decimals places).

Home → Settings → Sensor-settings → Virtual channels → V1 → Record button

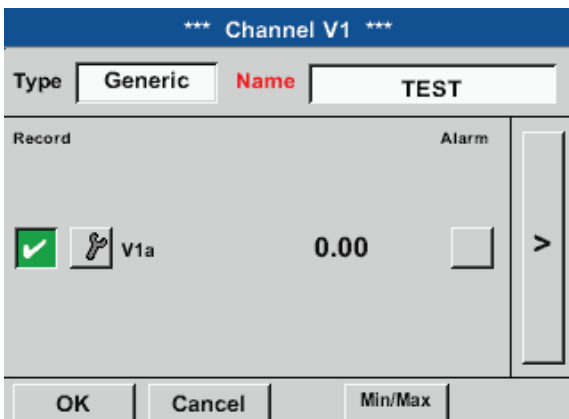

Press the **Record** buttons to select the measurements to be recorded and stored on the activated data logger.

**Caution:**

Prior to recording the selected measuring data, configure the data logger and then start it (see chapter 11.4 Logger settings (data logger)).

See also chapters 11.2.2.2 Labelling measurements and 11.2.2.3 Recording measuring data.

### 11.2.7.6. Example: calculation of "specific performance"

This example is based on a compressor plant with 3 compressors.

The consumption is measured with an FS109 consumption probe at inputs A1 - B1, and an electricity meter at input B2.



The total consumptions for air and energy, and the "specific performance" of the entire plant are calculated.



Home → Settings → Sensor settings → Virtual channels → V1 → right arrow (2. page) → V1a → Use

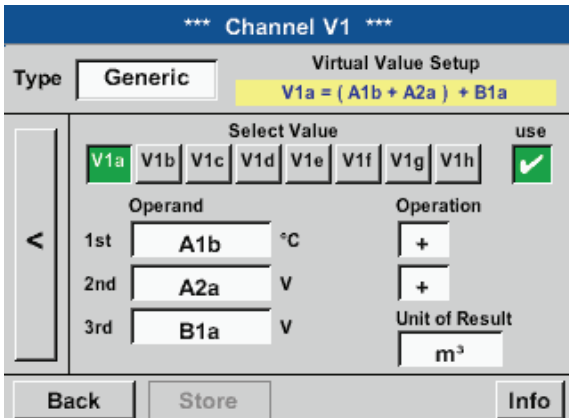

For instructions regarding the input of the operands and operations, see chapters „11.2.7.4.2. Defining operands“ page 79 and „11.2.7.4.3. Defining operations“ page 81.

The result for V1a is the sum of consumption sensors A1 + A2 + A3 (see result panel). In this example, it is 66090.2 m³

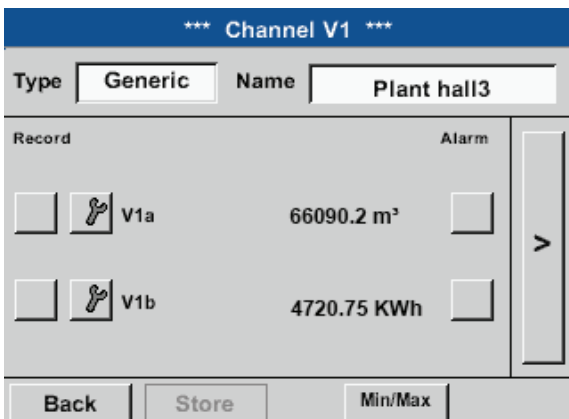

V1b is the power consumption as measured by the power meter.  
V1a → total compressed air consumption  
V1b → power consumption

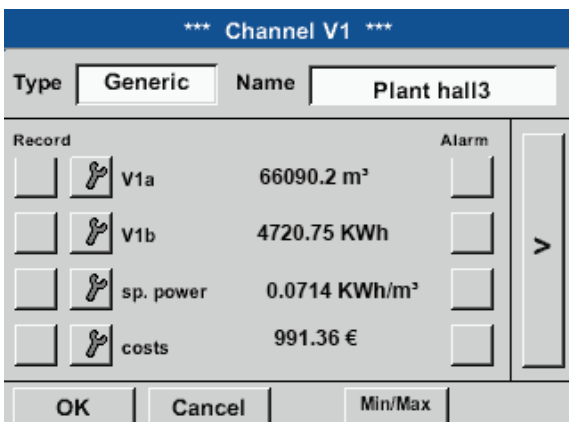

The Specific performance is calculated as follows:  
 $V1c = V1b / V1a = 0.072 \text{ kWh/m}^3$

The total costs are calculated as follows:  
 $V1d = B2 * 0.21 = € 991.36$

Calculation of energy costs per m³ air:  
 $V1e = V1c * 0.21$

As there are more than 4 values used in this virtual channel, the display is split. To change between the screens, press the Page button.

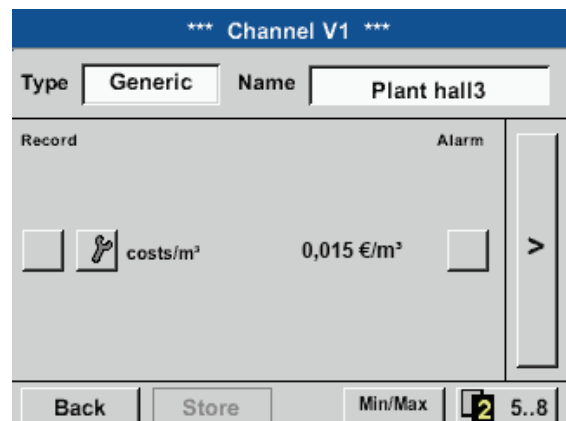
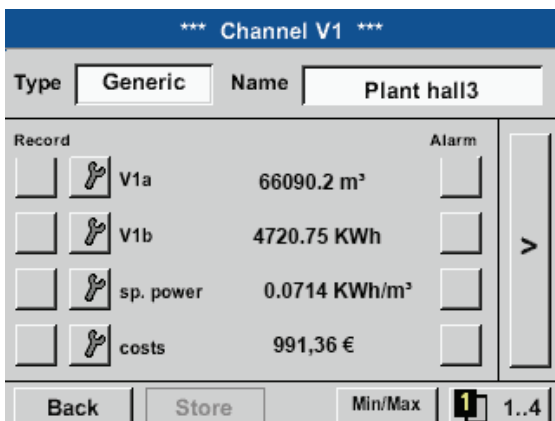

## 11.2.8. Analog total (optional)

The "Analog total" option allows you to calculate the consumption based on sensors with analog outputs, e.g. 0-1/10/30 V or 0/4 – 20 mA.

### 11.2.8.1. Activating "Analog total" option

After having acquired the "Analog total" option, you must activate it.

Home → Settings → About BDL compact



Press the **Buy** button for virtual channels. You are prompted to enter the activation code.

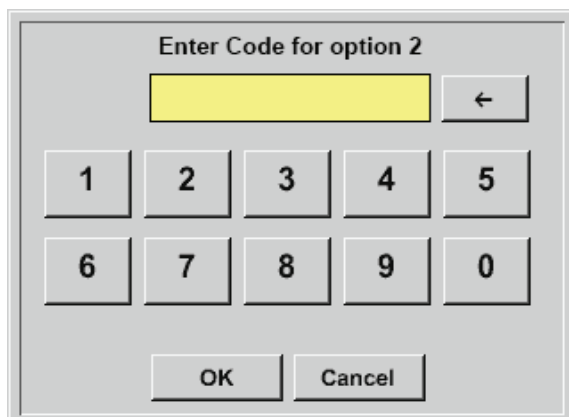

Enter your activation code and press the **OK** button.

### 11.2.8.2. Selecting sensor type

See also chapter 11.2.2.8 Configuring analog sensors

Home → Settings → Sensor settings → B1



If no sensor has been configured yet, **No sensor** is displayed in the type field.

Touch the type field (reading **No sensor**) to call up a list of available sensor types (see next step).

Home → Settings → Sensor-settings → B1 → Type

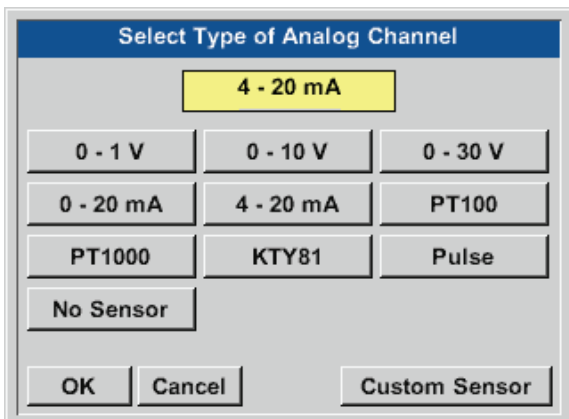

Select the required sensor type by pressing the respective button (here: 4-20 mA).

Confirm with **OK**.

Home → Settings → Sensor-settings → B1 → right arrow (2. page)

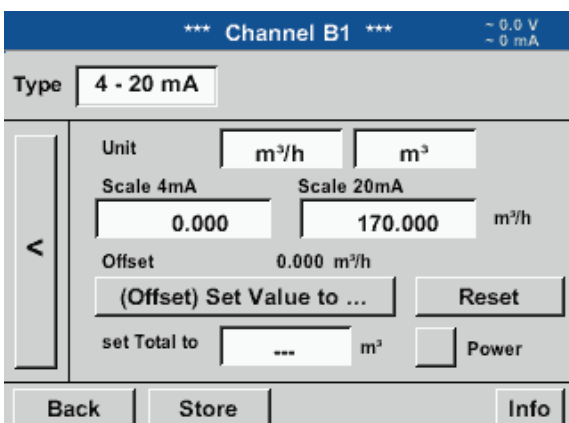

Select the units by touching the **Unit**, **Measured value** or **Consumption** field.

Enter scaling values for 4 mA and 20 mA (here: 0 m³/h and 170m³/h).

If required, enter the start value for consumption (counter value) in the **Set total to** field.

Confirm with **OK**.

**Notice:**

The "Consumption unit" field can only be edited, if the unit of the measurement is a consumption unit, i.e. unit for a volume over time.

For the labelling and configuration of the text fields, see chapter 11.2.2.7 Labelling and configuring text fields.

### 11.3. Web server (optional)

After having acquired the "web server" option, you must activate it.

#### 11.3.1. Activating web server option

Home → Settings → About BDL compact



Press the **Buy** button for "Analog total". You are prompted to enter the activation code.

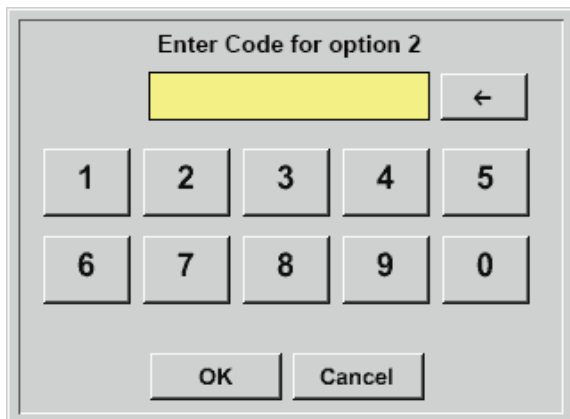

Enter your activation code and press the **OK** button.

The following options can be viewed in Internet Explorer by entering the IP address of the BDL compact.

http:// <IP address of BDL compact>

**Notice:**

For the IP address of the BDL compact, see chapters „11.2.3.3. Network settings“ page 68.

## 11.3.2. User interface

The user interface can be called up with any conventional web browser. To call up the user interface, enter the IP address of the web server in the address bar of the web browser (e.g. <http://172.16.4.56>).

The start page is the information page.

### 11.3.2.1. Information

This page shows all relevant system information of the METPOINT® BDL in the form of a table.

The screenshot shows the web interface for the METPOINT® BDL. At the top, there is a blue header with the BEKO logo on the left, the text 'BDL the quality of your compressed air' in the center, and the date '18.3.2016 - 09:22:30', 'Visits: 11', 'User: admin', and 'Logout in: 8:34' on the right. Below the header, there is a navigation menu on the left with options like 'Info', 'Favourites', 'Status', 'Actuals', 'Screen', 'Chart', 'MailOnAlarm', 'Users/Passw.', and 'EMail Config.'. The main content area is titled 'System Information' and contains a table with the following data:

System Information	
Brandname	BDL
Company	BEKO TECHNOLOGIES
Serialnumber	06140407
Hardware Version	V0.00
Software Version	V4.07
Channel Version	V0.05
Language Version	V1.66
WebUI Version	V1.06
Total Channels	12
Hostname	BDLHQBEC
Calling IP	172.16.26.141
Logger State	run
Alarm State	OK

Designation	Description
Series/brand name	Device product name
Company	Device manufacturer
Serial number	Serial number of device
Hardware version	Current hardware version
Software version	Current software version
Channel version	Current channel version
Language version	Current language versions
WebUI version	Current version of web interface (WebUserInterface)
Total number of chanel	Number of available channels at METPOINT® BDL
Host name	Network name of METPOINT® BDL - see also chapter 11.2.3.3 page 68
Called from IP	IP address of PC from which the web server is accessed
Logger status	Current status of data logger
Alarm status	Current alarm status

### 11.3.2.2. Selecting language

The web server user interface language is factory-set to German. If required, choose a different language from the dropdown list <sup>1</sup>.

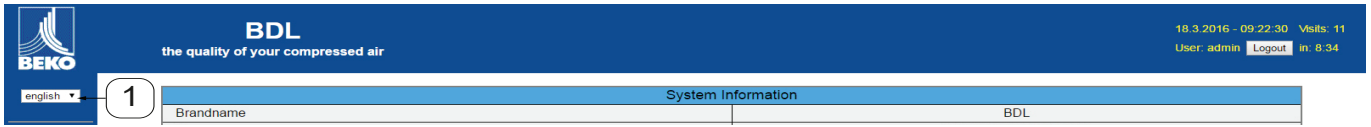

Available languages:

- German
- English

<b>NOTICE</b>	Restriction of access
	Access to certain menu options is restricted. To have read and write access to all settings, you must log in <sup>2</sup> as Administrator and enter the password specified in „11.3.3. Login“ page 90 (e.g. 1234). For the configuration of additional users, call up the User menu, see chapter 11.3.10 page 96.

### 11.3.3. Login

To log in to the web server, press the >>Login<< <sup>1</sup> button.

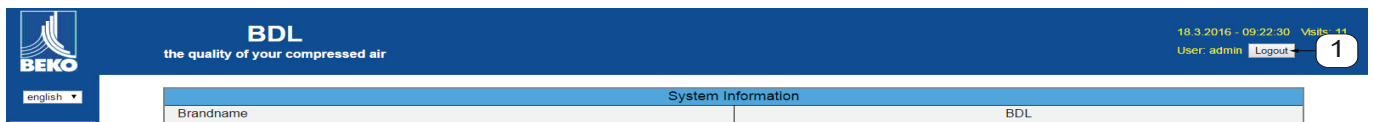

To be read and write access to all settings, you must log in as Administrator.

**Login**

Username

Password

User name: admin  
Password: e.g. 1234

<b>NOTICE</b>	<b>Restriction of access</b>
	For the configuration of additional users and access rights, call up the User menu, see chapter 11.3.10 page 96.

### 11.3.4. Favourites

This menu provides access to 4 user-defined web pages (favourites) that can be configured for the display of measurements. This menu is accessible without prior login.

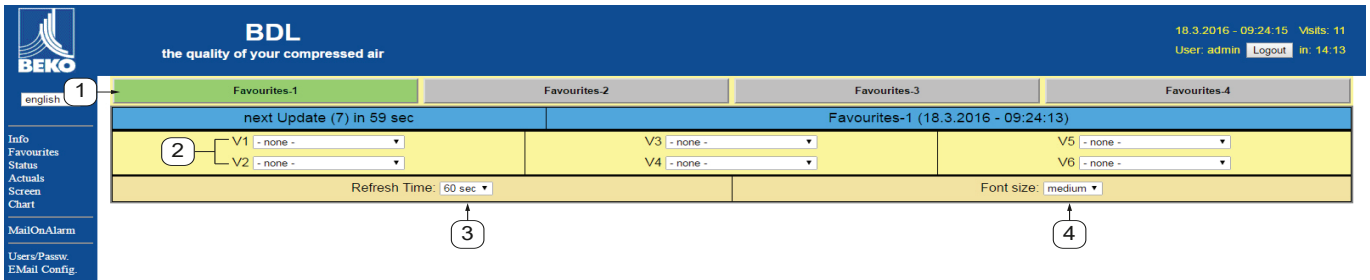

No.	Description
1	Select user-defined page (favourite)
2	Select channels and measurements to be displayed
3	Select update interval for display
4	Select font size for measurements

### 11.3.5. Status

The status menu shows the statuses of the individual relays and the data logger.

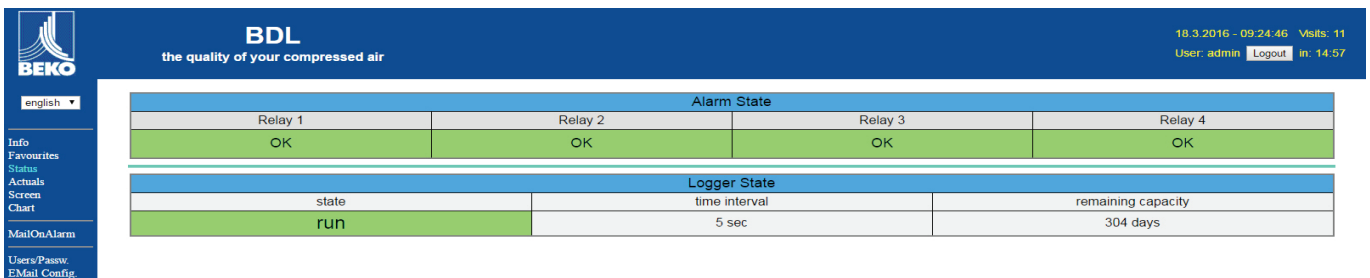

### 11.3.6. Current value

This menu shows the current measurements transmitted by the connected sensors. You have the option to narrow the overview down to selected sensors and measurements.



**BDL**  
the quality of your compressed air

18.3.2016 - 09:25:16 Visits: 11  
 User: admin Logout in: 14:58

next Update (1) in 59 sec

Actual Values (18.3.2016 - 09:25:14)

show Sensors				show Values				
Channel	Value 1	Value 2	Value 3	Value 4	Value 5	Value 6	Value 7	Value 8
S1 (A1) dew point KAT in	A1a 23.51 °C	A1b 8.05 %RH	A1d -12.58 °Ctd	—	—	—	—	—
S2 (A2) pressure KAT in	A2a 0.06 bar	—	—	—	—	—	—	—
S3 (A3) pressure KAT out	A3a 0.07 bar	—	—	—	—	—	—	—
S4 (A4) dew point KAT out	A4a 23.12 °C	A4b 6.91 %RH	A4d -14.75 °Ctd	—	—	—	—	—
S5 (B1) pressure x.x.x	B1a 9.019 bar	—	—	—	—	—	—	—
S6 (B2) oil vapor	B2a 0.0003 mg/m³	—	—	—	—	—	—	—
S7 (B3) flow x.x.2	B3a 73.270 m³/h	B3b 109968 m³	B3c 45.992 m/s	—	—	—	—	—
S8 (B4) flow x.x.1	B4a 10.689 m³/h	B4b 34628 m³	B4c 6.710 m/s	—	—	—	—	—
S9 (C1) dew point x.x.2	C1a 22.60 °C	C1b 26.87 %RH	C1c 2.66 °Ctd	—	—	—	—	—
S10 (C2) pressure x.x.2	C2a 8.82 bar	—	—	—	—	—	—	—
S11 (C3) dew point x.x.1	C3a 22.58 °C	C3b 29.38 %RH	C3c 3.90 °Ctd	—	—	—	—	—
S12 (C4) pressure x.x.1	C4a Range 7 bar	—	—	—	—	—	—	—
S13 (V1) V12	Verbrauch 144596 m³	Kosten 2602.73 €	—	—	—	—	—	—
S14 (V2) delta P KAT	0.00 bar	—	—	—	—	—	—	—
S15 (V3) delta P Production hall	0.20 bar	—	—	—	—	—	—	—

3 → Refresh Time: 60 sec ▼

4 → Font size: tiny ▼

No.	Description
1	Select sensors to be displayed
2	Select measurements to be displayed
3	Select update interval for display
4	Select font size



### 11.3.7. Display

The menu shows the current METPOINT® BDL GUI and enables you to configure the BDL. The display is automatically updated every 60 seconds. It is thus not a real-time display.

The screenshot displays the BEKO BDL web interface. At the top, it shows the BEKO logo and the text 'BDL the quality of your compressed air'. The main content area is titled 'Actual MMI-Screen (18.3.2016 - 09:26:20) \*\*\* BEKO TECHNOLOGIES \*\*\* BDL \*\*\*'. It features a central menu with buttons for 'Chart', 'Alarm overview', 'Chart/Real time values', 'Consumption report', 'Channels', 'Import / Export', and 'Real time values', 'Settings'. Below this is a status bar with 'Shutdown', 'Alarm' (green), 'Log run' (green), 'val = 5 sec', and the date '18.03.2016 09:26:17'. A bottom navigation bar contains buttons for 'Chart/RT', 'Channels', 'Realtime', 'Alarm', 'Report', and 'Settings'. Below the navigation bar are two tables: 'Alarm State' and 'Logger State'. The 'Alarm State' table shows four relays (Relay 1 to Relay 4) all in 'OK' status. The 'Logger State' table shows 'state' as 'run', 'time interval' as '5 sec', and 'remaining capacity' as '304 days'. Numbered callouts 1 through 4 point to the main menu area, the bottom navigation bar, the Alarm State table, and the Logger State table respectively.

No.	Description
1	Current METPOINT® BDL touch screen display
2	Buttons for the operation and configuration of the METPOINT® BDL
3	Current alarm status of relays
4	Current status of data logger

Press the buttons ② to change the settings as if you were operating the BDL on site.

### 11.3.8. Chart

This menu is used to view charts. All measurements stored on the SD card can be displayed in the form of charts.

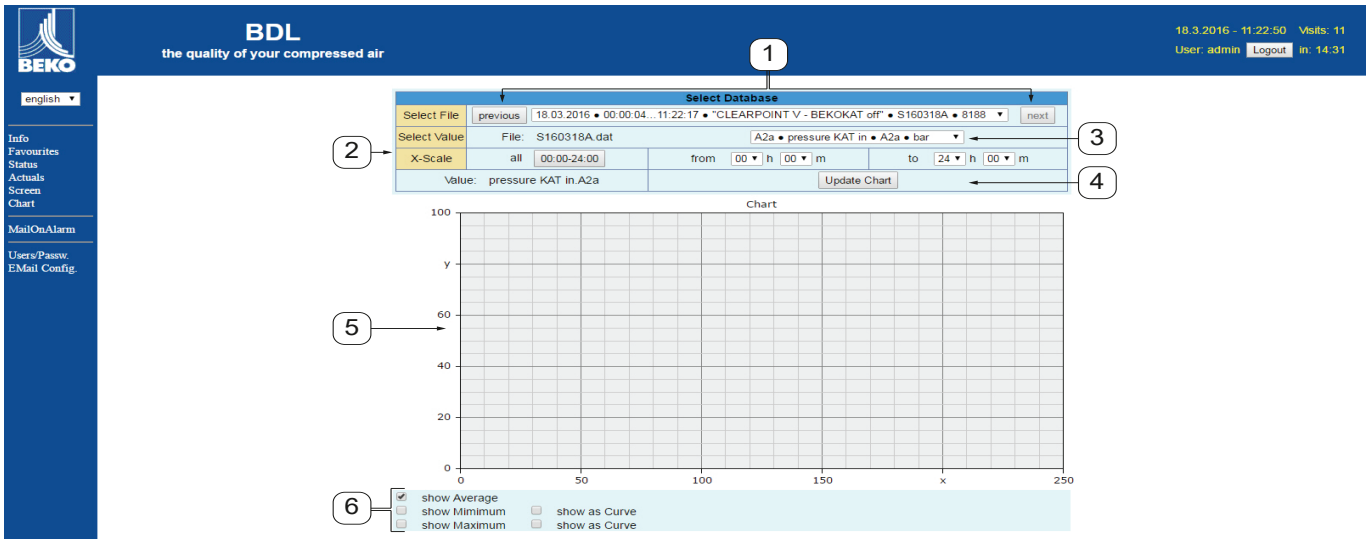

No.	Description
1	Selection of measurements stored on the SD card Press the >>previous<< and >>next<< to move to the previous/next data record
2	Period for the display of the measurements
3	Select channel to be displayed
4	Draw chart for selected channel
5	Chart plotting area
6	Select measurements to be displayed

### 11.3.9. AlarmMail

This menu allows you to have e-mail alerts sent to certain e-mail addresses, if a limit value is exceeded.

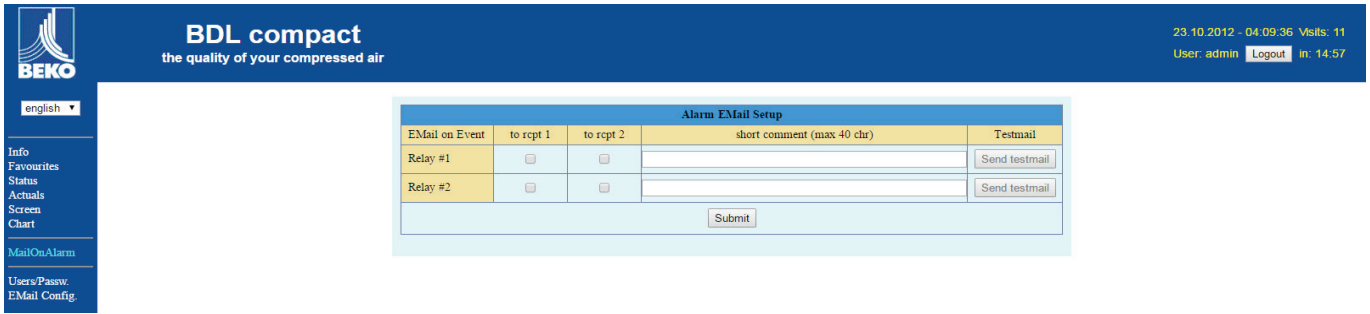

The content of the message is preset, but you can add a brief comment.

## BDL ALARM

Event: 12.06.2012 18:14:57  
 IP: 172.16.4.142  
 Hostname: BDL-PMA

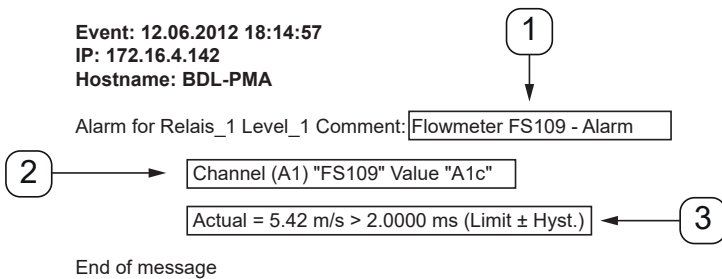

No.	Description
1	Brief comment re. alert
2	Channel and measurement
3	Measured value and respective alarm limit

<b>NOTICE</b>	<b>Setting up alarm mail recipients</b>
	For information on how to configure alarm mail recipients, see User menu, chapter 11.3.10 page 96.

### 11.3.10. User

In this menu, you can configure the users of the web server and define their access rights.

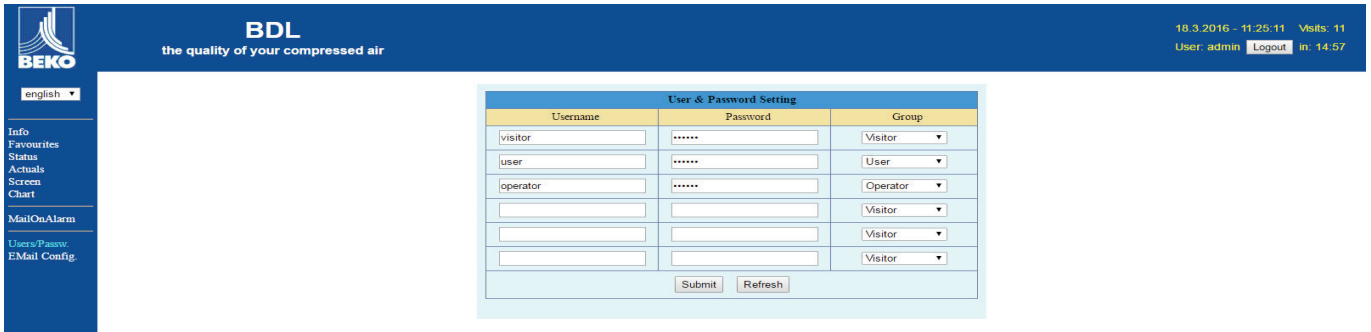

The access rights are assigned to user groups. The available user groups are listed in the table below:

User groups	Access rights					
	Info	Status	display	Chart	AlarmMail	User/mail recipient management
no login	X					
Guest	X	X	X			
User	X	X	X	X		
Operator	X	X	X	X	X	
Administrator	X	X	X	X	X	X

**Available:**

min. 4 characters; max. 12 characters

No special characters

### 11.3.11. EMail

This menu is used to set up e-mail recipients for alarm mails. You also have the option to test the e-mail alert function. For configurations, consult your IT department.

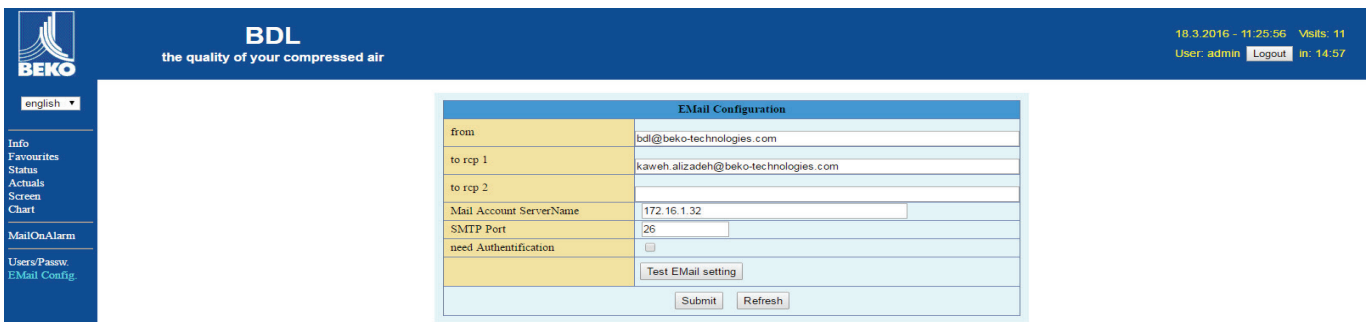

Press the >>Test e-mail settings<< button to call up a browser window showing the process of the test.

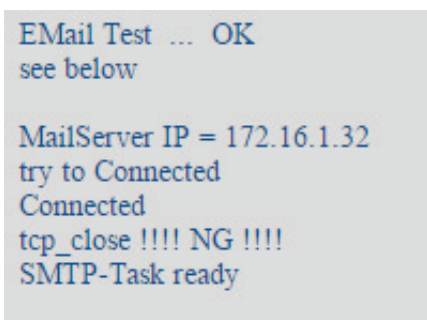

Successfully completed e-mail test

### 11.4. Data logger settings

Home → Settings → Logger settings

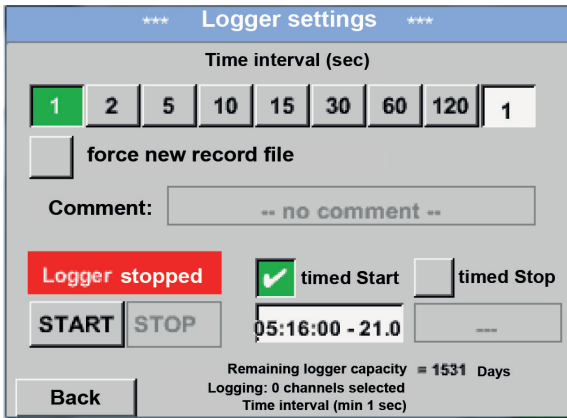

In the top row, select one of the pre-defined Intervals (1, 2, 5, 10, 15, 30, 60, and 120 seconds) for recording.

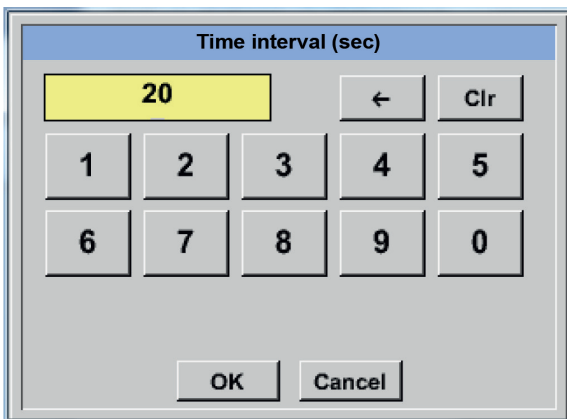

Alternatively, enter a user-defined Interval in the white text field in the top right corner showing the currently selected Interval (here: 20 seconds).

**Notice:**  
The longest possible Interval is 300 seconds (5 minutes).

**Notice:**

If more than 12 measurements are recorded simultaneously, the shortest possible data logger interval is 2 seconds.

If more than 25 measurements are recorded simultaneously, the shortest possible data logger interval is 5 seconds.

Home → Settings → Logger settings → Enforce new logger file button

or

Home → Settings → Logger settings → Enforce new logger file button → Comment

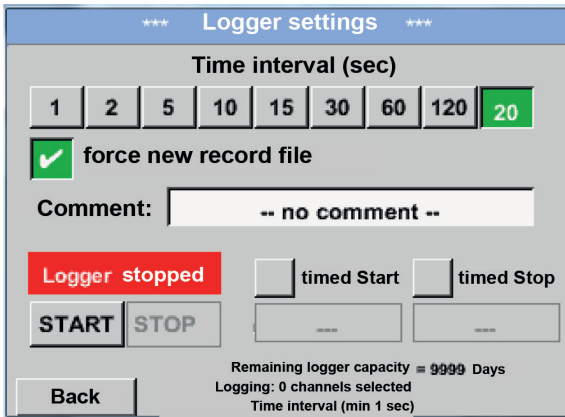

Check the **Enforce new logger file** box to create a new recording file with the name/comment entered in the **Comment** text field.

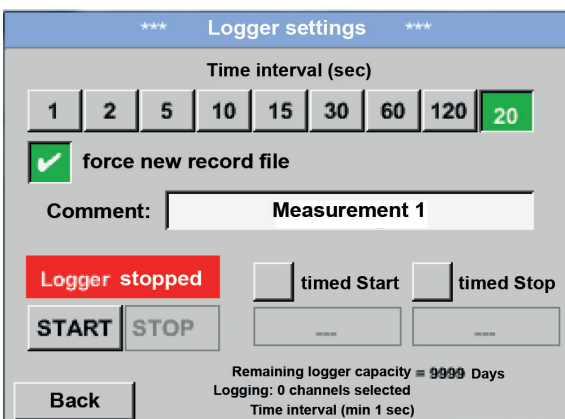

**Important:**

If a new logger (recording) file is to be created, check the **Enforce new logger file** box.

Otherwise, the last created logger (recording) is used.

Home → Settings → Logger settings → Start time button

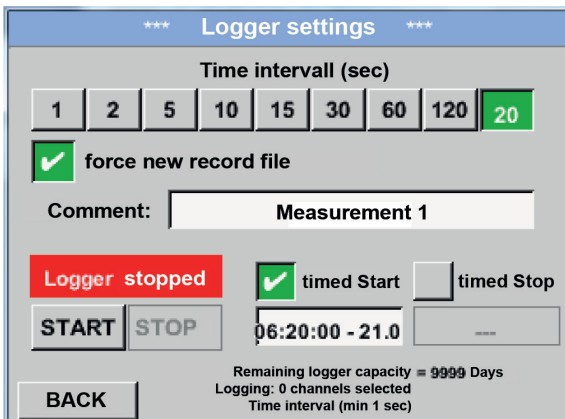

Check the **Start time** box and enter the start date/time for the data logger recording in the fields below the box.

**Notice:**

When the **Start time** box is checked, the current time plus 1 minute is displayed in the date/time field.

Home → Settings → Logger settings → Stop time button

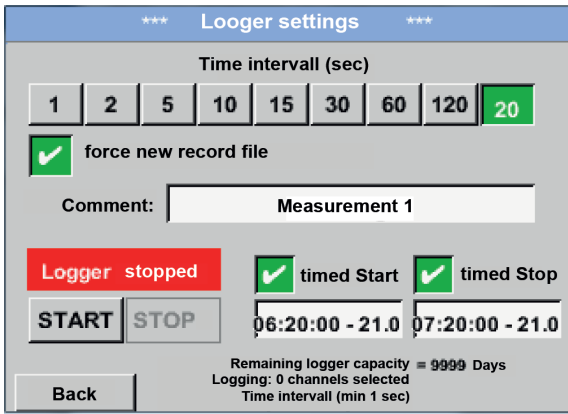

Check the **Stop time** box and enter the stop date/time for the data logger recording in the fields below the box.

**Notice:**

When the **Stop time** box is checked, the current time plus 1 hour is displayed in the date/time field.

Home → Settings → Logger settings → Start time button/Stop time button → Date/time

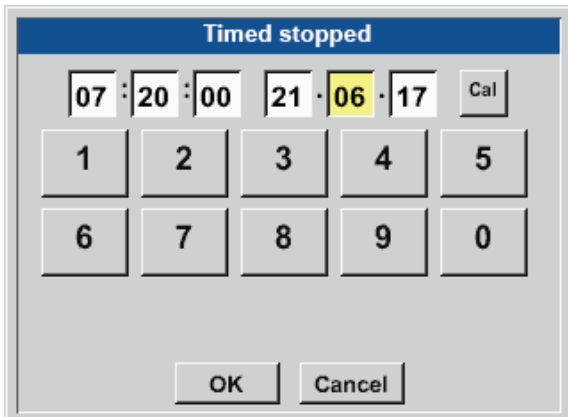

Touch the **Date/time** text field. A window where you can enter the date and time by entering the relevant values in the yellow box.

Home → Settings → Logger settings → Start time button/Stop time button → Date/time → Calendar button



Press the **Calendar** button to select the date from the calendar.

Home → Settings → Logger settings → Start time button

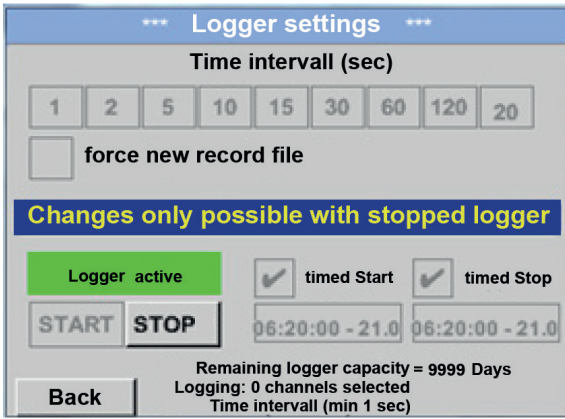

After the **Start time** and/or **Stop time** has been set, press the **Start** button to set the data logger to **active**.

The data logger will start recording at the set time!

Home → Settings → Logger settings → Start button/Stop button

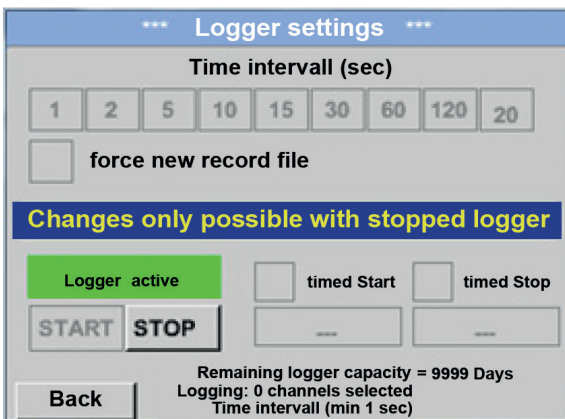

The data logger can also be started and stopped without time settings. To do this, simply press the **Start** and **Stop** button. The field in the bottom left corner indicates the number of values that are recorded and the remaining recording time.

**Notice:**  
The settings cannot be changed while the data logger is recording.

**Important:**

If a new logger (recording) file is to be created, check the **Enforce new logger file** box. Otherwise, the last created logger (recording) is used.



### 11.5. Charts

Home → Charts

**Caution:**

Only recordings that are completed can be viewed in the form of charts!

Currently running recordings can be viewed with [Chart/current values](#) (see chapter 11.5.1 Chart/real time values).

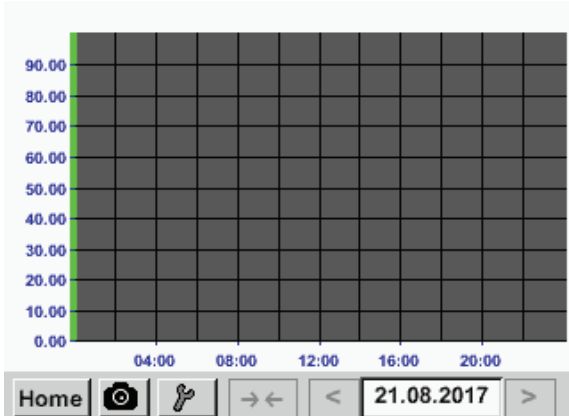

While a measurement is running, no values are displayed!

Zooming and scrolling in [Charts](#):



The maximum time period that can be viewed in a chart is 1 day (24h).



The shortest possible interval in the recording is displayed.

Additional zooming and scrolling options in [Charts](#) and [Chart/current values](#):

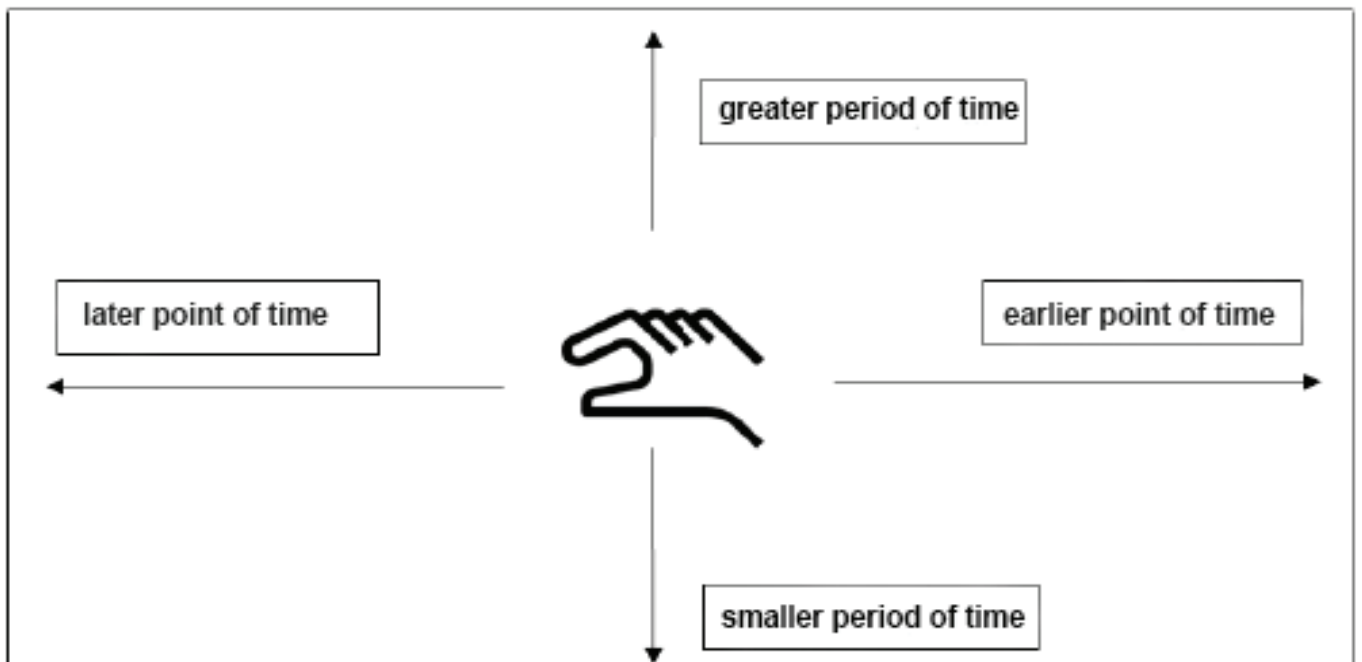

Home → Chart → Date

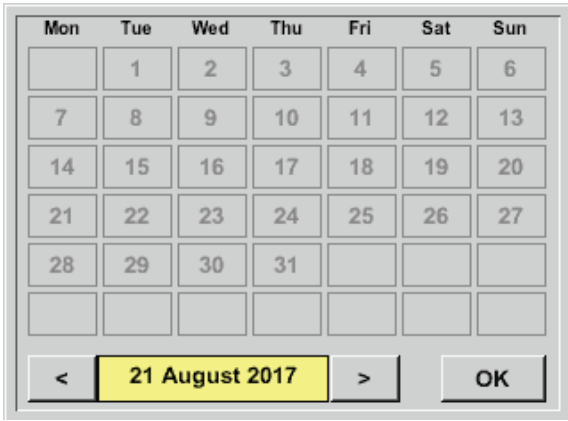

Press the **Date** field to call up a calendar where you can select the desired date.

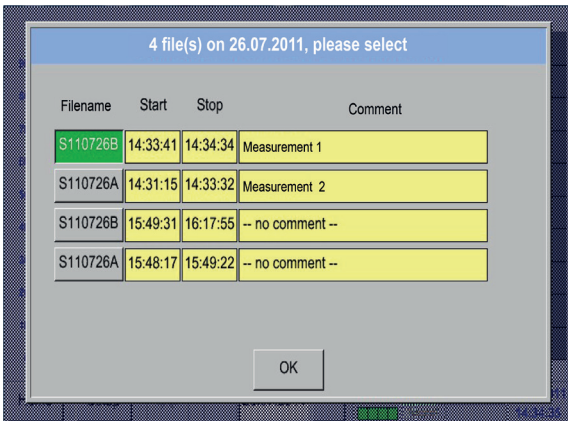

Select saved measurements by **Time** (Start and Stop time), by **Comment** and/or by **File name** (contains date in UK format).

Home → Chart → Tool Button

In the **Setup** menu, you can configure two y-axes and select the **Unit**, the y-axis scale (**min**, **max**, **grid**), multiple channels (**curves**), and the **colour** to be displayed.

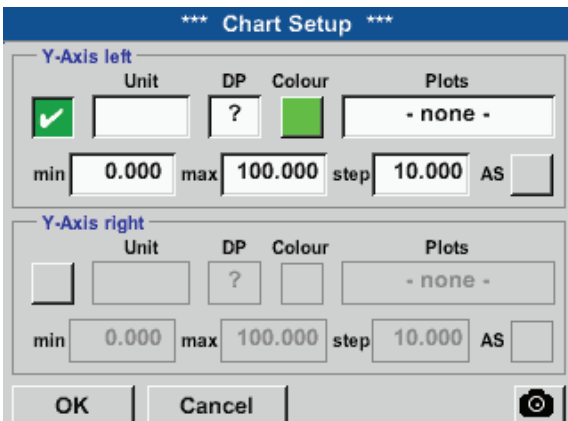

1. The **left 1.** y-axis is selected. You can now assign a **Colour** to it.

**Notice:**

While the grid settings can already be made at this point, it is generally more useful to make them at a later stage, for instance after a recording has been selected!

Home → Chart → Setup → Unit

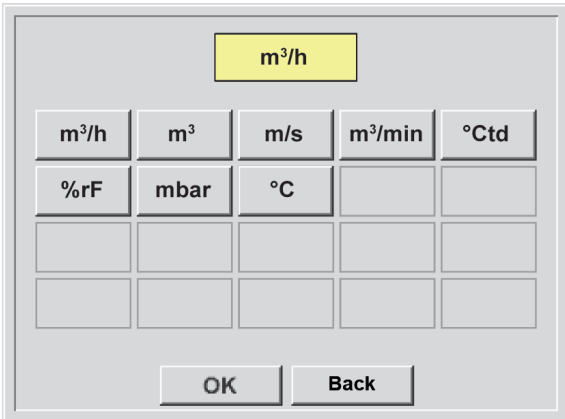

Select the Unit of the recording to be displayed.

Home → Charts → Tool Button

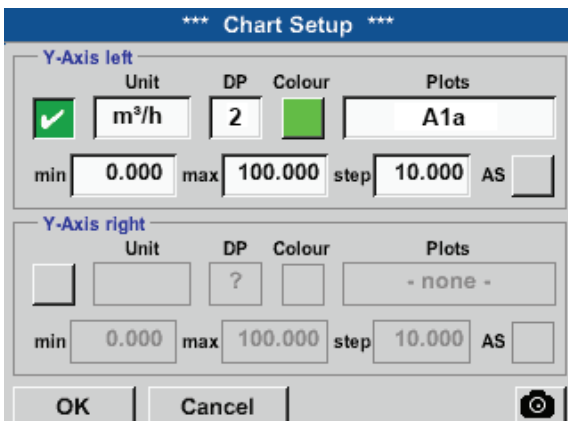

Select the y-axis scaling with min., max. and grid. Press the A.Scale button to define calculation-based automatic scaling.

To configure the other y-axes, proceed as described above!

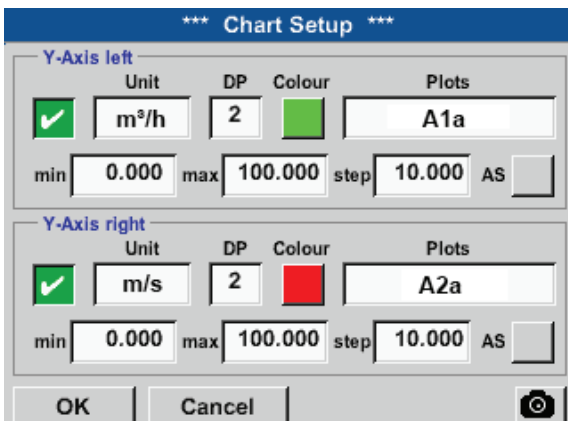

Four different grid settings with different Units and Colours.

Home → Charts

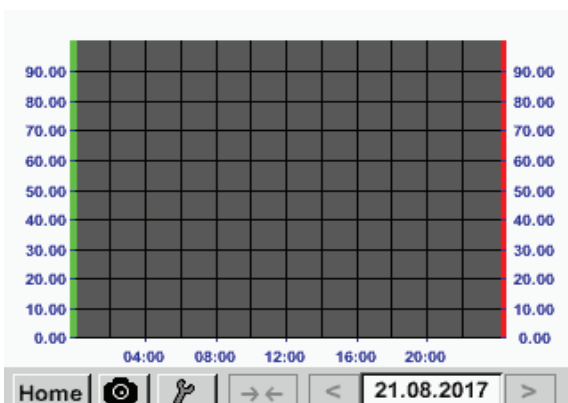

Press the OK button to confirm input and return to the graphic display.

### 11.5.1. Chart/Real time values

Home → Chart/Real time values

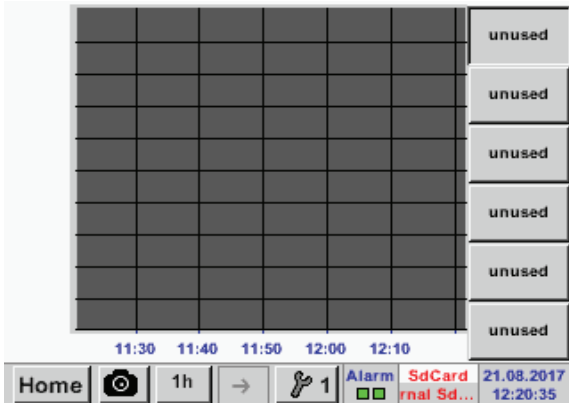

One or more channels for the recording and the visualisation of the measurements can be selected here (e.g. on dew point sensor or a number of different sensors).

Home → Chart/Real time values → #1-#6 → Tool Button

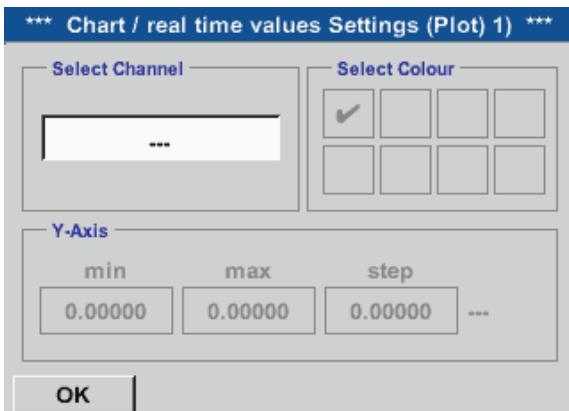

Select this menu option to simultaneously activate and view up to 4 channels (depending on your METPOINT® BDL compact version) in *Home → Chart/Real time values*

Home → Chart/Real time values → #1-#6 → Tool Button → Select Channel

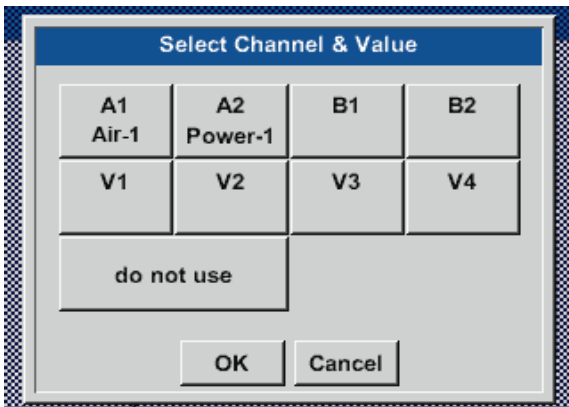

Under Select channel you select the respective channel. The channel A1 Air-1 was selected here.

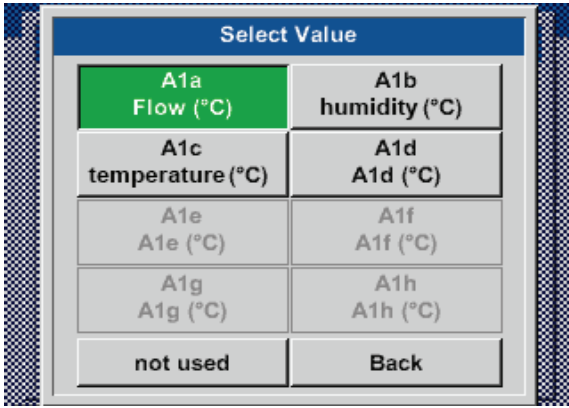

For each channel a value can be selected for display in the **Chart**.

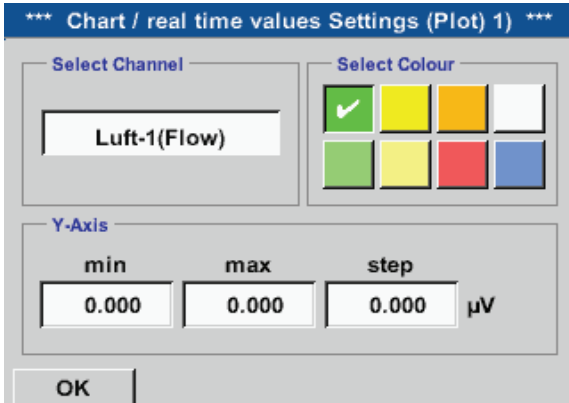

Here: channel A1 has been selected. For each channel, select a value for visualisation in the **Chart**, and one value to be displayed. In addition, you can define a **Colour** and the y-axis scaling factors (**min**, **max**, **Raster**) in *Home*  $\rightarrow$  *Chart*.

Home  $\rightarrow$  Chart/Real time values

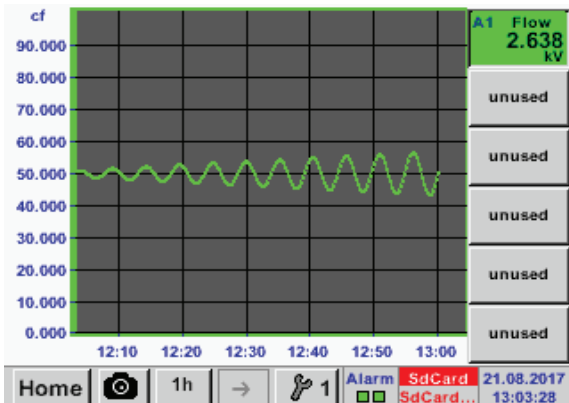

**Channel A1:**  
In the example, the flow volume has been selected for the **Chart**.  
If more than one channel has been selected, all related charts are displayed. Please note that only the y-axis of the selected channel is displayed.  
When no y-axis scaling is entered in the setup, **min.** is set to 0, **max.** is set to 100, and **grid** is set to 10.

Proceed as described above to configure all other setups!

Home → Channels

<b>A1 Air-1</b>		<b>A2 Power-1</b>	
Flw	5 °C	P	- 40 °Ctd
RF	30 %		
Tmp	10 °C		
A1d	10 °C		
<b>B1</b>		<b>B2</b>	
B1a	5 °Ctd	B2a	- 60 °Ctd
B1b	- 5 °Ctd		
B1c	- 45 °Ctd		
Home		Virtual Ch.	Alarm   SdCard 06.03.2017 12:36:11

The **Current values** menu shows the current measurements of all the connected sensors. If a set alarm limit has been exceeded, the respective measured value flashes in yellow (**Alarm 1**) or red (**Alarm 2**).

Home → Channels → A1

*** Channel A1 ***			- 0.0 V
			- 0 mA
Type	VA5xx	Name	Air-1
Record		Alarm	
<input type="checkbox"/>	Flow	0.200 ltr/min	<input type="checkbox"/>
<input type="checkbox"/>	Humidity	30 %	<input type="checkbox"/>
<input type="checkbox"/>	Temperature	10 °C	<input type="checkbox"/>
<input type="checkbox"/>	A1d	1 ltr/min	<input type="checkbox"/>
Back	Store	Min/Max	

You have the option to select a channel to call up and check the settings. It is however not possible to change the settings here.

**Notice:**

Changes to the settings must always be made in the **Settings** menu!

### 11.6. Current values

Home → Current values

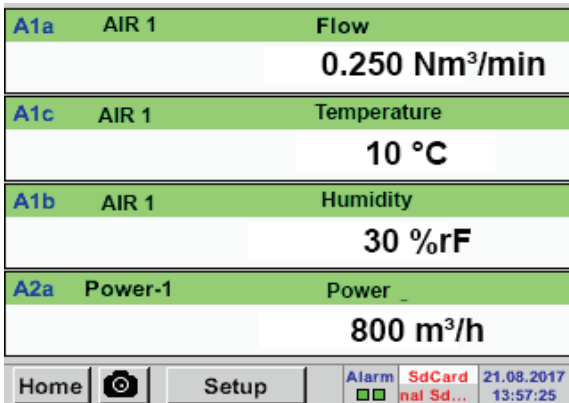

The **Current values** view allows for the display of up to 5 user-defined measurements. If a set alarm limit has been exceeded, the respective measured value flashes in yellow (**Alarm 1**) or red (**Alarm 2**).

**Notice:**

Changes to the layout must always be made in the **Setup** menu!

Home → Current values → Setup → next Layout

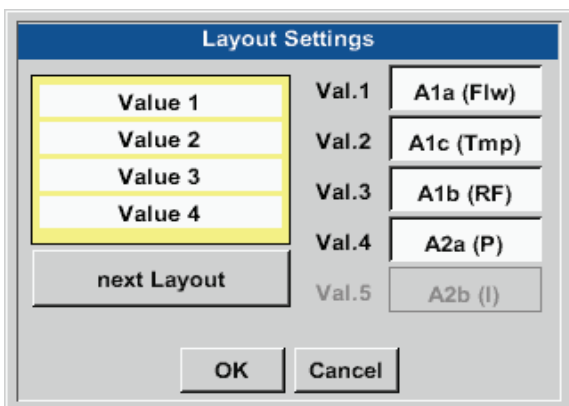

Press the **next Layout** button to select a layout. You can choose between 6 layouts that allow for the display of up to 5 measurements. For available options, see below. Press a white field (**Val.1 to Val.5**) to select the measurements to be displayed.

Available layout options:

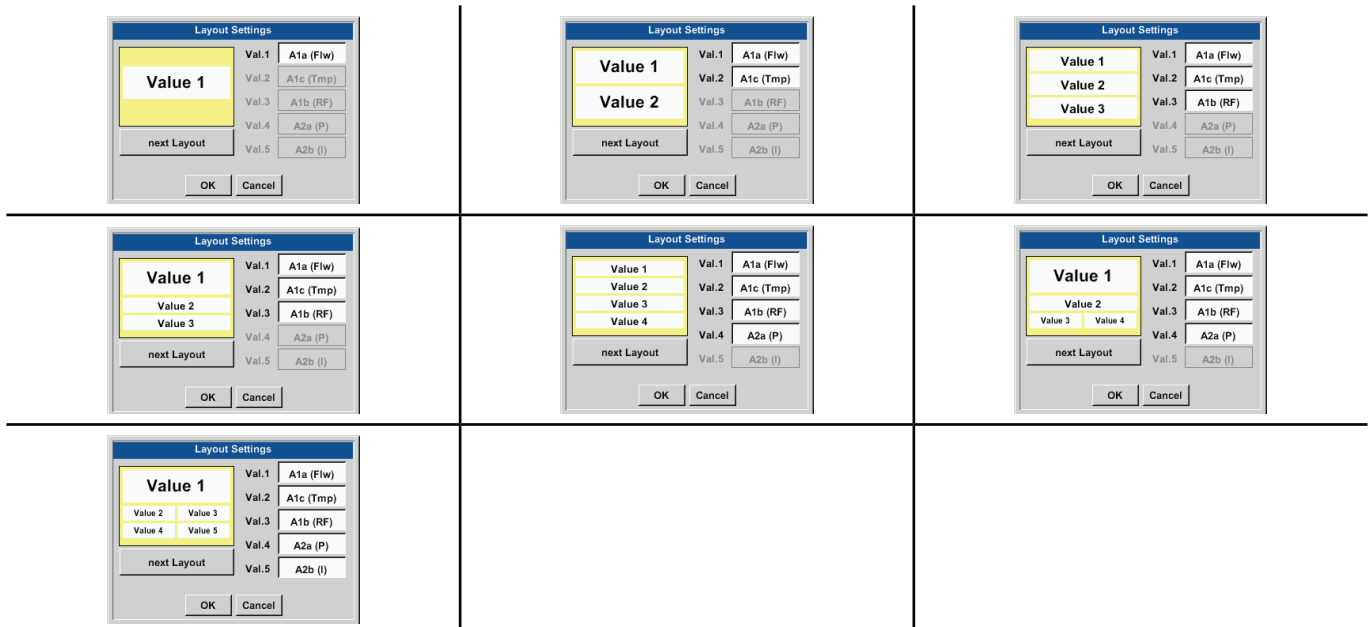

### 11.7. Alarm overview

Home → Alarm overview

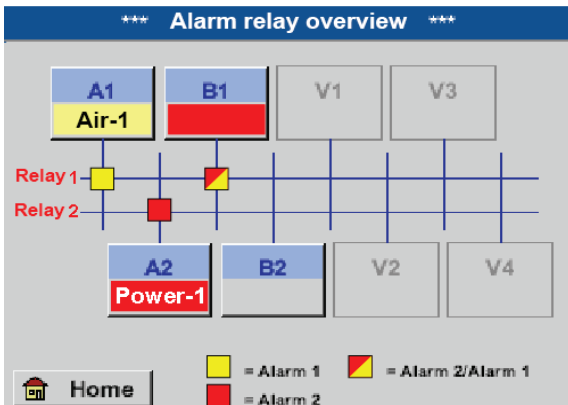

In the alarm overview, you can immediately see whether the alarm is an **Alarm 1** or an **Alarm 2**. The type of the alarm is also shown in other menu: [Home → Channels](#) and [Home → Settings → Sensor settings](#). The channel name field flashes in yellow for an **Alarm 1** and red for an **Alarm 2**. In addition, the relays that have been set for the channels for Alarm 1 and/or Alarm 2 are indicated by yellow and red or red/yellow squares at the intersections between the measuring channel and the relays.

In the example, there is an **Alarm 1** at channel A1 and an **Alarm 2** at channels A2 and B1!

Home → Alarm overview → A1

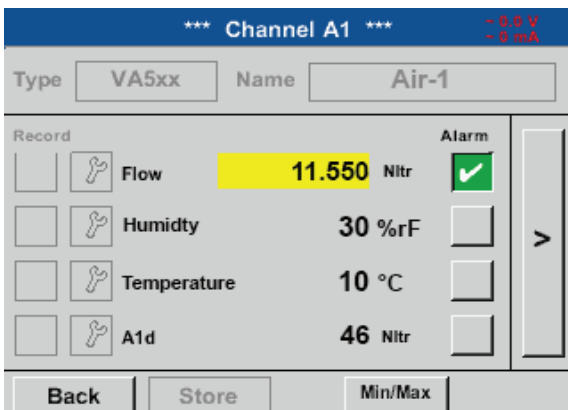

As in [Home → Channels](#), you can select an individual channel. In the **Alarm overview**, the measurement that has triggered the alarm can be quickly identified.

**Notice:**

In this menu, you can set and edit the alarm parameters.

### 11.8. Export/Import

This menu allows you to export stored data to a USB memory stick.

Home → Export/Import

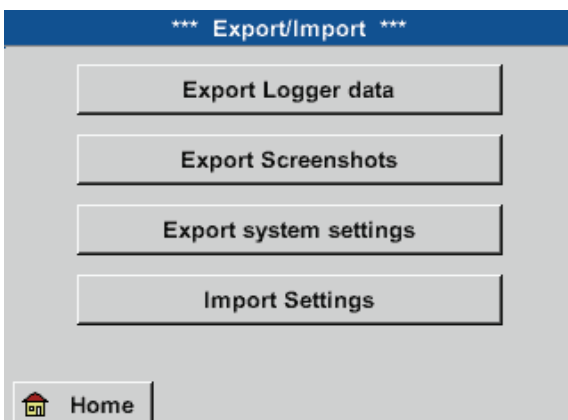

Press the **Export logger data** and **Export system settings** buttons to export the measuring data as well as the settings to a USB memory stick.



Home → Export data → Export logger data

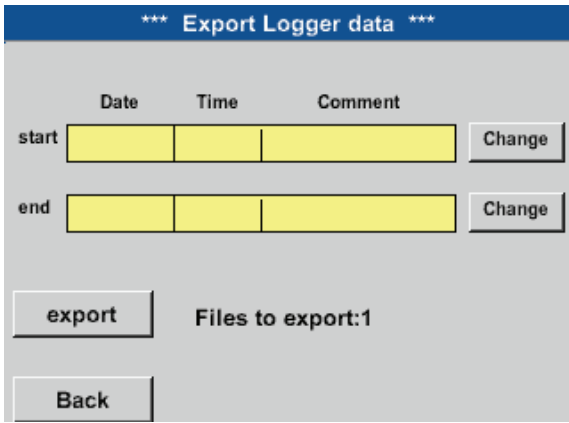

Press the **Select** buttons to select the **Start** and **End** time of the period you wish to export. The stored bitmaps captured within the set period are exported.

Home → Export data → Export logger data → change

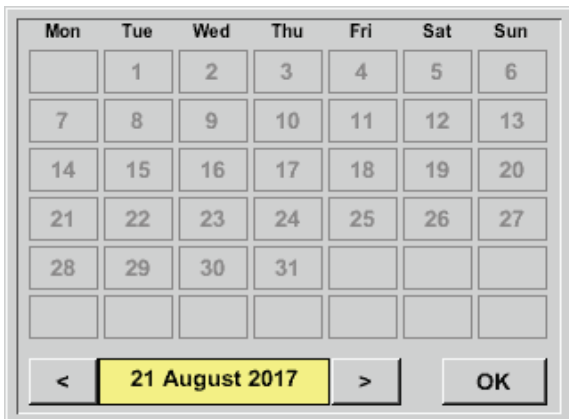

The selected date is highlighted in green. Sundays are highlighted in red.

The buttons of dates for which there are measuring data are raised.

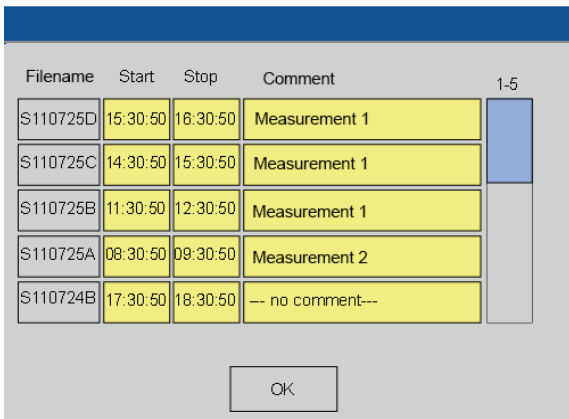

If there are several measurements for a date, they are listed after you have confirmed the selected date with OK.

Select the desired record from the list.

Home → Export/Import → Export logger data → Export

The measuring data of the selected period are exported to a USB memory stick.

Home → Export/Import → Export system settings

Press the Export system settings button to export all existing sensor settings to a USB memory stick.

Home → Export/Import → Import system settings

With the help of Import system settings, previously exported sensor settings can be imported via a USB stick or an SD card.

### 11.9. Screenshot function

This function allows you to store screenshots of charts, charts/current values, channels and current values on an USB memory stick or a SD card.

#### 11.9.1. Saving screenshots

- Home → Charts →
- Home → Chart/current values →
- Home → Channels →
- Home → Current values →

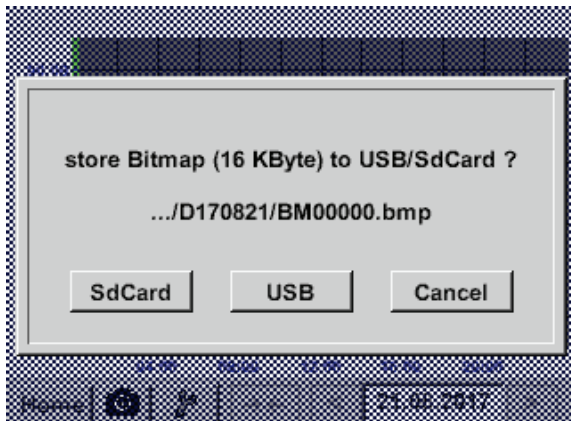

Select the USB memory stick or SD card on which you wish to store the screenshots.

The images are stored with an incremental number in day-specific folders.

Folder name;                    DJJMMTT  
 D=fixed (for Date)  
 JJ = year  
 MM= month  
 TT= day

Path: DEV0002/Hostname/Bitmap  
 For host name, see  
[Home → Settings → System overview](#)  
 Example: first screenshot taken on 10 September 2013:  
 \\DEV0002/DE-4001/Bitmap/D130910/B00000.bmp

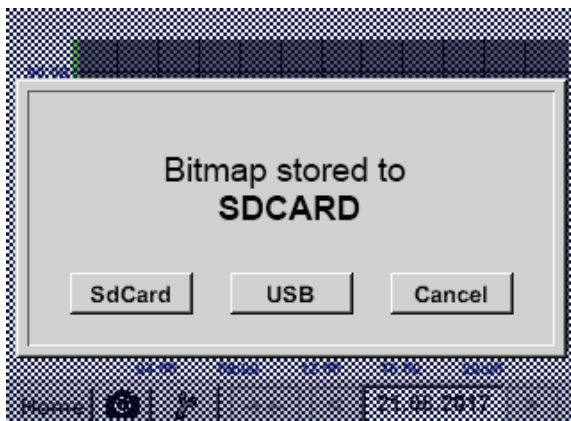

#### 11.9.2. Exporting screenshots

The screenshots saved on the SD card can be stored on a USB memory stick.

[Home → Export/Import](#)

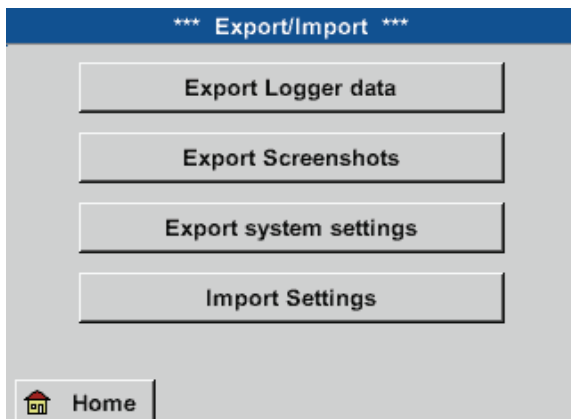

The [Export screenshots](#) menu allows you to export stored data to a USB memory stick.

Home → Export/Import → Export screenshots

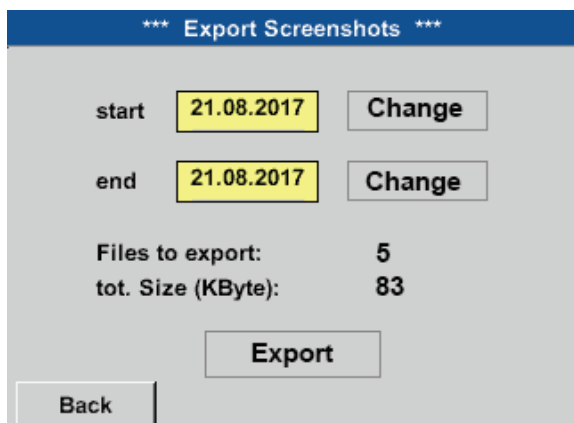

Press the Select buttons to select the Start and End time of the period you wish to export. The stored bitmaps captured within the set period are exported.

Home → Export/Import → Export screenshots → Change

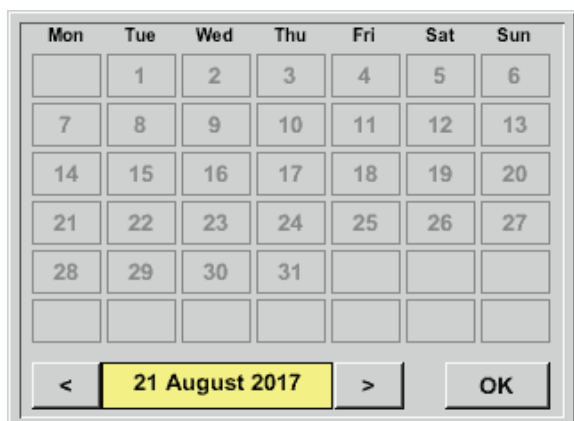

The selected date is highlighted in green. Sundays are highlighted in red.

The buttons of dates for which there are measuring data are raised.

Home → Export/Import → Export screenshots → Export

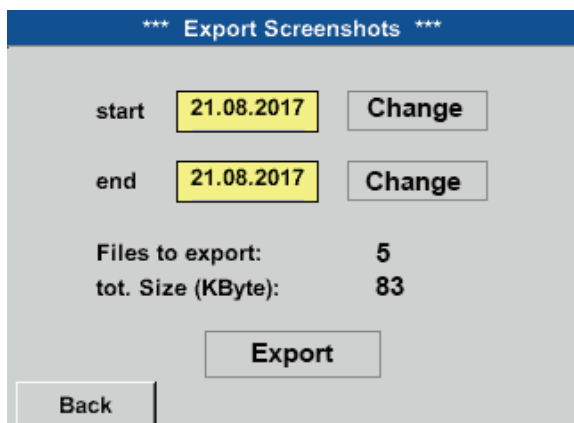

The screenshots of the selected period are exported to a USB memory stick.

## 12. SD card and batteries

To store measurements for subsequent processing, the METPOINT® BDL compact features a SD card slot. An integrated battery (button cell) ensures that the configuration data is not lost when the device is shut down.

<b>DANGER</b>	<b>Battery and SD card</b>
	The battery and the SD card must be changed by authorised skilled technical personnel of BEKO. Before changing the battery or SD card, ensure that the device is de-energised.

<b>Danger!</b>	<b>Risk of damage from ESD</b>
	The device contains electronic components that might be damaged or even destroyed by electrostatic discharge (ESD).

### Preventive measures

For maintenance and service work that requires you to open the housing of the device, observe the instructions in chapter „8.1.1. Prevention of electrostatic discharge (ESD)“ to prevent damage from electrostatic discharge.

### 13. Cleaning/decontamination

<b>NOTICE</b>	<b>Observe display during cleaning</b>
	The METPOINT® BDL compact has a cleaning function which protects the display against unintentional operation when cleaning it. For details, see chapter „11.2.5. Cleaning“ page 76.

To clean the METPOINT® BDL compact plug-on display, use a damp (but not wet) cotton cloth or disposable tissue and a mild conventional detergent.

To decontaminate the device, spray the decontamination product on a clean cotton cloth or disposable wipe and thoroughly wipe the device. Then dry the device with a clean cloth or let it dry at room temperature.

Observe the locally applicable hygiene regulations.

<b>WARNING</b>	Risk of damage to device
	Excessive humidity, the use of hard and pointed implements and aggressive cleaners can cause damage to the data logger and to the integrated electronic components.

#### Preventive measures

- Never clean the device with a wet cloth.
- Do not use aggressive detergents.
- Do not clean or operate the device with hard or pointed implements.



## 14. Dismantling and disposal

Disposal of the device according to the WEEE Directive (Waste Electrical and Electronic Equipment): Electrical and electronic waste must not be disposed as normal household waste.

To dispose of the product, dismantle it. Materials such as glass, plastics and some chemical compounds are, recoverable, reusable, or recyclable.

According to §5, section 1 of the German Electrical and Electronic Equipment Act (ElektroG), the METPOINT® BDL compact is classified in category 9 and not subject to any restrictions regarding hazardous substances. According to §9, section 7 (ElektroG), the METPOINT® BDL compact from BEKO TECHNOLOGIES GmbH can be returned to the manufacturer for disposal.

If the BDL compact is not returned to BEKO TECHNOLOGIES GmbH for disposal, dispose of it according to waste code:

<p><b>20 01 36</b></p>	<p>Discarded electrical and electronic equipment other than those mentioned in 20 01 21, 20 01 23 and 20 01 35.</p>
	<p>The batteries must be disposed of separately according to the relevant statutory waste disposal regulations.</p>
<p><b>WARNING</b></p>	<p><b>Risk to health and the environment!</b></p>
	<p>Never dispose of the device with normal household waste! Depending on the medium used in the device, it might be contaminated with residues that can pose a risk to health and the environment. Therefore, take suitable protective measures and dispose of the device through the proper channels.</p>

### Actions:

When dismantling components, clean them without delay to remove any medium residue.



## 15. Declaration of Conformity

BEKO TECHNOLOGIES GMBH  
 Im Taubental 7  
 41468 Neuss, GERMANY  
 Tel: +49 2131 988-0  
 www.beko-technologies.com



### EU-Konformitätserklärung

Wir erklären hiermit, dass die nachfolgend bezeichneten Produkte den Anforderungen der einschlägigen Richtlinien und technischen Normen entsprechen. Diese Erklärung bezieht sich nur auf die Produkte in dem Zustand, in dem sie von uns in Verkehr gebracht wurden. Nicht vom Hersteller angebrachte Teile und/oder nachträglich vorgenommene Eingriffe bleiben unberücksichtigt.

Produktbezeichnung:	<b>METPOINT® BDL compact</b>
Spannungsversorgung:	100 ... 240 VAC / 1Ph. / PE / 50-60 Hz
IP-Schutzart	IP44
Umgebungstemperatur:	0 ... +50°C
Datenblatt:	DB_BDLc-0814-FP-A
Produktbeschreibung und Funktion:	Datenlogger zur stationären Messdatenerfassung und Speicherung, für industrielle Anwendungen.

#### Niederspannungs-Richtlinie 2014/35/EU

Angewandte harmonisierte Normen: EN 61010-1:2010

#### EMV-Richtlinie 2014/30/EU

Angewandte harmonisierte Normen: EN 61326-1:2013

#### ROHS II-Richtlinie 2011/65/EU

Die Vorschriften der Richtlinie 2011/65/EU zur Beschränkung der Verwendung bestimmter gefährlicher Stoffe in Elektro- und Elektronikgeräten werden erfüllt.

Die Produkte sind mit dem abgebildeten Zeichen gekennzeichnet:



Die alleinige Verantwortung für die Ausstellung dieser Konformitätserklärung trägt der Hersteller.

Neuss, 20.04.2016

Unterzeichnet für und im Namen von:

**BEKO TECHNOLOGIES GMBH**

i.V. Christian Riedel

Leiter Qualitätsmanagement International



**BEKO TECHNOLOGIES GMBH**  
 Im Taubental 7  
 41468 Neuss, GERMANY  
 Phone: +49 2131 988-0  
 www.beko-technologies.com



## EU Declaration of Conformity

We hereby declare that the products indicated hereafter comply with the stipulations of the relevant directives and technical standards. This declaration only refers to products in the condition in which they have been placed into circulation. Parts which have not been installed by the manufacturer and/or modifications which have been implemented subsequently remain unconsidered.

Product designation:	<b>METPOINT® BDL compact</b>
Power supply:	100 ... 240 VAC / 1-phase / PE / 50-60 Hz
Degree of protection	IP44
Operating ambient temperature:	0...+50°C
Data sheet:	DB_BDLc-0814-FP-A
Product description and function:	Data logger for stationary data recording and storage; designed for industrial applications

### **Low Voltage Directive 2014/35/EU**

Applied harmonized standards: EN 61010-1:2010

### **EMC Directive 2014/30/EU**

Applied harmonized standards: EN 61326-1:2013

### **RoHS II Directive 2011/65/EU**

The products meet the requirements laid down in European Directive 2011/65/EU concerning the restriction of the use of certain hazardous substances in electrical and electronic devices.

The products bear the CE Mark:



This Declaration of Conformity has been issued by the manufacturer.

Neuss, 20/04/2016

Signed:  
**BEKO TECHNOLOGIES GMBH**

ppa Christian Riedel  
 Head of International Quality Management

**BEKO TECHNOLOGIES GmbH**

Im Taubental 7  
 D - 41468 Neuss  
 Tel. +49 2131 988 0  
 Fax +49 2131 988 900  
 info@beko-technologies.com

**DE****BEKO TECHNOLOGIES LTD.**

Unit 11-12 Moons Park  
 Burnt Meadow Road  
 North Moons Moat  
 Redditch, Worcs, B98 9PA  
 Tel. +44 1527 575 778  
 info@beko-technologies.co.uk

**GB****BEKO TECHNOLOGIES S.à.r.l.**

Zone Industrielle  
 1 Rue des Frères Rémy  
 F - 57200 Sarreguemines  
 Tél. +33 387 283 800  
 info@beko-technologies.fr

**FR****BEKO TECHNOLOGIES B.V.**

Veenen 12  
 NL - 4703 RB Roosendaal  
 Tel. +31 165 320 300  
 benelux@beko-technologies.com

**NL****BEKO TECHNOLOGIES  
(Shanghai) Co. Ltd.**

Rm. 606 Tomson Commercial Building  
 710 Dongfang Rd.  
 Pudong Shanghai China  
 P.C. 200122  
 Tel. +86 21 508 158 85  
 info.cn@beko-technologies.cn

**CN****BEKO TECHNOLOGIES s.r.o.**

Na Pankraci 58  
 CZ - 140 00 Praha 4  
 Tel. +420 24 14 14 717 /  
 +420 24 14 09 333  
 info@beko-technologies.cz

**CZ****BEKO Tecnológica España S.L.**

Torruella i Urpina 37-42, nave 6  
 E - 08758 Cervelló  
 Tel. +34 93 632 76 68  
 Mobil +34 610 780 639  
 info.es@beko-technologies.es

**ES****BEKO TECHNOLOGIES LIMITED**

Unit 1010 Miramar Tower  
 132 Nathan Rd.  
 Tsim Sha Tsui Kowloon Hong Kong  
 Tel. +852 5578 6681 (Hong Kong)  
 +86 147 1537 0081 (China)  
 tim.chan@beko-technologies.com

**HK****BEKO TECHNOLOGIES INDIA Pvt. Ltd.**

Plot No.43/1 CIEEP Gandhi Nagar  
 Balanagar Hyderabad  
 IN - 500 037  
 Tel. +91 40 23080275 /  
 +91 40 23081107  
 Madhusudan.Masur@bekoindia.com

**IN****BEKO TECHNOLOGIES S.r.l**

Via Peano 86/88  
 I - 10040 Leini (TO)  
 Tel. +39 011 4500 576  
 Fax +39 0114 500 578  
 info.it@beko-technologies.com

**IT****BEKO TECHNOLOGIES K.K**

KEIHIN THINK Building 8 Floor  
 1-1 Minamiwatarida-machi  
 Kawasaki-ku, Kawasaki-shi  
 JP - 210-0855  
 Tel. +81 44 328 76 01  
 info@beko-technologies.jp

**JP****BEKO TECHNOLOGIES Sp. z o.o.**

ul. Pańska 73  
 PL - 00-834 Warszawa  
 Tel. +48 22 314 75 40  
 info.pl@beko-technologies.pl

**PL****BEKO TECHNOLOGIES S.E.Asia  
(Thailand) Ltd.**

75/323 Soi Romklao, Romklao Road  
 Sansab Minburi  
 Bangkok 10510  
 Tel. +66 2-918-2477  
 info.th@beko-technologies.com

**TH****BEKO TECHNOLOGIES CORP.**

900 Great Southwest Pkwy SW  
 US - Atlanta, GA 30336  
 Tel. +1 404 924-6900  
 Fax +1 (404) 629-6666  
 beko@bekousa.com

**US**

Translation of the original instructions. Original instructions are in German.

mp\_bdlc\_ba\_10-089\_en\_11\_01

[www.beko-technologies.com](http://www.beko-technologies.com)

