

8 7 6 5 4 3 2 1

D

D

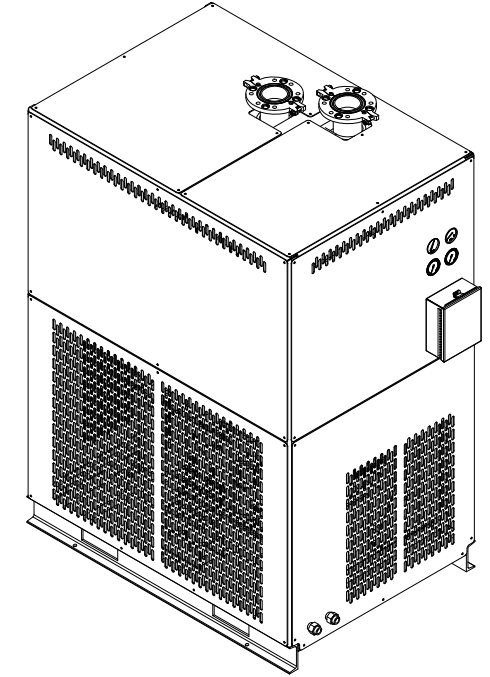
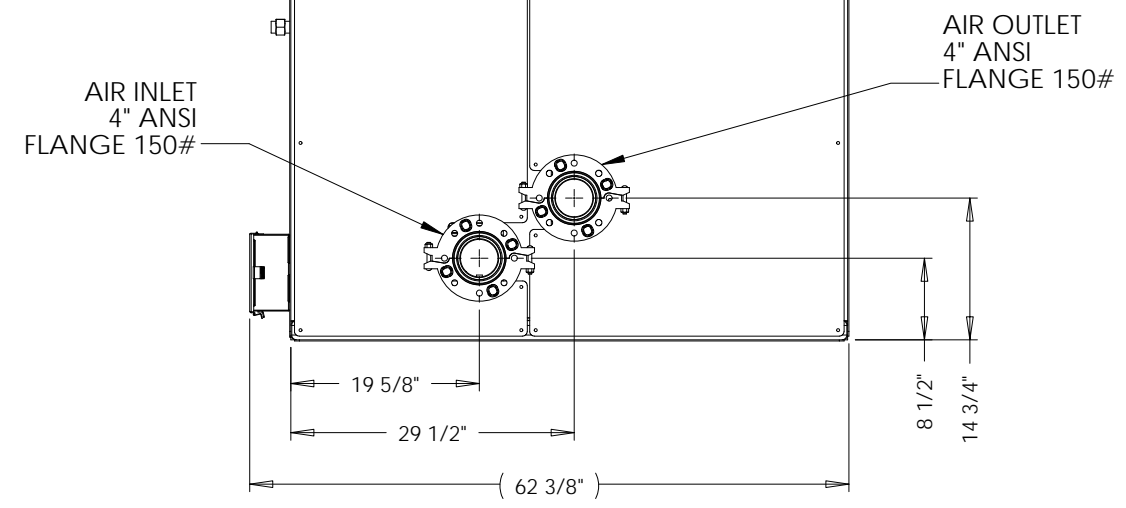
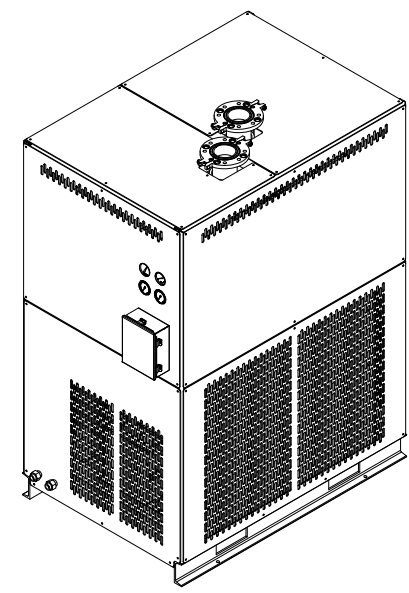

C

C

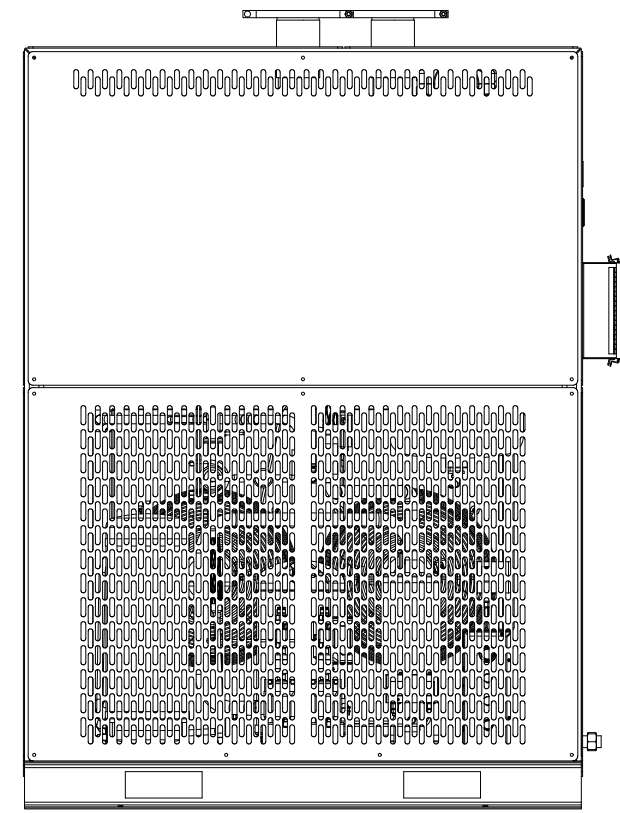
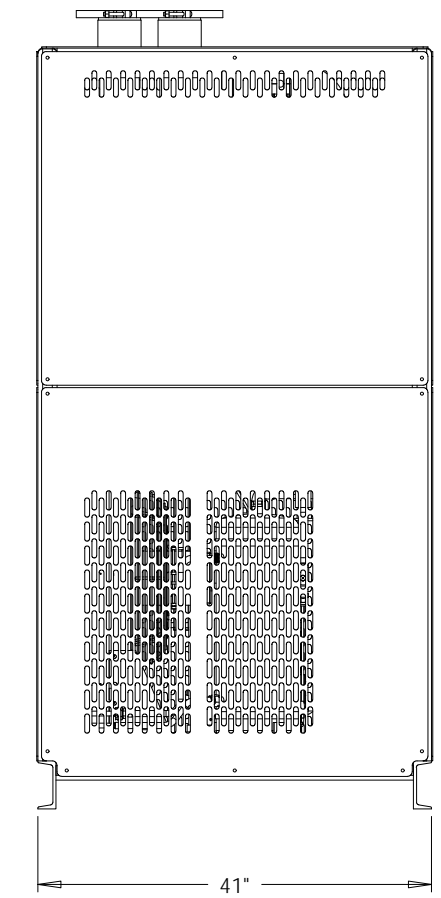
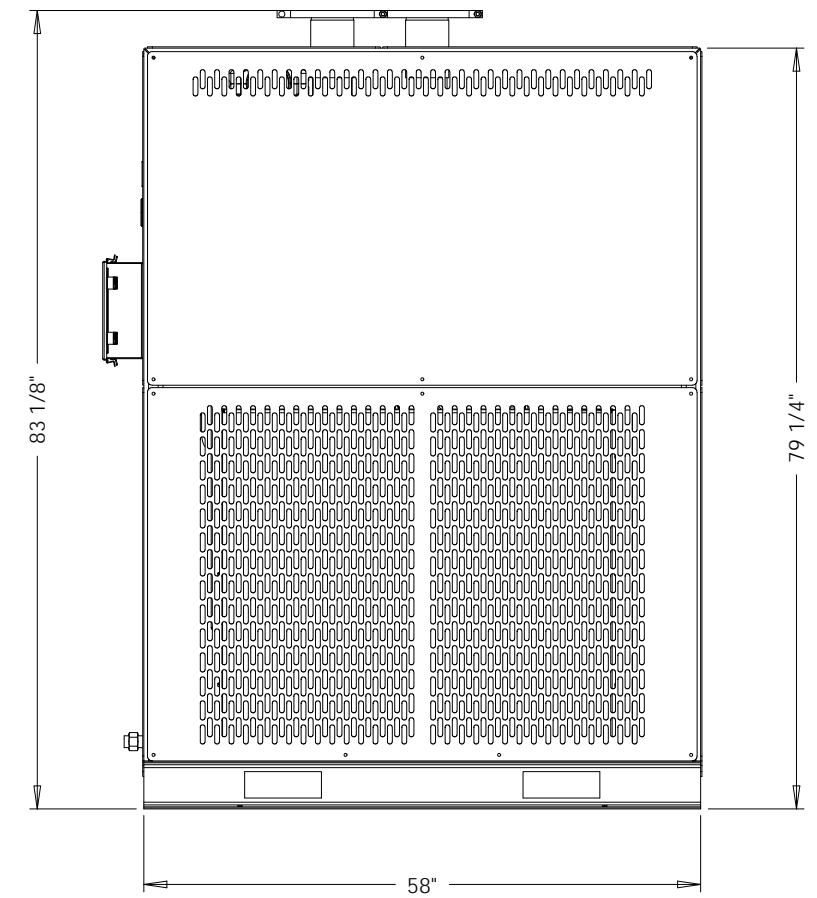
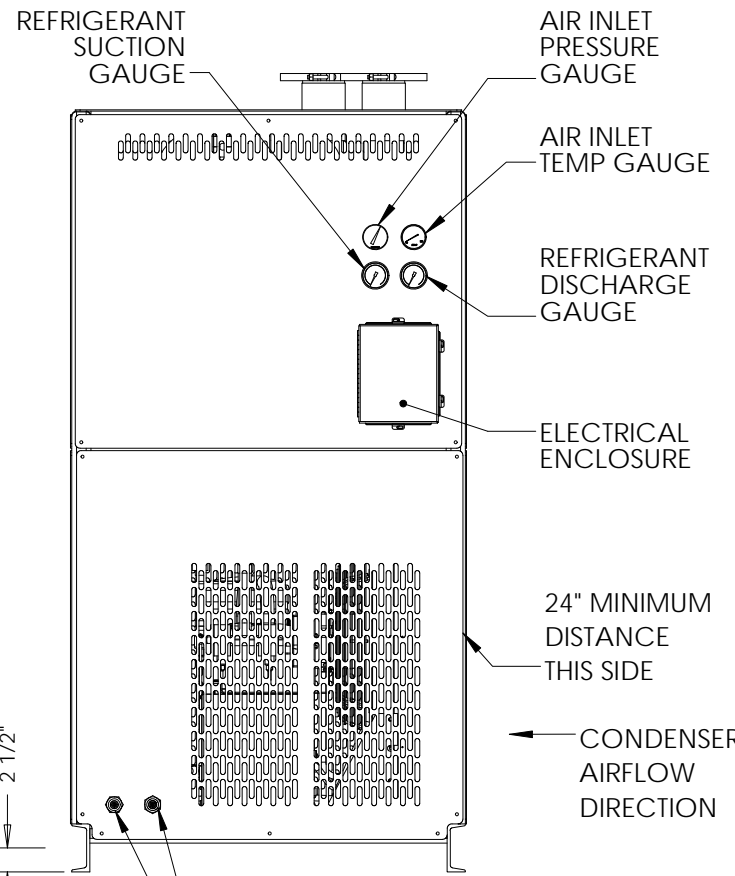

B

B

A

A

UNLESS OTHERWISE SPECIFIED:
DIMENSIONS ARE IN INCHES
TOLERANCES:
FRACTIONAL ± 0.125
ANGULAR: ±0.5°
TWO PLACE DECIMAL ± .03
THREE PLACE DECIMAL ± .003

THIRD ANGLE PROJECTION

MATERIAL

FINISH

DO NOT SCALE DRAWING

	NAME	DATE
DRAWN	BH	05/09/17
CHECKED	JJ	05/09/17
ENG APPR.		
MFG APPR.		
Q.A.		
COMMENTS:		

Aircel COMPRESSED AIR AND GAS PRODUCTS
323 CRISP CIRCLE
MARYVILLE TENNESSEE 37801
PHONE: 865-681-7066
FAX: 865-681-7069

TITLE: VF-2000, REFRIGERATED AIR DRYER, 2000 SCFM, 100 PSIG, 100F

SIZE	DWG. NO.	REV
B	AG3024101	0
SCALE: 1:50	WEIGHT:	SHEET 1 OF 1

PROPRIETARY AND CONFIDENTIAL
THE INFORMATION CONTAINED IN THIS DRAWING IS THE SOLE PROPERTY OF AIRCEL LLC. ANY REPRODUCTION IN PART OR AS A WHOLE WITHOUT THE WRITTEN PERMISSION OF AIRCEL LLC IS PROHIBITED.

8 7 6 5 4 3 2 1